



# Algemene catalogus

2020

NEDERLAND

**niko**  
Illuminating ideas.





# Schakelmateriaal en wandcontactdozen

- D.1 Inbouwschakelmateriaal
- D.2 Medianetwerk
- D.3 Niko opbouwkit
- D.4 Niko Hydro
- D.5 Installatiekanalen
- D.6 Technische info





# Inbouwschakelmateriaal

## Ingenieus in techniek

De Niko schakelaars en wandcontactdozen zetten de standaard en zijn van oerdegelijke kwaliteit. Ze zijn duurzaam, robuust en eenvoudig te installeren. We testen al onze materialen om minstens 30 jaar mee te gaan bij extreme belasting.

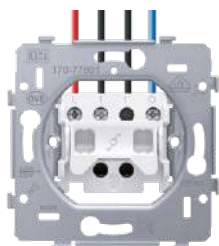

### VOORDELEN

#### Snel en gemakkelijk geïnstalleerd

- alle aansluitklemmen zitten aan de bovenzijde van de sokkel
  - je stript en knipt alle draden eenvoudig op gelijke lengte
  - je hebt meer plaats om de draden te plooien en het mechanisme in de inbouwdoos te plaatsen
- aansluitschema, schakelsymbool en klemidentificatie in onuitwisbare inkt
- gemakkelijk op de sokkel af te meten ontmantelingslengte
- klauw- en schroefbevestiging
- klemcapaciteit: 2 x 2,5 mm<sup>2</sup>/klem

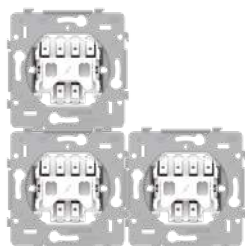

#### Perfecte koppeling

- verticaal, centerafstand 71 mm: plooizones onderaan om volgende brug tegen te plaatsen
- horizontaal: omhoog geplooide zwaluwstaarten voor een perfecte positionering

#### Niko kwaliteit

- muurvaste, onbreekbare en onscheurbare metalen sokkel

D.1

D.2

D.3

D.4

D.5

D.6



De meest recente informatie  
vind je op [www.niko.eu](http://www.niko.eu)



### **Geringe inbouwdiepte**

- meer ruimte voor de aansluiting in de inbouwdoos
- schakelaar: 18 mm
- wandcontactdoos: 21 of 28,5 mm



### **Ledverlichtingselement met automatische aansluiting**

Direct contact door eenvoudig kliksysteem

### **Snelle en eenvoudige montage**

- 3 montagestappen
- in de hoogte verstelbare afdekplaat

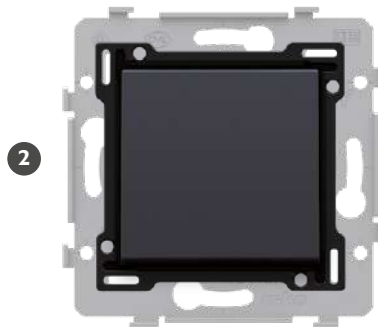
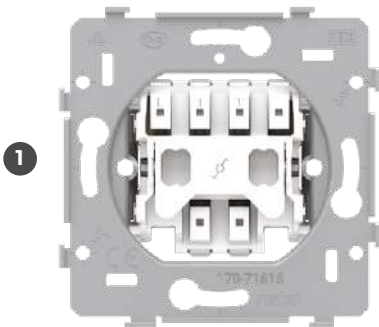

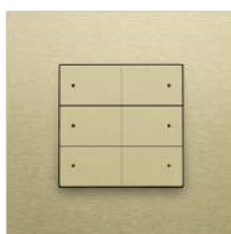

## NIEUW

### Digital black

- combineer tot 12 bedieningen op een compact en intuïtief bedieningsscherm met gebruiksvriendelijke interface
- het scherm is even groot als een Niko functie met afdekkader en past er perfect bij qua design
- je klant configureert zelf welke acties hij wil bedienen en hoe hij ze ordent
- een naderingssensor doet Digital black snel ontwaken, zo voert je klant in één handeling een actie uit

### Geconnecteerde schakelbare wandcontactdoos

- vervang eenvoudig een gewone wandcontactdoos
- schakel je wandcontactdoos in en uit met de ingebouwde schakelaar
- extra functionaliteiten in combinatie met de draadloze slimme hub: energiemeting, bediening met de smartphone, schakel automatisch aan of uit met tijdschema's of o.b.v. in te stellen verbruiksdrempels

### Niko schakelmateriaal met insteekklemmen

- klemvast dankzij de insteekklem van hoogstaande kwaliteit
- ontgrendeling vooraan: de bedrading kan de geleiders niet losduwen
- lange levensduur dankzij het doordachte productdesign
- compatibel met alle Niko afwerkingen

### Smart USB-A/C-lader

- laadt twee mobiele toestellen tegelijk, zonder adapter
- hoge uitgangsstroom: max. 3,5 A
- voorzien van USB-A- en USB-C-poort
- USB-C-poort: geen polarisatie voor de stekker
- dynamic device recognition: de lader herkent je mobiele toestel en laadt het aan de meest optimale snelheid op

### Elke afwerking in elke kleur

- elke afwerkingsset beschikbaar in alle kleuren
- nieuw: steel grey coated, gold coated en Bakelite®-look piano black coated

### Witte ledverlichtingselementen

- voor automatische aansluiting en draadaansluiting
- voor wandcontactdozen met spanningsaanduiding
- voor 12V-, 24V- en 230V-schakelaars en drukknoppen

D.1

D.2

D.3

D.4

D.5

D.6







Het aanbod van Niko is voortdurend in evolutie. Wil je weten of een bepaalde functie beschikbaar is in Niko Pure, Niko Intense of Niko Original? Neem een kijkje op [www.niko.eu](http://www.niko.eu) en ontdek er de mogelijkheden, kleuren en materialen.



Niko Original white



Niko Original light grey

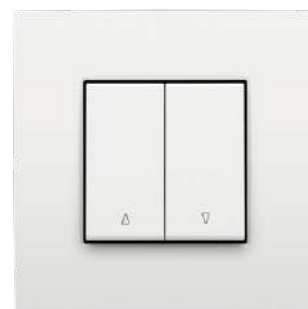

Niko Intense white



Niko Intense anthracite



Niko Pure alu steel grey



Niko Pure bamboe

D.1

D.2

D.3

D.4

D.5

D.6



## Een keuze maken?

Help je klanten een Niko afwerking kiezen. Download de Switch Niko app in de App Store of Google Play. De app zet een contrastafbeelding om in een levensechte 3D-animatie van een afwerking met de muur in hun woning als achtergrond. Een nieuwe kleur? Een ander materiaal? Die zijn snel gekozen. Zo zien ze meteen welke afwerkingen het beste in hun interieur passen. Je vindt de contrastafbeelding op: [www.niko.eu/switch-niko-app](http://www.niko.eu/switch-niko-app).



De meest recente informatie vind je op [www.niko.eu](http://www.niko.eu)



**NIEUW**

**Geconnecteerde schakelbare wandcontactdoos voor Niko Home Control met randaarde en kinderveiligheid, Zigbee®**

Met deze geconnecteerde schakelbare wandcontactdoos met ingebouwde verbruiksmeting kies je voor extra comfort, veiligheid en energiebewustzijn. De wandcontactdoos kan eenvoudig geïnstalleerd worden in alle nieuwbouwprojecten en kan ook in renovatieprojecten zonder aanpassing van de bedrading probleemloos een bestaande wandcontactdoos vervangen.

Je verbindt de wandcontactdoos zonder bijkomende bekabeling met een draadloze schakelaar en de draadloze slimme hub (552-00001) voor Niko Home Control. Zo krijg je de volledige controle over je wandcontactdozen en kun je handige nieuwe functionaliteiten toevoegen zoals:

- alles-uit- of alles-aanfunctie
  - automatische kalenderfuncties
  - afstandsbediening
  - verbruiksmeldingen
  - overzicht van je energieverbruik.
- inbouwdiepte: 35,7 mm
  - aansluiting: insteekklemmen (3 x 2 x 2,5 mm<sup>2</sup>) met ontgrendeling
  - geschikt voor standaardinbouwdozen (min. inbouwdiepte 50 mm)
  - ingangsspanning: 230 Vac ± 10 %, 50 Hz
  - sluimerverbruik: 0,25 W
  - omgevingstemperatuur: 0 - 40 °C
  - beschermingsgraad: IP2X-D
  - markering: CE-gemarkeerd
  - keurmerk: KEMA
  - maximale belasting: 16 A / 3680 W
  - interne overstrombeveiliging: schakelt uit bij > 16 A
  - interne overtemperatuurbeveiliging
  - communicatieprotocol: Zigbee® 3.0, 2,4 GHz
  - knopje op het apparaat om de fase (L) lokaal aan- en uit te schakelen
  - ledindicator voor status en foutinformatie
  - meetnauwkeurigheid: ± 0,5 W (1 - 5W), ± 5 % (5 - 3680 W) Dit apparaat mag niet worden gebruikt voor facturatie doeleinden. De gegevens die door dit apparaat zijn vastgelegd, mogen alleen voor informatiedoeleinden worden gebruikt.
  - maximum per Niko Home Control installatie: 25
  - Niet geschikt voor opladers van elektrische voertuigen (in modus 1 of 2) of zware inductieve belastingen (motoren).

**Beschikbaar in 2021\***

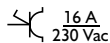

**SOKKEL**



**NIEUW**

**170-34605**

Stuks: 1

Met insteekklemmen, voor schroefbevestiging

**AFWERKINGSSET**



|  |                  |           |
|--|------------------|-----------|
|  | <b>100-66930</b> | Stuks: 10 |
|  | <b>104-66930</b> | Stuks: 10 |
|  | <b>122-66930</b> | Stuks: 10 |
|  | <b>154-66930</b> | Stuks: 10 |
|  | <b>200-66930</b> | Stuks: 10 |

|  |                  |           |
|--|------------------|-----------|
|  | <b>101-66930</b> | Stuks: 10 |
|  | <b>111-66930</b> | Stuks: 10 |
|  | <b>123-66930</b> | Stuks: 10 |
|  | <b>157-66930</b> | Stuks: 10 |
|  | <b>220-66930</b> | Stuks: 10 |

|  |                  |           |
|--|------------------|-----------|
|  | <b>102-66930</b> | Stuks: 10 |
|  | <b>121-66930</b> | Stuks: 10 |
|  | <b>124-66930</b> | Stuks: 10 |
|  | <b>161-66930</b> | Stuks: 10 |
|  | <b>221-66930</b> | Stuks: 10 |



Afdekplaten afzonderlijk te bestellen.  
Afbecldingen afgewerkte producten louter ter illustratie.

\* Aangezien dit product nog in de ontwikkelingsfase zit, kunnen de technische specificaties nog wijzigen. De technische documentatie die nu nog ontbreekt, zal aan de productpagina op onze website toegevoegd worden van zodra ze beschikbaar is.

**Wandcontactdoos zonder aarding en met kinderveiligheid**

Bij het volledige apparaat is de afwerkingsset al vastgeschroefd op de sokkel, wat zorgt voor een snelle montage.

Een volledig apparaat bestaat altijd uit een sokkel, afwerkingsset en afdekplaat.

- halogeenvrij
- inbouwdiepte: 21 mm
- slagvastheid: IK06
- beschermingsgraad: IP41
- centerafstand: 71 mm

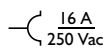













**SOKKEL**

**170-31400** Stuks: 10 Met insteekklemmen, voor schroefbevestiging



**170-31200** Stuks: 10 Met schroefklemmen, voor schroefbevestiging

**AFWERKINGSSET**

|   |                  |           |   |                  |           |   |                  |           |
|---|------------------|-----------|---|------------------|-----------|---|------------------|-----------|
|  | <b>100-66501</b> | Stuks: 20 |  | <b>101-66501</b> | Stuks: 20 |  | <b>102-66501</b> | Stuks: 20 |
|  | <b>104-66501</b> | Stuks: 20 |  | <b>121-66501</b> | Stuks: 10 |  | <b>122-66501</b> | Stuks: 10 |
|  | <b>123-66501</b> | Stuks: 10 |  | <b>124-66501</b> | Stuks: 10 |  | <b>154-66501</b> | Stuks: 10 |
|  | <b>157-66501</b> | Stuks: 10 |  | <b>161-66501</b> | Stuks: 10 |  | <b>200-66501</b> | Stuks: 10 |
|  | <b>220-66501</b> | Stuks: 10 |  | <b>221-66501</b> | Stuks: 10 |   |                  |           |

**VOLLEDIG APPARAAT MET INSTEEKKLEMMEN EN VASTGESCHROEFDE AFWERKINGSSET, VOOR SCHROEFBEVESTIGING**

|   |                  |           |   |                  |           |
|---|------------------|-----------|---|------------------|-----------|
|  | <b>100-66515</b> | Stuks: 10 |  | <b>101-66515</b> | Stuks: 10 |
|---|------------------|-----------|---|------------------|-----------|

D.1

D.2

D.3

D.4

D.5

D.6



Afdekplaten afzonderlijk te bestellen.  
Afbeeldingen afgewerkte producten louter ter illustratie.



De meest recente informatie  
vind je op [www.niko.eu](http://www.niko.eu)



**Wandcontactdoos met randaarde en kinderveiligheid**

Bij het volledige apparaat is de afwerkingsset al vastgeschroefd op de sokkel, wat zorgt voor een snelle montage.

Een volledig apparaat bestaat altijd uit een sokkel, afwerkingsset en afdekplaat.

- halogeenvrij
- inbouwdiepte: 28,5 mm
- slagvastheid: IK06
- beschermingsgraad: IP41
- centerafstand: 71 mm

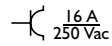

**SOKKEL**



**170-34400** Stuks: 10 Met insteekklemmen, voor schroefbevestiging



**170-34200** Stuks: 10 Met schroefklemmen, voor schroefbevestiging

**AFWERKINGSSET**



|  |                  |           |  |                  |           |  |                  |           |
|--|------------------|-----------|--|------------------|-----------|--|------------------|-----------|
|  | <b>100-66901</b> | Stuks: 20 |  | <b>101-66901</b> | Stuks: 20 |  | <b>111-66901</b> | Stuks: 20 |
|  | <b>102-66901</b> | Stuks: 20 |  | <b>104-66901</b> | Stuks: 20 |  | <b>121-66901</b> | Stuks: 10 |
|  | <b>122-66901</b> | Stuks: 10 |  | <b>123-66901</b> | Stuks: 10 |  | <b>124-66901</b> | Stuks: 10 |
|  | <b>154-66901</b> | Stuks: 10 |  | <b>157-66901</b> | Stuks: 10 |  | <b>161-66901</b> | Stuks: 10 |
|  | <b>200-66901</b> | Stuks: 10 |  | <b>220-66901</b> | Stuks: 10 |  | <b>221-66901</b> | Stuks: 10 |

**VOLLEDIG APPARAAT MET INSTEKKLEMMEN EN VASTGESCHROEFDE AFWERKINGSSET, VOOR SCHROEFBEVESTIGING**



|  |                  |           |  |                  |           |  |                  |           |
|--|------------------|-----------|--|------------------|-----------|--|------------------|-----------|
|  | <b>100-66915</b> | Stuks: 10 |  | <b>101-66915</b> | Stuks: 10 |  | <b>111-66915</b> | Stuks: 10 |
|--|------------------|-----------|--|------------------|-----------|--|------------------|-----------|



Afdekplaten afzonderlijk te bestellen.  
Afbeldingen afgewerkte producten louter ter illustratie.

**Wandcontactdoos met randaarde, kinderveiligheid en spanningsaanduiding**

- centerafstand: 71 mm
- inbouwdiepte: 34 mm

**SOKKEL**

**170-34400** Stuks: 10 Met insteekklemmen, voor schroefbevestiging



**170-34200** Stuks: 10 Met schroefklemmen, voor schroefbevestiging

**AFWERKINGSSET MET TRANSPARENT VENSTERTJE**

|  |                  |           |  |                  |           |  |                  |           |
|--|------------------|-----------|--|------------------|-----------|--|------------------|-----------|
|  | <b>100-66908</b> | Stuks: 20 |  | <b>101-66908</b> | Stuks: 20 |  | <b>102-66908</b> | Stuks: 20 |
|  | <b>104-66908</b> | Stuks: 20 |  | <b>121-66908</b> | Stuks: 10 |  | <b>122-66908</b> | Stuks: 10 |
|  | <b>123-66908</b> | Stuks: 10 |  | <b>124-66908</b> | Stuks: 10 |  | <b>154-66908</b> | Stuks: 10 |
|  | <b>157-66908</b> | Stuks: 10 |  | <b>161-66908</b> | Stuks: 10 |  | <b>200-66908</b> | Stuks: 10 |
|  | <b>220-66908</b> | Stuks: 10 |  | <b>221-66908</b> | Stuks: 10 |  |                  |           |

**ACCESSOIRES VOOR SPANNINGSAANDUIDING**

**170-37096** Stuks: 10 Ledverlichtingselement, amberkleurig



**170-37097** Stuks: 10 Ledverlichtingselement, groen



**170-37098** Stuks: 10 Ledverlichtingselement, rood



**170-37099** Stuks: 10 Ledverlichtingselement, blauw



**NIEUW** **170-37100** Stuks: 10 Ledverlichtingselement, wit

D.1

D.2

D.3

D.4

D.5

D.6



Afdekplaten afzonderlijk te bestellen.  
Afbeeldingen afgewerkte producten louter ter illustratie.



De meest recente informatie  
vind je op [www.niko.eu](http://www.niko.eu)



### Wandcontactdoos met randaarde, kinderveiligheid en overspanningsbeveiliging

Deze wandcontactdoos wordt gebruikt om gevoelige elektronische apparatuur (zoals tv, hifi, pc, was- en vaatwasmachines en medische apparatuur) te beveiligen tegen spanningspieken op het net als gevolg van netstoringen of indirecte blikseminslag. Het biedt geen beveiliging tegen spanningspieken die de apparatuur binnendringen via andere wegen (zoals kabel distributie, datalijnen en telefoonlijnen). De wandcontactdoos beveiligt uitsluitend het aangesloten toestel binnen de onderstaande technische specificaties. Het product draagt het CEBEC-keurmerk conform de normen IEC61643-1 en EN61643-11 (klasse III, type 3). De varistoren die de spanning beperken tussen fase (L) en nulgeleider (N), zijn thermisch gecontroleerd. Als de rode led brandt, werkt de beveiliging niet meer (het beveiligde toestel blijft wel onder spanning) en moet de overspanningsmodule worden vervangen.

- centerafstand: 71 mm
- nominale spanning: 250 Vac
- nominale stroom: 16 A
- overspanningsbegrenzing (Up) (L-L/L-PE): 1,5 kV
- maximale piekspanning (Uoc): 4 kV
- inbouwdiepte: 38,5 mm
- geschikt voor inbouwdozen met een inbouwdiepte van 50 mm
- kortsluitstroom (Icc): 1,5 kA
- omgevingstemperatuur: -5 - 40 °C

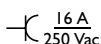

#### SOKKEL



**170-34400** Stuks: 10 Met insteekklemmen, voor schroefbevestiging



**170-34200** Stuks: 10 Met schroefklemmen, voor schroefbevestiging

#### AFWERKINGSSET MET TRANSPARANT VENSTERTJE EN SYMBOOL



|  |                  |           |  |                  |           |  |                  |           |
|--|------------------|-----------|--|------------------|-----------|--|------------------|-----------|
|  | <b>100-66906</b> | Stuks: 20 |  | <b>101-66906</b> | Stuks: 20 |  | <b>102-66906</b> | Stuks: 20 |
|  | <b>104-66906</b> | Stuks: 20 |  | <b>121-66906</b> | Stuks: 10 |  | <b>122-66906</b> | Stuks: 10 |
|  | <b>123-66906</b> | Stuks: 10 |  | <b>124-66906</b> | Stuks: 10 |  | <b>154-66906</b> | Stuks: 10 |
|  | <b>157-66906</b> | Stuks: 10 |  | <b>161-66906</b> | Stuks: 10 |  | <b>200-66906</b> | Stuks: 10 |
|  | <b>220-66906</b> | Stuks: 10 |  | <b>221-66906</b> | Stuks: 10 |  |                  |           |

#### OVERSPANNINGSMODULE



**170-37095** Stuks: 10 Met rode led



**Wandcontactdoos met penaarde en kinderveiligheid**

Belgisch aardingsstelsel voor bijzondere installaties.

Een volledig apparaat bestaat altijd uit een sokkel, afwerkingsset en afdekplaat.

- halogeenvrij
- inbouwdiepte: 28,5 mm
- slagvastheid: IK06
- beschermingsgraad: IP41
- centerafstand: 71 mm

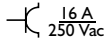
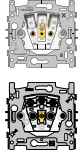
**SOKKEL**

|              |                  |           |                               |
|--------------|------------------|-----------|-------------------------------|
| <b>NIEUW</b> | <b>170-33105</b> | Stuks: 10 | Met insteekklemmen en klauwen |
|              | <b>170-33100</b> | Stuks: 10 | Met schroefklemmen en klauwen |

**AFWERKINGSSET**

|  |                  |           |  |                  |           |  |                  |           |
|--|------------------|-----------|--|------------------|-----------|--|------------------|-----------|
|  | <b>100-66601</b> | Stuks: 20 |  | <b>101-66601</b> | Stuks: 20 |  | <b>102-66601</b> | Stuks: 20 |
|  | <b>104-66601</b> | Stuks: 20 |  | <b>121-66601</b> | Stuks: 10 |  | <b>122-66601</b> | Stuks: 10 |
|  | <b>123-66601</b> | Stuks: 10 |  | <b>124-66601</b> | Stuks: 10 |  | <b>154-66601</b> | Stuks: 10 |
|  | <b>157-66601</b> | Stuks: 10 |  | <b>161-66601</b> | Stuks: 10 |  | <b>200-66601</b> | Stuks: 10 |
|  | <b>220-66601</b> | Stuks: 10 |  | <b>221-66601</b> | Stuks: 10 |  |                  |           |

**VOLLEDIG APPARAAT MET INSTEKKLEMMEN EN KLAUWEN**

|  |                  |           |  |                  |           |
|--|------------------|-----------|--|------------------|-----------|
|  | <b>100-66605</b> | Stuks: 10 |  | <b>101-66605</b> | Stuks: 10 |
|--|------------------|-----------|--|------------------|-----------|

**VOLLEDIG APPARAAT MET SCHROEFKLEMMEN EN KLAUWEN**

|  |                  |           |
|--|------------------|-----------|
|  | <b>100-66600</b> | Stuks: 10 |
|--|------------------|-----------|

**Gekleurde wandcontactdoos met randaarde en kinderveiligheid**

Voor noodstroomvoorziening (bv. in ziekenhuizen):

- groen voor bijvoorbeeld algemene voeding,
- oranje voor bijvoorbeeld de voeding van no-breaknetwerken,
- rood voor bijvoorbeeld de voeding van datanetwerken.

De sokkel en de afwerkingsset zijn in dezelfde kleur.

- centerafstand: 71 mm • inbouwdiepte: 28,5 mm

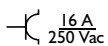
**VOLLEDIG APPARAAT MET INSTEKKLEMMEN, VOOR SCHROEFBEVESTIGING**

|  |                  |           |  |                  |           |  |                  |           |
|--|------------------|-----------|--|------------------|-----------|--|------------------|-----------|
|  | <b>197-66915</b> | Stuks: 10 |  | <b>198-66915</b> | Stuks: 10 |  | <b>199-66915</b> | Stuks: 10 |
|--|------------------|-----------|--|------------------|-----------|--|------------------|-----------|



Afdekplaten afzonderlijk te bestellen.  
Afbeeldingen afgewerkte producten louter ter illustratie.



De meest recente informatie  
vind je op [www.niko.eu](http://www.niko.eu)



**Wandcontactdoos met twee equipotentiaalcontacten**

- centerafstand: 20 mm
- 1 x 6 mm<sup>2</sup> en 4 x 2,5 mm<sup>2</sup>



**SOKKEL**



**170-09510** Stuks: 10 Met schroefklemmen, voor schroefbevestiging

**AFWERKINGSSET**



**100-69512** Stuks: 10 **101-69512** Stuks: 10

**ACCESSOIRES**



**170-39513** Stuks: 10 Haakse stekkerbus voor extra soepele kabel



**Dubbele wandcontactdoos met randaarde en kinderveiligheid, voorbedraad, horizontaal**

Voor montage in een tweevoudige inbouwdoos zonder tussenwand. De verbinding tussen de twee sokkels is al voorzien. Dankzij de aangepaste montagegaten kan het mechanisme perfect horizontaal worden geïnstalleerd, ook wanneer de inbouwdoos niet waterpas gemonteerd is.

Bij het volledige apparaat is de afwerkingsset al vastgeschroefd op de sokkel, wat zorgt voor een snelle montage.

Een volledig apparaat bestaat altijd uit een sokkel, afwerkingsset en afdekplaat.

- halogeenvrij
- inbouwdiepte: 28,5 mm
- slagvastheid: IK06
- beschermingsgraad: IP41
- centerafstand: 71 mm



**SOKKEL**

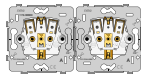

**170-38800** Stuks: 5 Met insteekklemmen, voor schroefbevestiging

**AFWERKINGSSET**



|                  |           |                  |           |                  |           |
|------------------|-----------|------------------|-----------|------------------|-----------|
| <b>100-66901</b> | Stuks: 20 | <b>101-66901</b> | Stuks: 20 | <b>111-66901</b> | Stuks: 20 |
| <b>102-66901</b> | Stuks: 20 | <b>104-66901</b> | Stuks: 20 | <b>121-66901</b> | Stuks: 10 |
| <b>122-66901</b> | Stuks: 10 | <b>123-66901</b> | Stuks: 10 | <b>124-66901</b> | Stuks: 10 |
| <b>154-66901</b> | Stuks: 10 | <b>157-66901</b> | Stuks: 10 | <b>161-66901</b> | Stuks: 10 |
| <b>200-66901</b> | Stuks: 10 | <b>220-66901</b> | Stuks: 10 | <b>221-66901</b> | Stuks: 10 |

**VOLLEDIG APPARAAT MET INSTEKKLEMMEN, VASTGESCHROEFDE AFWERKINGSSET EN AFDEKPLAAT, VOOR SCHROEFBEVESTIGING**

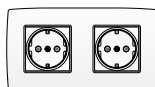

**100-67940** Stuks: 5 **101-67940** Stuks: 5 **111-67940** Stuks: 5



Afdekplaten afzonderlijk te bestellen.  
Afbeeldingen afgewerkte producten louter ter illustratie.



**Dubbele wandcontactdoos met randaarde, kinderveiligheid, ultravlak, verticaal**

Inclusief afdekplaat met geïntegreerde centraalplaat. De opbouwhoogte bedraagt 8 mm. Deze wandcontactdoos kan worden ingebouwd in een speciale ovale enkelvoudige inbouwdoos.

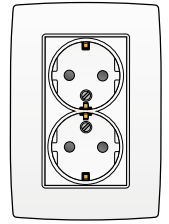
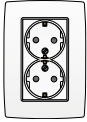
 $\frac{16 A}{250 V_{ac}}$ 
**VOLLEDIG APPARAAT MET INSTEKKLEMMEN, VOOR SCHROEFBEVESTIGING**

100-67835

Stuks: 10

101-67835

Stuks: 10

111-67835

Stuks: 10

**Dubbele wandcontactdoos met randaarde en kinderveiligheid, verticaal**

Inclusief afdekplaat met geïntegreerde centraalplaat. Voor halfopbouw. De opbouwhoogte bedraagt 23 mm. Voor montage in een enkelvoudige inbouwdoos.

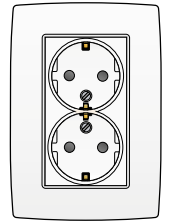
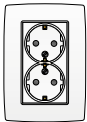
 $\frac{16 A}{250 V_{ac}}$ 
**VOLLEDIG APPARAAT MET INSTEKKLEMMEN, VOOR SCHROEFBEVESTIGING**

100-67845

Stuks: 10

101-67845

Stuks: 10

**Dubbele wandcontactdoos zonder aarding, verticaal**

Voor montage in een enkelvoudige inbouwdoos.

Opgelet: Zonder kinderveiligheid.

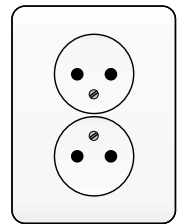
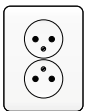
 $\frac{16 A}{250 V_{ac}}$ 
**VOLLEDIG APPARAAT MET SCHROEFKLEMMEN, VOOR SCHROEFBEVESTIGING**

100-67410

Stuks: 10

101-67410

Stuks: 10

**Combinatie van wisselchakelaar en wandcontactdoos zonder aarding**

Voor montage in een enkelvoudige inbouwdoos.

Opgelet: Zonder kinderveiligheid.

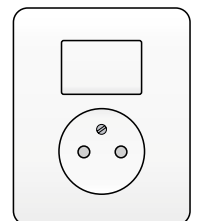
 $\frac{10 A 250 V_{ac}}{16 A 250 V_{ac}}$ 
**VOLLEDIG APPARAAT MET SCHROEFKLEMMEN, VOOR SCHROEFBEVESTIGING**

100-62416

Stuks: 10

101-62416

Stuks: 10



Afdekplaten afzonderlijk te bestellen.  
Afbeeldingen afgewerkte producten louter ter illustratie.



De meest recente informatie  
vind je op [www.niko.eu](http://www.niko.eu)

D.1

D.2

D.3

D.4

D.5

D.6

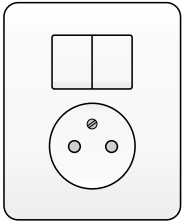

### Combinatie van serieschakelaar en wandcontactdoos zonder aarding

Voor montage in een enkelvoudige inbouwdoos.

Opgelet: Zonder kinderveiligheid.

10 A 250 Vac  
16 A  
250 Vac

**VOLLEDIG APPARAAT MET SCHROEFKLEMMEN, VOOR SCHROEFBEVESTIGING**

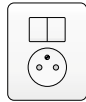

**100-62415** Stuks: 10

**101-62415** Stuks: 10

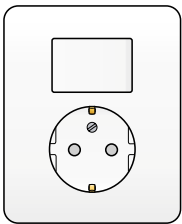

### Combinatie van wisselschakelaar en wandcontactdoos met randaarde

Voor montage in een enkelvoudige inbouwdoos.

Opgelet: Zonder kinderveiligheid.

10 A 250 Vac  
16 A  
250 Vac

**VOLLEDIG APPARAAT MET SCHROEFKLEMMEN, VOOR SCHROEFBEVESTIGING**

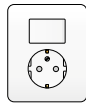

**100-62816** Stuks: 5

**101-62816** Stuks: 5

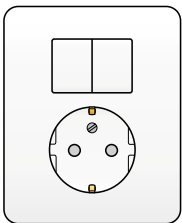

### Combinatie van serieschakelaar en wandcontactdoos met randaarde

Voor montage in een enkelvoudige inbouwdoos.

Opgelet: Zonder kinderveiligheid.

10 A 250 Vac  
16 A  
250 Vac

**VOLLEDIG APPARAAT MET SCHROEFKLEMMEN, VOOR SCHROEFBEVESTIGING**

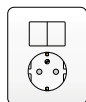

**100-62815** Stuks: 5

**101-62815** Stuks: 5



Afdekplaten afzonderlijk te bestellen.  
Afbeeldingen afgewerkte producten louter ter illustratie.

### Dubbele smart USB-A en USB-C-lader van 3,5 A

Deze smart USB-lader laadt één of twee mobiele toestellen op zoals mobiele telefoons, tablets, foto toestellen, mp3 spelers en navigatieapparaten. De toestellen moeten geschikt zijn om via een USB-A of USB-C-poort opgeladen te worden.

De "smart"-functionaliteit zorgt ervoor dat het mobiele toestel op de snelste manier wordt opgeladen (dynamic device recognition)

- montage: inbouwdoos met inbouwdiepte van minimaal 50 mm
- voedingsspanning: 100 - 230 Vac  $\pm$  10 %, 50 - 60 Hz
- maximaal stroomverbruik: 200 mA (230 Vac)
- stand-byverbruik: < 100 mW (230 Vac)
- uitgangsspanning: 5 Vdc  $\pm$  5%
- 2 USB-aansluitingen 3.0: type A en type C
- maximale uitgangsstroom: 3500 mA bij Ta 35 °C
- aansluitklemmen: 2 (maximale capaciteit per schroefklem: 2 x 2,5 mm<sup>2</sup>)
- overspanningscategorie III
- laadgedrag volgens IEC62694
- CE-gemarkeerd
- USB C ready mits gebruik van de correcte kabel
- dynamic device recognition



NIEUW



NIEUW

420-00513

Stuks: 6

Met schroefklemmen, voor schroefbevestiging

#### AFWERKINGSSET



|  |                  |           |  |                  |           |  |                  |           |
|--|------------------|-----------|--|------------------|-----------|--|------------------|-----------|
|  | <b>100-68002</b> | Stuks: 10 |  | <b>101-68002</b> | Stuks: 10 |  | <b>102-68002</b> | Stuks: 10 |
|  | <b>104-68002</b> | Stuks: 10 |  | <b>121-68002</b> | Stuks: 10 |  | <b>122-68002</b> | Stuks: 10 |
|  | <b>123-68002</b> | Stuks: 10 |  | <b>124-68002</b> | Stuks: 10 |  | <b>154-68002</b> | Stuks: 10 |
|  | <b>157-68002</b> | Stuks: 10 |  | <b>161-68002</b> | Stuks: 10 |  | <b>200-68002</b> | Stuks: 10 |
|  | <b>220-68002</b> | Stuks: 10 |  | <b>221-68002</b> | Stuks: 10 |  |                  |           |

### Smart USB-A-lader van 3,5 A

Deze smart USB-lader laadt één of twee mobiele toestellen op zoals mobiele telefoons, tablets, foto toestellen, mp3 spelers en navigatieapparaten. De toestellen moeten geschikt zijn om via een USB-poort opgeladen te worden.

De "smart"-functionaliteit zorgt ervoor dat het mobiele toestel op de snelste manier wordt opgeladen (dynamic device recognition)

- montage: inbouwdoos met inbouwdiepte van minimaal 50 mm
- voedingsspanning: 100 - 230 Vac  $\pm$  10 %, 50 - 60 Hz
- maximaal stroomverbruik: 200 mA (230 Vac)
- stand-byverbruik: < 100 mW (230 Vac)
- uitgangsspanning: 5 Vdc  $\pm$  5%
- 2 USB-aansluitingen 3.0: type A
- maximale uitgangsstroom: 3500 mA bij Ta 35 °C
- aansluitklemmen: 2 (maximale capaciteit per schroefklem: 2 x 2,5 mm<sup>2</sup>)
- overspanningscategorie III
- laadgedrag volgens IEC62694
- CE-gemarkeerd
- USB-C ready mits gebruik van de correcte kabel
- dynamic device recognition



D.1

D.2

D.3

D.4

D.5

D.6

#### SOKKEL



420-00511

Stuks: 6

Met schroefklemmen, voor schroefbevestiging

#### AFWERKINGSSET



|  |                  |           |  |                  |           |  |                  |           |
|--|------------------|-----------|--|------------------|-----------|--|------------------|-----------|
|  | <b>100-68001</b> | Stuks: 10 |  | <b>101-68001</b> | Stuks: 10 |  | <b>102-68001</b> | Stuks: 10 |
|  | <b>104-68001</b> | Stuks: 10 |  | <b>121-68001</b> | Stuks: 10 |  | <b>122-68001</b> | Stuks: 10 |
|  | <b>123-68001</b> | Stuks: 10 |  | <b>124-68001</b> | Stuks: 10 |  | <b>154-68001</b> | Stuks: 10 |
|  | <b>157-68001</b> | Stuks: 10 |  | <b>161-68001</b> | Stuks: 10 |  | <b>200-68001</b> | Stuks: 10 |
|  | <b>220-68001</b> | Stuks: 10 |  | <b>221-68001</b> | Stuks: 10 |  |                  |           |



Afdekkapen afzonderlijk te bestellen.  
Afbeldingen afgewerkte producten louter ter illustratie.



De meest recente informatie  
vind je op [www.niko.eu](http://www.niko.eu)



NIEUW

### Digital black, geconnecteerd personaliseerbaar bedieningsscherm, 230 V

Digital black is een volledig personaliseerbaar bedieningsscherm met een uitermate gebruiksvriendelijke interface met duidelijke symbolen. Het bedieningsscherm wordt automatisch geactiveerd als je het met de hand benadert, zo kan je in één handeling je verlichting schakelen of dimmen, sferen instellen, ventilatiestand instellen, rolluiken en zonnewering in de gewenste stand brengen. Kortom, alle mogelijke bedieningstypes beschikbaar in je Niko Home Control systeem. Heb je een Niko Home Control thermostaat (550-13051)? Dan stel je met Digital black eenvoudig de temperatuur in. Met de bijhorende Niko Home app kies jij niet alleen welke bedieningen getoond worden of waar deze staan op het scherm maar ook de manier waarop je door je bedieningsschermen navigeert. Je downloadt deze app gratis in de respectievelijke app store voor je mobiele toestel.

Digital black kan eenvoudig gemonteerd worden in een standaardinbouwdoos en wordt gevoed op 230 Vac. Deze 230 Vac-variant is uitgerust met een schakelcontact van 10 A (resistief) waardoor hij eenvoudig een klassieke enkelpolige schakelaar kan vervangen. In combinatie met de draadloze slimme hub voor Niko Home Control (552-00001) en extra geconnecteerde bedieningspunten uit het Niko Home Control gamma voor klassieke bedrading, voeg je heel eenvoudig extra automatisatie toe aan je klassieke installatie.

Digital black communiceert via je draadloze thuisnetwerk met de rest van je Niko Home Control systeem. Je hebt een actieve internetverbinding nodig om Digital black te kunnen activeren. Deze internetverbinding zorgt ervoor dat Digital black en je Niko Home Control installatie steeds up-to-date zijn en over de meest recente functionaliteiten beschikt.

- voor gebruik met meerdere bedieningspunten, gebruik je NO-drukknoppen, ook bij de vervanging van een enkelpolige, wissel- of kruisschakeling
- aangewezen montagehoogte 110 – 160 cm
- voedingsspanning: 230 Vac  $\pm$  10 %, 50 Hz
- wifi: 2,4 GHz bgn
- omgevingstemperatuur: 0 – 40 °C
- naderingssensor: 0 – 30 cm
- lichtsensor voor automatische aanpassing schermintensiteit
- maximaal aantal per installatie: 10
- schermgrootte: 3,6"
- schermresolutie: 1024 x 768
- schermafmetingen: 83 x 83 x 11,5 mm (HxBxD)
- afmetingen inbouwmechanisme: 75 x 70 x 24 mm (HxBxD)
- beschermingsgraad: IP20
- CE-gemarkeerd

**Beschikbaar in het tweede kwartaal van 2020\***



#### VOLLEDIG APPARAAT

**551-18001** Stuks: 1 Met insteekklemmen voor schroefbevestiging



Afdekplaten afzonderlijk te bestellen.  
Afbeeldingen afgewerkte producten louter ter illustratie.

\* Aangezien dit product nog in de ontwikkelingsfase zit, kunnen de technische specificaties nog wijzigen. De technische documentatie die nu nog ontbreekt, zal aan de productpagina op onze website toegevoegd worden zodra ze beschikbaar is.

**Enkelpolige schakelaar**

- centerafstand: 71 mm

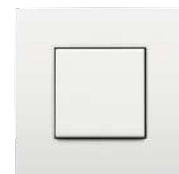

10 A  
250 Vac

**SOKKEL**

**170-71115** Stuks: 10 Met insteekklemmen, voor schroefbevestiging



**170-71101** Stuks: 10 Met schroefklemmen, voor schroefbevestiging

**AFWERKINGSSET**

|  |                  |           |  |                  |           |  |                  |           |
|--|------------------|-----------|--|------------------|-----------|--|------------------|-----------|
|  | <b>100-61105</b> | Stuks: 20 |  | <b>101-61105</b> | Stuks: 20 |  | <b>111-61105</b> | Stuks: 20 |
|  | <b>102-61105</b> | Stuks: 20 |  | <b>104-61105</b> | Stuks: 20 |  | <b>121-61105</b> | Stuks: 10 |
|  | <b>122-61105</b> | Stuks: 10 |  | <b>123-61105</b> | Stuks: 10 |  | <b>124-61105</b> | Stuks: 10 |
|  | <b>154-61105</b> | Stuks: 10 |  | <b>157-61105</b> | Stuks: 10 |  | <b>161-61105</b> | Stuks: 10 |
|  | <b>200-61105</b> | Stuks: 10 |  | <b>220-61105</b> | Stuks: 10 |  | <b>221-61105</b> | Stuks: 10 |

**AFWERKINGSSET MET TRANSPARANT TEKSTVELD**

|  |                  |           |  |                  |           |  |                  |           |
|--|------------------|-----------|--|------------------|-----------|--|------------------|-----------|
|  | <b>100-60905</b> | Stuks: 20 |  | <b>101-60905</b> | Stuks: 20 |  | <b>102-60905</b> | Stuks: 20 |
|  | <b>104-60905</b> | Stuks: 20 |  | <b>121-60905</b> | Stuks: 10 |  | <b>122-60905</b> | Stuks: 10 |
|  | <b>123-60905</b> | Stuks: 10 |  | <b>124-60905</b> | Stuks: 10 |  | <b>154-60905</b> | Stuks: 10 |
|  | <b>157-60905</b> | Stuks: 10 |  | <b>161-60905</b> | Stuks: 10 |  | <b>200-60905</b> | Stuks: 10 |
|  | <b>220-60905</b> | Stuks: 10 |  | <b>221-60905</b> | Stuks: 10 |  |                  |           |

**AFWERKINGSSET MET TRANSPARANT VENSTERTJE (ZIE ACCESSOIRES VOOR LEDVERLICHTINGSELEMENTEN)**

|  |                  |           |  |                  |           |  |                  |           |
|--|------------------|-----------|--|------------------|-----------|--|------------------|-----------|
|  | <b>100-60005</b> | Stuks: 20 |  | <b>101-60005</b> | Stuks: 20 |  | <b>102-60005</b> | Stuks: 20 |
|  | <b>104-60005</b> | Stuks: 20 |  | <b>121-60005</b> | Stuks: 10 |  | <b>122-60005</b> | Stuks: 10 |
|  | <b>123-60005</b> | Stuks: 10 |  | <b>124-60005</b> | Stuks: 10 |  | <b>154-60005</b> | Stuks: 10 |
|  | <b>157-60005</b> | Stuks: 10 |  | <b>161-60005</b> | Stuks: 10 |  | <b>200-60005</b> | Stuks: 10 |
|  | <b>220-60005</b> | Stuks: 10 |  | <b>221-60005</b> | Stuks: 10 |  |                  |           |

D.1

D.2

D.3

D.4

D.5

D.6



Afdeklatten afzonderlijk te bestellen.  
Afbeeldingen afgewerkte producten louter ter illustratie.



De meest recente informatie  
vind je op [www.niko.eu](http://www.niko.eu)

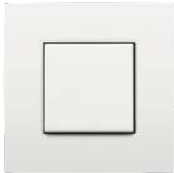

**Tweepolige schakelaar**

- centerafstand: 71 mm



**SOKKEL**



**170-71215** Stuks: 10 Met insteekklemmen, voor schroefbevestiging



**170-71201** Stuks: 10 Met schroefklemmen, voor schroefbevestiging

**AFWERKINGSSET**



|  |                  |           |  |                  |           |  |                  |           |
|--|------------------|-----------|--|------------------|-----------|--|------------------|-----------|
|  | <b>100-61105</b> | Stuks: 20 |  | <b>101-61105</b> | Stuks: 20 |  | <b>111-61105</b> | Stuks: 20 |
|  | <b>102-61105</b> | Stuks: 20 |  | <b>104-61105</b> | Stuks: 20 |  | <b>121-61105</b> | Stuks: 10 |
|  | <b>122-61105</b> | Stuks: 10 |  | <b>123-61105</b> | Stuks: 10 |  | <b>124-61105</b> | Stuks: 10 |
|  | <b>154-61105</b> | Stuks: 10 |  | <b>157-61105</b> | Stuks: 10 |  | <b>161-61105</b> | Stuks: 10 |
|  | <b>200-61105</b> | Stuks: 10 |  | <b>220-61105</b> | Stuks: 10 |  | <b>221-61105</b> | Stuks: 10 |

**AFWERKINGSSET MET TRANSPARANT TEKSTVELD**



|  |                  |           |  |                  |           |  |                  |           |
|--|------------------|-----------|--|------------------|-----------|--|------------------|-----------|
|  | <b>100-60905</b> | Stuks: 20 |  | <b>101-60905</b> | Stuks: 20 |  | <b>102-60905</b> | Stuks: 10 |
|  | <b>104-60905</b> | Stuks: 20 |  | <b>121-60905</b> | Stuks: 10 |  | <b>122-60905</b> | Stuks: 10 |
|  | <b>123-60905</b> | Stuks: 10 |  | <b>124-60905</b> | Stuks: 10 |  | <b>154-60905</b> | Stuks: 10 |
|  | <b>157-60905</b> | Stuks: 10 |  | <b>161-60905</b> | Stuks: 10 |  | <b>200-60905</b> | Stuks: 10 |
|  | <b>220-60905</b> | Stuks: 10 |  | <b>221-60905</b> | Stuks: 10 |  |                  |           |

**AFWERKINGSSET MET TRANSPARANT VENSTERTJE (ZIE ACCESSOIRES VOOR LEDVERLICHTINGSELEMENTEN)**



|  |                  |           |  |                  |           |  |                  |           |
|--|------------------|-----------|--|------------------|-----------|--|------------------|-----------|
|  | <b>100-60005</b> | Stuks: 20 |  | <b>101-60005</b> | Stuks: 20 |  | <b>102-60005</b> | Stuks: 10 |
|  | <b>104-60005</b> | Stuks: 20 |  | <b>121-60005</b> | Stuks: 10 |  | <b>122-60005</b> | Stuks: 10 |
|  | <b>123-60005</b> | Stuks: 10 |  | <b>124-60005</b> | Stuks: 10 |  | <b>154-60005</b> | Stuks: 10 |
|  | <b>157-60005</b> | Stuks: 10 |  | <b>161-60005</b> | Stuks: 10 |  | <b>200-60005</b> | Stuks: 10 |
|  | <b>220-60005</b> | Stuks: 10 |  | <b>221-60005</b> | Stuks: 10 |  |                  |           |



Afdeklatten afzonderlijk te bestellen.  
Afbeeldingen afgewerkte producten louter ter illustratie.

**Tweepolige schakelaar, 16 A**

- centerafstand: 71 mm

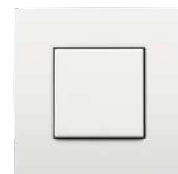

16 A  
250 Vac

**SOKKEL**

**170-71315** Stuks: 10 Met insteekklemmen, voor schroefbevestiging



**170-71301** Stuks: 10 Met schroefklemmen, voor schroefbevestiging

**AFWERKINGSSET**

|  |                  |           |  |                  |           |  |                  |           |
|--|------------------|-----------|--|------------------|-----------|--|------------------|-----------|
|  | <b>100-61105</b> | Stuks: 20 |  | <b>101-61105</b> | Stuks: 20 |  | <b>111-61105</b> | Stuks: 20 |
|  | <b>102-61105</b> | Stuks: 20 |  | <b>104-61105</b> | Stuks: 20 |  | <b>121-61105</b> | Stuks: 10 |
|  | <b>122-61105</b> | Stuks: 10 |  | <b>123-61105</b> | Stuks: 10 |  | <b>124-61105</b> | Stuks: 10 |
|  | <b>154-61105</b> | Stuks: 10 |  | <b>157-61105</b> | Stuks: 10 |  | <b>161-61105</b> | Stuks: 10 |
|  | <b>200-61105</b> | Stuks: 10 |  | <b>220-61105</b> | Stuks: 10 |  | <b>221-61105</b> | Stuks: 10 |

**AFWERKINGSSET MET TRANSPARANT TEKSTVELD**

|  |                  |           |  |                  |           |  |                  |           |
|--|------------------|-----------|--|------------------|-----------|--|------------------|-----------|
|  | <b>100-60905</b> | Stuks: 20 |  | <b>101-60905</b> | Stuks: 20 |  | <b>102-60905</b> | Stuks: 20 |
|  | <b>104-60905</b> | Stuks: 20 |  | <b>121-60905</b> | Stuks: 10 |  | <b>122-60905</b> | Stuks: 10 |
|  | <b>123-60905</b> | Stuks: 10 |  | <b>124-60905</b> | Stuks: 10 |  | <b>154-60905</b> | Stuks: 10 |
|  | <b>157-60905</b> | Stuks: 10 |  | <b>161-60905</b> | Stuks: 10 |  | <b>200-60905</b> | Stuks: 10 |
|  | <b>220-60905</b> | Stuks: 10 |  | <b>221-60905</b> | Stuks: 10 |  |                  |           |

**AFWERKINGSSET MET TRANSPARANT VENSTERTJE (ZIE ACCESSOIRES VOOR LEDVERLICHTINGSELEMENTEN)**

|  |                  |           |  |                  |           |  |                  |           |
|--|------------------|-----------|--|------------------|-----------|--|------------------|-----------|
|  | <b>100-60005</b> | Stuks: 20 |  | <b>101-60005</b> | Stuks: 20 |  | <b>102-60005</b> | Stuks: 20 |
|  | <b>104-60005</b> | Stuks: 20 |  | <b>121-60005</b> | Stuks: 10 |  | <b>122-60005</b> | Stuks: 10 |
|  | <b>123-60005</b> | Stuks: 10 |  | <b>124-60005</b> | Stuks: 10 |  | <b>154-60005</b> | Stuks: 10 |
|  | <b>157-60005</b> | Stuks: 10 |  | <b>161-60005</b> | Stuks: 10 |  | <b>200-60005</b> | Stuks: 10 |
|  | <b>220-60005</b> | Stuks: 10 |  | <b>221-60005</b> | Stuks: 10 |  |                  |           |

D.1

D.2

D.3

D.4

D.5

D.6



Afdeklatten afzonderlijk te bestellen.  
Afbeeldingen afgewerkte producten louter ter illustratie.



De meest recente informatie  
vind je op [www.niko.eu](http://www.niko.eu)



**Wisselschakelaar**

- centerafstand: 71 mm



**SOKKEL**



**170-71615** Stuks: 10 Met insteekklemmen, voor schroefbevestiging



**170-71601** Stuks: 10 Met schroefklemmen, voor schroefbevestiging

**AFWERKINGSSET**



|  |                  |           |  |                  |           |  |                  |           |
|--|------------------|-----------|--|------------------|-----------|--|------------------|-----------|
|  | <b>100-61105</b> | Stuks: 20 |  | <b>101-61105</b> | Stuks: 20 |  | <b>111-61105</b> | Stuks: 20 |
|  | <b>102-61105</b> | Stuks: 20 |  | <b>104-61105</b> | Stuks: 20 |  | <b>121-61105</b> | Stuks: 10 |
|  | <b>122-61105</b> | Stuks: 10 |  | <b>123-61105</b> | Stuks: 10 |  | <b>124-61105</b> | Stuks: 10 |
|  | <b>154-61105</b> | Stuks: 10 |  | <b>157-61105</b> | Stuks: 10 |  | <b>161-61105</b> | Stuks: 10 |
|  | <b>200-61105</b> | Stuks: 10 |  | <b>220-61105</b> | Stuks: 10 |  | <b>221-61105</b> | Stuks: 10 |

**AFWERKINGSSET MET TRANSPARANT TEKSTVELD**



|  |                  |           |  |                  |           |  |                  |           |
|--|------------------|-----------|--|------------------|-----------|--|------------------|-----------|
|  | <b>100-60905</b> | Stuks: 20 |  | <b>101-60905</b> | Stuks: 20 |  | <b>102-60905</b> | Stuks: 20 |
|  | <b>104-60905</b> | Stuks: 20 |  | <b>121-60905</b> | Stuks: 10 |  | <b>122-60905</b> | Stuks: 10 |
|  | <b>123-60905</b> | Stuks: 10 |  | <b>124-60905</b> | Stuks: 10 |  | <b>154-60905</b> | Stuks: 10 |
|  | <b>157-60905</b> | Stuks: 10 |  | <b>161-60905</b> | Stuks: 10 |  | <b>200-60905</b> | Stuks: 10 |
|  | <b>220-60905</b> | Stuks: 10 |  | <b>221-60905</b> | Stuks: 10 |  |                  |           |

**AFWERKINGSSET MET TRANSPARANT VENSTERTJE (ZIE ACCESSOIRES VOOR LEDVERLICHTINGSELEMENTEN)**



|  |                  |           |  |                  |           |  |                  |           |
|--|------------------|-----------|--|------------------|-----------|--|------------------|-----------|
|  | <b>100-60005</b> | Stuks: 20 |  | <b>101-60005</b> | Stuks: 20 |  | <b>102-60005</b> | Stuks: 20 |
|  | <b>104-60005</b> | Stuks: 20 |  | <b>121-60005</b> | Stuks: 10 |  | <b>122-60005</b> | Stuks: 10 |
|  | <b>123-60005</b> | Stuks: 10 |  | <b>124-60005</b> | Stuks: 10 |  | <b>154-60005</b> | Stuks: 10 |
|  | <b>157-60005</b> | Stuks: 10 |  | <b>161-60005</b> | Stuks: 10 |  | <b>200-60005</b> | Stuks: 10 |
|  | <b>220-60005</b> | Stuks: 10 |  | <b>221-60005</b> | Stuks: 10 |  |                  |           |

**AFWERKINGSSET VOOR MECHANISCH GECONTROLEERDE VENTILATIEBEDIENING**



|  |                  |           |  |                  |           |  |                  |           |
|--|------------------|-----------|--|------------------|-----------|--|------------------|-----------|
|  | <b>100-61106</b> | Stuks: 20 |  | <b>101-61106</b> | Stuks: 20 |  | <b>102-61106</b> | Stuks: 20 |
|  | <b>104-61106</b> | Stuks: 20 |  | <b>121-61106</b> | Stuks: 10 |  | <b>122-61106</b> | Stuks: 10 |
|  | <b>123-61106</b> | Stuks: 10 |  | <b>124-61106</b> | Stuks: 10 |  | <b>154-61106</b> | Stuks: 10 |
|  | <b>157-61106</b> | Stuks: 10 |  | <b>161-61106</b> | Stuks: 10 |  | <b>200-61106</b> | Stuks: 10 |
|  | <b>220-61106</b> | Stuks: 10 |  | <b>221-61106</b> | Stuks: 10 |  |                  |           |

**VOLLEDIG APPARAAT MET INSTEKKLEMMEN, VOOR SCHROEFBEVESTIGING**



|  |                  |           |  |                  |           |  |                  |           |
|--|------------------|-----------|--|------------------|-----------|--|------------------|-----------|
|  | <b>100-81615</b> | Stuks: 10 |  | <b>101-81615</b> | Stuks: 10 |  | <b>111-81615</b> | Stuks: 10 |
|--|------------------|-----------|--|------------------|-----------|--|------------------|-----------|



Afdekplaten afzonderlijk te bestellen.  
Afbeeldingen afgewerkte producten louter ter illustratie.



**Wisselschakelaar, 16 A**

- centerafstand: 71 mm

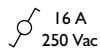
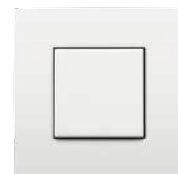
**SOKKEL**

**170-71671** Stuks: 10 Met insteekklemmen, voor schroefbevestiging



**170-71661** Stuks: 10 Met schroefklemmen, voor schroefbevestiging

**AFWERKINGSSET**

|  |                  |           |  |                  |           |  |                  |           |
|--|------------------|-----------|--|------------------|-----------|--|------------------|-----------|
|  | <b>100-61105</b> | Stuks: 20 |  | <b>101-61105</b> | Stuks: 20 |  | <b>111-61105</b> | Stuks: 20 |
|  | <b>102-61105</b> | Stuks: 20 |  | <b>104-61105</b> | Stuks: 20 |  | <b>121-61105</b> | Stuks: 10 |
|  | <b>122-61105</b> | Stuks: 10 |  | <b>123-61105</b> | Stuks: 10 |  | <b>124-61105</b> | Stuks: 10 |
|  | <b>154-61105</b> | Stuks: 10 |  | <b>157-61105</b> | Stuks: 10 |  | <b>161-61105</b> | Stuks: 10 |
|  | <b>200-61105</b> | Stuks: 10 |  | <b>220-61105</b> | Stuks: 10 |  | <b>221-61105</b> | Stuks: 10 |

**AFWERKINGSSET MET TRANSPARANT TEKSTVELD**

|  |                  |           |  |                  |           |  |                  |           |
|--|------------------|-----------|--|------------------|-----------|--|------------------|-----------|
|  | <b>100-60905</b> | Stuks: 20 |  | <b>101-60905</b> | Stuks: 20 |  | <b>102-60905</b> | Stuks: 20 |
|  | <b>104-60905</b> | Stuks: 20 |  | <b>121-60905</b> | Stuks: 10 |  | <b>122-60905</b> | Stuks: 10 |
|  | <b>123-60905</b> | Stuks: 10 |  | <b>124-60905</b> | Stuks: 10 |  | <b>154-60905</b> | Stuks: 10 |
|  | <b>157-60905</b> | Stuks: 10 |  | <b>161-60905</b> | Stuks: 10 |  | <b>200-60905</b> | Stuks: 10 |
|  | <b>220-60905</b> | Stuks: 10 |  | <b>221-60905</b> | Stuks: 10 |  |                  |           |

**AFWERKINGSSET MET TRANSPARANT VENSTERTJE (ZIE ACCESSOIRES VOOR LEDVERLICHTINGSELEMENTEN)**

|  |                  |           |  |                  |           |  |                  |           |
|--|------------------|-----------|--|------------------|-----------|--|------------------|-----------|
|  | <b>100-60005</b> | Stuks: 20 |  | <b>101-60005</b> | Stuks: 20 |  | <b>102-60005</b> | Stuks: 20 |
|  | <b>104-60005</b> | Stuks: 20 |  | <b>121-60005</b> | Stuks: 10 |  | <b>122-60005</b> | Stuks: 10 |
|  | <b>123-60005</b> | Stuks: 10 |  | <b>124-60005</b> | Stuks: 10 |  | <b>154-60005</b> | Stuks: 10 |
|  | <b>157-60005</b> | Stuks: 10 |  | <b>161-60005</b> | Stuks: 10 |  | <b>200-60005</b> | Stuks: 10 |
|  | <b>220-60005</b> | Stuks: 10 |  | <b>221-60005</b> | Stuks: 10 |  |                  |           |

**AFWERKINGSSET VOOR MECHANISCH GECONTROLEERDE VENTILATIEBEDIENING**

|  |                  |           |  |                  |           |  |                  |           |
|--|------------------|-----------|--|------------------|-----------|--|------------------|-----------|
|  | <b>100-61106</b> | Stuks: 20 |  | <b>101-61106</b> | Stuks: 20 |  | <b>102-61106</b> | Stuks: 20 |
|  | <b>104-61106</b> | Stuks: 20 |  | <b>121-61106</b> | Stuks: 10 |  | <b>122-61106</b> | Stuks: 10 |
|  | <b>123-61106</b> | Stuks: 10 |  | <b>124-61106</b> | Stuks: 10 |  | <b>154-61106</b> | Stuks: 10 |
|  | <b>157-61106</b> | Stuks: 10 |  | <b>161-61106</b> | Stuks: 10 |  | <b>200-61106</b> | Stuks: 10 |
|  | <b>220-61106</b> | Stuks: 10 |  | <b>221-61106</b> | Stuks: 10 |  |                  |           |

D.1

D.2

D.3

D.4

D.5

D.6



Afdeklatten afzonderlijk te bestellen.  
Afbeldingen afgewerkte producten louter ter illustratie.



De meest recente informatie  
vind je op [www.niko.eu](http://www.niko.eu)

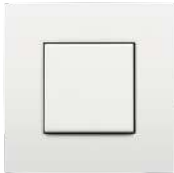

**Kruisschakelaar**

- centerafstand: 71 mm



**SOKKEL**



**170-71715** Stuks: 10 Met insteekklemmen, voor schroefbevestiging



**170-71701** Stuks: 10 Met schroefklemmen, voor schroefbevestiging

**AFWERKINGSSET**



|  |                  |           |  |                  |           |  |                  |           |
|--|------------------|-----------|--|------------------|-----------|--|------------------|-----------|
|  | <b>100-61105</b> | Stuks: 20 |  | <b>101-61105</b> | Stuks: 20 |  | <b>111-61105</b> | Stuks: 20 |
|  | <b>102-61105</b> | Stuks: 20 |  | <b>104-61105</b> | Stuks: 20 |  | <b>121-61105</b> | Stuks: 10 |
|  | <b>122-61105</b> | Stuks: 10 |  | <b>123-61105</b> | Stuks: 10 |  | <b>124-61105</b> | Stuks: 10 |
|  | <b>154-61105</b> | Stuks: 10 |  | <b>157-61105</b> | Stuks: 10 |  | <b>161-61105</b> | Stuks: 10 |
|  | <b>200-61105</b> | Stuks: 10 |  | <b>220-61105</b> | Stuks: 10 |  | <b>221-61105</b> | Stuks: 10 |

**AFWERKINGSSET MET TRANSPARANT TEKSTVELD**



|  |                  |           |  |                  |           |  |                  |           |
|--|------------------|-----------|--|------------------|-----------|--|------------------|-----------|
|  | <b>100-60905</b> | Stuks: 20 |  | <b>101-60905</b> | Stuks: 20 |  | <b>102-60905</b> | Stuks: 20 |
|  | <b>104-60905</b> | Stuks: 20 |  | <b>121-60905</b> | Stuks: 10 |  | <b>122-60905</b> | Stuks: 10 |
|  | <b>123-60905</b> | Stuks: 10 |  | <b>124-60905</b> | Stuks: 10 |  | <b>154-60905</b> | Stuks: 10 |
|  | <b>157-60905</b> | Stuks: 10 |  | <b>161-60905</b> | Stuks: 10 |  | <b>200-60905</b> | Stuks: 10 |
|  | <b>220-60905</b> | Stuks: 10 |  | <b>221-60905</b> | Stuks: 10 |  |                  |           |

**AFWERKINGSSET MET TRANSPARANT VENSTERTJE (ZIE ACCESSOIRES VOOR LEDVERLICHTINGSELEMENTEN)**



|  |                  |           |  |                  |           |  |                  |           |
|--|------------------|-----------|--|------------------|-----------|--|------------------|-----------|
|  | <b>100-60005</b> | Stuks: 20 |  | <b>101-60005</b> | Stuks: 20 |  | <b>102-60005</b> | Stuks: 20 |
|  | <b>104-60005</b> | Stuks: 20 |  | <b>121-60005</b> | Stuks: 10 |  | <b>122-60005</b> | Stuks: 10 |
|  | <b>123-60005</b> | Stuks: 10 |  | <b>124-60005</b> | Stuks: 10 |  | <b>154-60005</b> | Stuks: 10 |
|  | <b>157-60005</b> | Stuks: 10 |  | <b>161-60005</b> | Stuks: 10 |  | <b>200-60005</b> | Stuks: 10 |
|  | <b>220-60005</b> | Stuks: 10 |  | <b>221-60005</b> | Stuks: 10 |  |                  |           |

**VOLLEDIG APPARAAT MET INSTEKKLEMMEN, VOOR SCHROEFBEVESTIGING**



|  |                  |           |  |                  |           |  |                  |           |
|--|------------------|-----------|--|------------------|-----------|--|------------------|-----------|
|  | <b>100-81715</b> | Stuks: 10 |  | <b>101-81715</b> | Stuks: 10 |  | <b>111-81715</b> | Stuks: 10 |
|--|------------------|-----------|--|------------------|-----------|--|------------------|-----------|



Afdeklatten afzonderlijk te bestellen.  
Afbeeldingen afgewerkte producten louter ter illustratie.

**Tweepolige wisselschakelaar**

- centerafstand: 71 mm

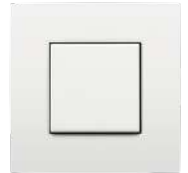
**SOKKEL**

**170-72215** Stuks: 10 Met insteekklemmen, voor schroefbevestiging



**170-72201** Stuks: 10 Met schroefklemmen, voor schroefbevestiging

**AFWERKINGSSET**

|  |                  |           |  |                  |           |  |                  |           |
|--|------------------|-----------|--|------------------|-----------|--|------------------|-----------|
|  | <b>100-61105</b> | Stuks: 20 |  | <b>101-61105</b> | Stuks: 20 |  | <b>111-61105</b> | Stuks: 20 |
|  | <b>102-61105</b> | Stuks: 20 |  | <b>104-61105</b> | Stuks: 20 |  | <b>121-61105</b> | Stuks: 10 |
|  | <b>122-61105</b> | Stuks: 10 |  | <b>123-61105</b> | Stuks: 10 |  | <b>124-61105</b> | Stuks: 10 |
|  | <b>154-61105</b> | Stuks: 10 |  | <b>157-61105</b> | Stuks: 10 |  | <b>161-61105</b> | Stuks: 10 |
|  | <b>200-61105</b> | Stuks: 10 |  | <b>220-61105</b> | Stuks: 10 |  | <b>221-61105</b> | Stuks: 10 |

**AFWERKINGSSET MET TRANSPARANT TEKSTVELD**

|  |                  |           |  |                  |           |  |                  |           |
|--|------------------|-----------|--|------------------|-----------|--|------------------|-----------|
|  | <b>100-60905</b> | Stuks: 20 |  | <b>101-60905</b> | Stuks: 20 |  | <b>102-60905</b> | Stuks: 20 |
|  | <b>104-60905</b> | Stuks: 20 |  | <b>121-60905</b> | Stuks: 10 |  | <b>122-60905</b> | Stuks: 10 |
|  | <b>123-60905</b> | Stuks: 10 |  | <b>124-60905</b> | Stuks: 10 |  | <b>154-60905</b> | Stuks: 10 |
|  | <b>157-60905</b> | Stuks: 10 |  | <b>161-60905</b> | Stuks: 10 |  | <b>200-60905</b> | Stuks: 10 |
|  | <b>220-60905</b> | Stuks: 10 |  | <b>221-60905</b> | Stuks: 10 |  |                  |           |

**AFWERKINGSSET MET TRANSPARANT VENSTERTJE (ZIE ACCESSOIRES VOOR LEDVERLICHTINGSELEMENTEN)**

|  |                  |           |  |                  |           |  |                  |           |
|--|------------------|-----------|--|------------------|-----------|--|------------------|-----------|
|  | <b>100-60005</b> | Stuks: 20 |  | <b>101-60005</b> | Stuks: 20 |  | <b>102-60005</b> | Stuks: 20 |
|  | <b>104-60005</b> | Stuks: 20 |  | <b>121-60005</b> | Stuks: 10 |  | <b>122-60005</b> | Stuks: 10 |
|  | <b>123-60005</b> | Stuks: 10 |  | <b>124-60005</b> | Stuks: 10 |  | <b>154-60005</b> | Stuks: 10 |
|  | <b>157-60005</b> | Stuks: 10 |  | <b>161-60005</b> | Stuks: 10 |  | <b>200-60005</b> | Stuks: 10 |
|  | <b>220-60005</b> | Stuks: 10 |  | <b>221-60005</b> | Stuks: 10 |  |                  |           |

**AFWERKINGSSET VOOR MECHANISCH GECONTROLEERDE VENTILATIEBEDIENING**

|  |                  |           |  |                  |           |  |                  |           |
|--|------------------|-----------|--|------------------|-----------|--|------------------|-----------|
|  | <b>100-61106</b> | Stuks: 20 |  | <b>101-61106</b> | Stuks: 20 |  | <b>102-61106</b> | Stuks: 20 |
|  | <b>104-61106</b> | Stuks: 20 |  | <b>121-61106</b> | Stuks: 10 |  | <b>122-61106</b> | Stuks: 10 |
|  | <b>123-61106</b> | Stuks: 10 |  | <b>124-61106</b> | Stuks: 10 |  | <b>154-61106</b> | Stuks: 10 |
|  | <b>157-61106</b> | Stuks: 10 |  | <b>161-61106</b> | Stuks: 10 |  | <b>200-61106</b> | Stuks: 10 |
|  | <b>220-61106</b> | Stuks: 10 |  | <b>221-61106</b> | Stuks: 10 |  |                  |           |

D.1

D.2

D.3

D.4

D.5

D.6



Afdeklatten afzonderlijk te bestellen.  
Afbeldingen afgewerkte producten louter ter illustratie.



De meest recente informatie  
vind je op [www.niko.eu](http://www.niko.eu)



**Hotelkaartschakelaar, NO of NG**

Het ledverlichtingselement moet afzonderlijk worden besteld (zie accessoires). Deze schakelaar is geschikt voor kaarten met een dikte van 0,75 tot 1,2 mm en een breedte van 45 tot 54 mm.

- centerafstand: 71 mm

**SOKKEL**

















**170-73015** Stuks: 10 Met insteekklemmen, voor schroefbevestiging



**170-73001** Stuks: 10 Met schroefklemmen, voor schroefbevestiging

**AFWERKINGSSET**



|   |                  |           |   |                  |           |   |                  |           |
|---|------------------|-----------|---|------------------|-----------|---|------------------|-----------|
|  | <b>100-61901</b> | Stuks: 10 |  | <b>101-61901</b> | Stuks: 10 |  | <b>102-61901</b> | Stuks: 10 |
|  | <b>104-61901</b> | Stuks: 10 |  | <b>121-61901</b> | Stuks: 10 |  | <b>122-61901</b> | Stuks: 10 |
|  | <b>123-61901</b> | Stuks: 10 |  | <b>124-61901</b> | Stuks: 10 |  | <b>154-61901</b> | Stuks: 10 |
|  | <b>157-61901</b> | Stuks: 10 |  | <b>161-61901</b> | Stuks: 10 |  | <b>200-61901</b> | Stuks: 10 |
|  | <b>220-61901</b> | Stuks: 10 |  | <b>221-61901</b> | Stuks: 10 |   |                  |           |



**Serieschakelaar**

- centerafstand: 71 mm

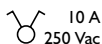

**SOKKEL**

















**170-71515** Stuks: 10 Met insteekklemmen, voor schroefbevestiging



**170-71501** Stuks: 10 Met schroefklemmen, voor schroefbevestiging















**AFWERKINGSSET**



|   |                  |           |   |                  |           |   |                  |           |
|---|------------------|-----------|---|------------------|-----------|---|------------------|-----------|
|  | <b>100-61505</b> | Stuks: 20 |  | <b>101-61505</b> | Stuks: 20 |  | <b>111-61505</b> | Stuks: 20 |
|  | <b>102-61505</b> | Stuks: 20 |  | <b>104-61505</b> | Stuks: 20 |  | <b>121-61505</b> | Stuks: 10 |
|  | <b>122-61505</b> | Stuks: 10 |  | <b>123-61505</b> | Stuks: 10 |  | <b>124-61505</b> | Stuks: 10 |
|  | <b>154-61505</b> | Stuks: 10 |  | <b>157-61505</b> | Stuks: 10 |  | <b>161-61505</b> | Stuks: 10 |
|  | <b>200-61505</b> | Stuks: 10 |  | <b>220-61505</b> | Stuks: 10 |  | <b>221-61505</b> | Stuks: 10 |

**AFWERKINGSSET MET TWEE TRANSPARANTE VENSTERTJES (ZIE ACCESSOIRES VOOR LEDVERLICHTINGSELEMENTEN)**



|   |                  |           |   |                  |           |   |                  |           |
|---|------------------|-----------|---|------------------|-----------|---|------------------|-----------|
|  | <b>100-61507</b> | Stuks: 20 |  | <b>101-61507</b> | Stuks: 20 |  | <b>102-61507</b> | Stuks: 20 |
|  | <b>104-61507</b> | Stuks: 20 |  | <b>121-61507</b> | Stuks: 10 |  | <b>122-61507</b> | Stuks: 10 |
|  | <b>123-61507</b> | Stuks: 10 |  | <b>124-61507</b> | Stuks: 10 |  | <b>154-61507</b> | Stuks: 10 |
|  | <b>157-61507</b> | Stuks: 10 |  | <b>161-61507</b> | Stuks: 10 |  | <b>200-61507</b> | Stuks: 10 |
|  | <b>220-61507</b> | Stuks: 10 |  | <b>221-61507</b> | Stuks: 10 |   |                  |           |

**VOLLEDIG APPARAAT MET INSTEKKLEMMEN, VOOR SCHROEFBEVESTIGING**



**100-81515** Stuks: 10 **101-81515** Stuks: 10 **111-81515** Stuks: 10



Afdeklatten afzonderlijk te bestellen.  
Afbeeldingen afgewerkte producten louter ter illustratie.

**Wisselschakelaar + NO-drukknop**

- centerafstand: 71 mm

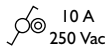
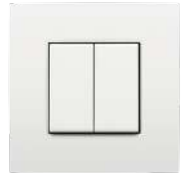
**SOKKEL**

**170-75615** Stuks: 10 Met insteekklemmen, voor schroefbevestiging



**170-75601** Stuks: 10 Met schroefklemmen, voor schroefbevestiging

**AFWERKINGSSET**

|  |                  |           |  |                  |           |  |                  |           |
|--|------------------|-----------|--|------------------|-----------|--|------------------|-----------|
|  | <b>100-61505</b> | Stuks: 20 |  | <b>101-61505</b> | Stuks: 20 |  | <b>111-61505</b> | Stuks: 20 |
|  | <b>102-61505</b> | Stuks: 20 |  | <b>104-61505</b> | Stuks: 20 |  | <b>121-61505</b> | Stuks: 10 |
|  | <b>122-61505</b> | Stuks: 10 |  | <b>123-61505</b> | Stuks: 10 |  | <b>124-61505</b> | Stuks: 10 |
|  | <b>154-61505</b> | Stuks: 10 |  | <b>157-61505</b> | Stuks: 10 |  | <b>161-61505</b> | Stuks: 10 |
|  | <b>200-61505</b> | Stuks: 10 |  | <b>220-61505</b> | Stuks: 10 |  | <b>221-61505</b> | Stuks: 10 |

**AFWERKINGSSET MET TWEE TRANSPARANTE VENSTERTJES (ZIE ACCESSOIRES VOOR LEDVERLICHTINGSELEMENTEN)**

|  |                  |           |  |                  |           |  |                  |           |
|--|------------------|-----------|--|------------------|-----------|--|------------------|-----------|
|  | <b>100-61507</b> | Stuks: 20 |  | <b>101-61507</b> | Stuks: 20 |  | <b>102-61507</b> | Stuks: 20 |
|  | <b>104-61507</b> | Stuks: 20 |  | <b>121-61507</b> | Stuks: 10 |  | <b>122-61507</b> | Stuks: 10 |
|  | <b>123-61507</b> | Stuks: 10 |  | <b>124-61507</b> | Stuks: 10 |  | <b>154-61507</b> | Stuks: 10 |
|  | <b>157-61507</b> | Stuks: 10 |  | <b>161-61507</b> | Stuks: 10 |  | <b>200-61507</b> | Stuks: 10 |
|  | <b>220-61507</b> | Stuks: 10 |  | <b>221-61507</b> | Stuks: 10 |  |                  |           |

**Tweevoudige wisselschakelaar**

- centerafstand: 71 mm

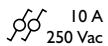
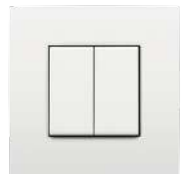
**SOKKEL**

**170-72615** Stuks: 10 Met insteekklemmen, voor schroefbevestiging



**170-72601** Stuks: 10 Met schroefklemmen, voor schroefbevestiging

**AFWERKINGSSET**

|  |                  |           |  |                  |           |  |                  |           |
|--|------------------|-----------|--|------------------|-----------|--|------------------|-----------|
|  | <b>100-61505</b> | Stuks: 20 |  | <b>101-61505</b> | Stuks: 20 |  | <b>111-61505</b> | Stuks: 20 |
|  | <b>102-61505</b> | Stuks: 20 |  | <b>104-61505</b> | Stuks: 20 |  | <b>121-61505</b> | Stuks: 10 |
|  | <b>122-61505</b> | Stuks: 10 |  | <b>123-61505</b> | Stuks: 10 |  | <b>124-61505</b> | Stuks: 10 |
|  | <b>154-61505</b> | Stuks: 10 |  | <b>157-61505</b> | Stuks: 10 |  | <b>161-61505</b> | Stuks: 10 |
|  | <b>200-61505</b> | Stuks: 10 |  | <b>220-61505</b> | Stuks: 10 |  | <b>221-61505</b> | Stuks: 10 |

**AFWERKINGSSET MET TWEE TRANSPARANTE VENSTERTJES (ZIE ACCESSOIRES VOOR LEDVERLICHTINGSELEMENTEN)**

|  |                  |           |  |                  |           |  |                  |           |
|--|------------------|-----------|--|------------------|-----------|--|------------------|-----------|
|  | <b>100-61507</b> | Stuks: 20 |  | <b>101-61507</b> | Stuks: 20 |  | <b>102-61507</b> | Stuks: 20 |
|  | <b>104-61507</b> | Stuks: 20 |  | <b>121-61507</b> | Stuks: 10 |  | <b>122-61507</b> | Stuks: 10 |
|  | <b>123-61507</b> | Stuks: 10 |  | <b>124-61507</b> | Stuks: 10 |  | <b>154-61507</b> | Stuks: 10 |
|  | <b>157-61507</b> | Stuks: 10 |  | <b>161-61507</b> | Stuks: 10 |  | <b>200-61507</b> | Stuks: 10 |
|  | <b>220-61507</b> | Stuks: 10 |  | <b>221-61507</b> | Stuks: 10 |  |                  |           |



Afdeklatten afzonderlijk te bestellen.  
Afbeldingen afgewerkte producten louter ter illustratie.



De meest recente informatie  
vindt je op [www.niko.eu](http://www.niko.eu)

D.1

D.2

D.3

D.4

D.5

D.6



**Enkelpolige controleschakelaar met drie aansluitklemmen**

- centerafstand: 71 mm



**SOKKEL**



**170-77115** Stuks: 10 Met insteekklemmen, voor schroefbevestiging



**170-77101** Stuks: 10 Met schroefklemmen, voor schroefbevestiging

**AFWERKINGSSET MET TRANSPARANT VENSTERTJE (ZIE ACCESSOIRES VOOR LEDVERLICHTINGSELEMENTEN)**



|  |                  |           |  |                  |           |  |                  |           |
|--|------------------|-----------|--|------------------|-----------|--|------------------|-----------|
|  | <b>100-60005</b> | Stuks: 20 |  | <b>101-60005</b> | Stuks: 20 |  | <b>102-60005</b> | Stuks: 20 |
|  | <b>104-60005</b> | Stuks: 20 |  | <b>121-60005</b> | Stuks: 10 |  | <b>122-60005</b> | Stuks: 10 |
|  | <b>123-60005</b> | Stuks: 10 |  | <b>124-60005</b> | Stuks: 10 |  | <b>154-60005</b> | Stuks: 10 |
|  | <b>157-60005</b> | Stuks: 10 |  | <b>161-60005</b> | Stuks: 10 |  | <b>200-60005</b> | Stuks: 10 |
|  | <b>220-60005</b> | Stuks: 10 |  | <b>221-60005</b> | Stuks: 10 |  |                  |           |



**Tweepolige controleschakelaar**

- centerafstand: 71 mm



**SOKKEL**



**170-71215** Stuks: 10 Met insteekklemmen, voor schroefbevestiging



**170-71201** Stuks: 10 Met schroefklemmen, voor schroefbevestiging

**AFWERKINGSSET MET TRANSPARANT VENSTERTJE (ZIE ACCESSOIRES VOOR LEDVERLICHTINGSELEMENTEN)**



|  |                  |           |  |                  |           |  |                  |           |
|--|------------------|-----------|--|------------------|-----------|--|------------------|-----------|
|  | <b>100-60005</b> | Stuks: 20 |  | <b>101-60005</b> | Stuks: 20 |  | <b>102-60005</b> | Stuks: 20 |
|  | <b>104-60005</b> | Stuks: 20 |  | <b>121-60005</b> | Stuks: 10 |  | <b>122-60005</b> | Stuks: 10 |
|  | <b>123-60005</b> | Stuks: 10 |  | <b>124-60005</b> | Stuks: 10 |  | <b>154-60005</b> | Stuks: 10 |
|  | <b>157-60005</b> | Stuks: 10 |  | <b>161-60005</b> | Stuks: 10 |  | <b>200-60005</b> | Stuks: 10 |
|  | <b>220-60005</b> | Stuks: 10 |  | <b>221-60005</b> | Stuks: 10 |  |                  |           |



Afdeklatten afzonderlijk te bestellen.  
Afbelingen afgewerkte producten louter ter illustratie.

**Tweepolige controleschakelaar, 16 A**

- centerafstand: 71 mm



 16 A  
250 Vac















**SOKKEL**

**170-71315** Stuks: 10 Met insteekklemmen, voor schroefbevestiging



**170-71301** Stuks: 10 Met schroefklemmen, voor schroefbevestiging

**AFWERKINGSSET MET TRANSPARANT VENSTERTJE (ZIE ACCESSOIRES VOOR LEDVERLICHTINGSELEMENTEN)**

|   |                  |           |   |                  |           |   |                  |           |
|---|------------------|-----------|---|------------------|-----------|---|------------------|-----------|
|  | <b>100-60005</b> | Stuks: 20 |  | <b>101-60005</b> | Stuks: 20 |  | <b>102-60005</b> | Stuks: 20 |
|  | <b>104-60005</b> | Stuks: 20 |  | <b>121-60005</b> | Stuks: 10 |  | <b>122-60005</b> | Stuks: 10 |
|  | <b>123-60005</b> | Stuks: 10 |  | <b>124-60005</b> | Stuks: 10 |  | <b>154-60005</b> | Stuks: 10 |
|  | <b>157-60005</b> | Stuks: 10 |  | <b>161-60005</b> | Stuks: 10 |  | <b>200-60005</b> | Stuks: 10 |
|  | <b>220-60005</b> | Stuks: 10 |  | <b>221-60005</b> | Stuks: 10 |   |                  |           |

**Wisselcontroleschakelaar met vier aansluitklemmen**

- centerafstand: 71 mm



 10 A  
250 Vac















**SOKKEL**

**170-77615** Stuks: 10 Met insteekklemmen, voor schroefbevestiging



**170-77601** Stuks: 10 Met schroefklemmen, voor schroefbevestiging

**AFWERKINGSSET MET TRANSPARANT VENSTERTJE (ZIE ACCESSOIRES VOOR LEDVERLICHTINGSELEMENTEN)**

|   |                  |           |   |                  |           |   |                  |           |
|---|------------------|-----------|---|------------------|-----------|---|------------------|-----------|
|  | <b>100-60005</b> | Stuks: 20 |  | <b>101-60005</b> | Stuks: 20 |  | <b>102-60005</b> | Stuks: 20 |
|  | <b>104-60005</b> | Stuks: 20 |  | <b>121-60005</b> | Stuks: 10 |  | <b>122-60005</b> | Stuks: 10 |
|  | <b>123-60005</b> | Stuks: 10 |  | <b>124-60005</b> | Stuks: 10 |  | <b>154-60005</b> | Stuks: 10 |
|  | <b>157-60005</b> | Stuks: 10 |  | <b>161-60005</b> | Stuks: 10 |  | <b>200-60005</b> | Stuks: 10 |
|  | <b>220-60005</b> | Stuks: 10 |  | <b>221-60005</b> | Stuks: 10 |   |                  |           |

D.1

D.2

D.3

D.4

D.5

D.6



Afdeklatten afzonderlijk te bestellen.  
Afbeeldingen afgewerkte producten louter ter illustratie.



De meest recente informatie  
vind je op [www.niko.eu](http://www.niko.eu)



**Tweepolige trekschakelaar**

- centerafstand: 71 mm



**SOKKEL**



**170-71215** Stuks: 10

Met insteekklemmen, voor schroefbevestiging



**170-71201** Stuks: 10

Met schroefklemmen, voor schroefbevestiging

**AFWERKINGSSET**



|  |                  |           |
|--|------------------|-----------|
|  | <b>100-63606</b> | Stuks: 10 |
|  | <b>104-63606</b> | Stuks: 10 |
|  | <b>123-63606</b> | Stuks: 10 |
|  | <b>157-63606</b> | Stuks: 10 |
|  | <b>220-63606</b> | Stuks: 10 |

|  |                  |           |
|--|------------------|-----------|
|  | <b>101-63606</b> | Stuks: 10 |
|  | <b>121-63606</b> | Stuks: 10 |
|  | <b>124-63606</b> | Stuks: 10 |
|  | <b>161-63606</b> | Stuks: 10 |
|  | <b>221-63606</b> | Stuks: 10 |

|  |                  |           |
|--|------------------|-----------|
|  | <b>102-63606</b> | Stuks: 10 |
|  | <b>122-63606</b> | Stuks: 10 |
|  | <b>154-63606</b> | Stuks: 10 |
|  | <b>200-63606</b> | Stuks: 10 |



**Tweepolige trekschakelaar, 16 A**

- centerafstand: 71 mm



**SOKKEL**



**170-71315** Stuks: 10

Met insteekklemmen, voor schroefbevestiging



**170-71301** Stuks: 10

Met schroefklemmen, voor schroefbevestiging

**AFWERKINGSSET**



|  |                  |           |
|--|------------------|-----------|
|  | <b>100-63606</b> | Stuks: 10 |
|  | <b>104-63606</b> | Stuks: 10 |
|  | <b>123-63606</b> | Stuks: 10 |
|  | <b>157-63606</b> | Stuks: 10 |
|  | <b>220-63606</b> | Stuks: 10 |

|  |                  |           |
|--|------------------|-----------|
|  | <b>101-63606</b> | Stuks: 10 |
|  | <b>121-63606</b> | Stuks: 10 |
|  | <b>124-63606</b> | Stuks: 10 |
|  | <b>161-63606</b> | Stuks: 10 |
|  | <b>221-63606</b> | Stuks: 10 |

|  |                  |           |
|--|------------------|-----------|
|  | <b>102-63606</b> | Stuks: 10 |
|  | <b>122-63606</b> | Stuks: 10 |
|  | <b>154-63606</b> | Stuks: 10 |
|  | <b>200-63606</b> | Stuks: 10 |



Afdeklatten afzonderlijk te bestellen.  
Afbeldingen afgewerkte producten louter ter illustratie.



**Wisseltrekschakelaar**

- centerafstand: 71 mm

**SOKKEL**

**170-71615** Stuks: 10 Met insteekklemmen, voor schroefbevestiging



**170-71601** Stuks: 10 Met schroefklemmen, voor schroefbevestiging

**AFWERKINGSSET**

|  |                  |           |  |                  |           |  |                  |           |
|--|------------------|-----------|--|------------------|-----------|--|------------------|-----------|
|  | <b>100-63606</b> | Stuks: 10 |  | <b>101-63606</b> | Stuks: 10 |  | <b>102-63606</b> | Stuks: 10 |
|  | <b>104-63606</b> | Stuks: 10 |  | <b>121-63606</b> | Stuks: 10 |  | <b>122-63606</b> | Stuks: 10 |
|  | <b>123-63606</b> | Stuks: 10 |  | <b>124-63606</b> | Stuks: 10 |  | <b>154-63606</b> | Stuks: 10 |
|  | <b>157-63606</b> | Stuks: 10 |  | <b>161-63606</b> | Stuks: 10 |  | <b>200-63606</b> | Stuks: 10 |
|  | <b>220-63606</b> | Stuks: 10 |  | <b>221-63606</b> | Stuks: 10 |  |                  |           |

**Wisseltrekschakelaar, 16 A**

- centerafstand: 71 mm

**SOKKEL**

**170-71671** Stuks: 10 Met insteekklemmen, voor schroefbevestiging

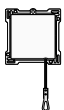

**170-71661** Stuks: 10 Met schroefklemmen, voor schroefbevestiging

**AFWERKINGSSET**

|  |                  |           |  |                  |           |  |                  |           |
|--|------------------|-----------|--|------------------|-----------|--|------------------|-----------|
|  | <b>100-63606</b> | Stuks: 10 |  | <b>101-63606</b> | Stuks: 10 |  | <b>102-63606</b> | Stuks: 10 |
|  | <b>104-63606</b> | Stuks: 10 |  | <b>121-63606</b> | Stuks: 10 |  | <b>122-63606</b> | Stuks: 10 |
|  | <b>123-63606</b> | Stuks: 10 |  | <b>124-63606</b> | Stuks: 10 |  | <b>154-63606</b> | Stuks: 10 |
|  | <b>157-63606</b> | Stuks: 10 |  | <b>161-63606</b> | Stuks: 10 |  | <b>200-63606</b> | Stuks: 10 |
|  | <b>220-63606</b> | Stuks: 10 |  | <b>221-63606</b> | Stuks: 10 |  |                  |           |

D.1

D.2

D.3

D.4

D.5

D.6



Afdeklatten afzonderlijk te bestellen.  
Afbeeldingen afgewerkte producten louter ter illustratie.



De meest recente informatie  
vind je op [www.niko.eu](http://www.niko.eu)



**Kruistrekschakelaar**

- centerafstand: 71 mm



**SOKKEL**



**170-71715** Stuks: 10

Met insteekklemmen, voor schroefbevestiging



**170-71701** Stuks: 10

Met schroefklemmen, voor schroefbevestiging

**AFWERKINGSSET**



|  |                  |           |
|--|------------------|-----------|
|  | <b>100-63606</b> | Stuks: 10 |
|  | <b>104-63606</b> | Stuks: 10 |
|  | <b>123-63606</b> | Stuks: 10 |
|  | <b>157-63606</b> | Stuks: 10 |
|  | <b>220-63606</b> | Stuks: 10 |

|  |                  |           |
|--|------------------|-----------|
|  | <b>101-63606</b> | Stuks: 10 |
|  | <b>121-63606</b> | Stuks: 10 |
|  | <b>124-63606</b> | Stuks: 10 |
|  | <b>161-63606</b> | Stuks: 10 |
|  | <b>221-63606</b> | Stuks: 10 |

|  |                  |           |
|--|------------------|-----------|
|  | <b>102-63606</b> | Stuks: 10 |
|  | <b>122-63606</b> | Stuks: 10 |
|  | <b>154-63606</b> | Stuks: 10 |
|  | <b>200-63606</b> | Stuks: 10 |



**Trekdrukknop, NO of NG**

- centerafstand: 71 mm

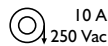

**SOKKEL**



**170-73015** Stuks: 10

Met insteekklemmen, voor schroefbevestiging



**170-73001** Stuks: 10

Met schroefklemmen, voor schroefbevestiging

**AFWERKINGSSET**

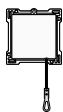

|  |                  |           |
|--|------------------|-----------|
|  | <b>100-63906</b> | Stuks: 10 |
|  | <b>104-63906</b> | Stuks: 10 |
|  | <b>123-63906</b> | Stuks: 10 |
|  | <b>157-63906</b> | Stuks: 10 |
|  | <b>220-63906</b> | Stuks: 10 |

|  |                  |           |
|--|------------------|-----------|
|  | <b>101-63906</b> | Stuks: 10 |
|  | <b>121-63906</b> | Stuks: 10 |
|  | <b>124-63906</b> | Stuks: 10 |
|  | <b>161-63906</b> | Stuks: 10 |
|  | <b>221-63906</b> | Stuks: 10 |

|  |                  |           |
|--|------------------|-----------|
|  | <b>102-63906</b> | Stuks: 10 |
|  | <b>122-63906</b> | Stuks: 10 |
|  | <b>154-63906</b> | Stuks: 10 |
|  | <b>200-63906</b> | Stuks: 10 |



Afdeklatten afzonderlijk te bestellen.  
Afbeeldingen afgewerkte producten louter ter illustratie.

**Tweepolige tijdschakelaar instelbaar tot 15 minuten, 16 A**

Gebruik CE-gemarkeerde inbouwdozen voor schroefbevestiging met een inbouwdiepte van 50 mm.















- inbouwdiepte: 40 mm

 16 A  
250 Vac
**SOKKEL****170-04800**

Stuks: 6

Met schroefklemmen, voor schroefbevestiging

**AFWERKINGSSET**

|   |                  |           |   |                  |           |   |                  |           |
|---|------------------|-----------|---|------------------|-----------|---|------------------|-----------|
|  | <b>100-64806</b> | Stuks: 10 |  | <b>101-64806</b> | Stuks: 10 |  | <b>102-64806</b> | Stuks: 10 |
|  | <b>104-64806</b> | Stuks: 10 |  | <b>121-64806</b> | Stuks: 10 |  | <b>122-64806</b> | Stuks: 10 |
|  | <b>123-64806</b> | Stuks: 10 |  | <b>124-64806</b> | Stuks: 10 |  | <b>154-64806</b> | Stuks: 10 |
|  | <b>157-64806</b> | Stuks: 10 |  | <b>161-64806</b> | Stuks: 10 |  | <b>200-64806</b> | Stuks: 10 |
|  | <b>220-64806</b> | Stuks: 10 |  | <b>221-64806</b> | Stuks: 10 |   |                  |           |

**Tweepolige tijdschakelaar instelbaar tot 120 minuten, 16 A**

Gebruik CE-gemarkeerde inbouwdozen voor schroefbevestiging met een inbouwdiepte van 50 mm.















- inbouwdiepte: 40 mm

 16 A  
250 Vac
**SOKKEL****170-04900**

Stuks: 6

Met schroefklemmen, voor schroefbevestiging

**AFWERKINGSSET**

|   |                  |           |   |                  |           |   |                  |           |
|---|------------------|-----------|---|------------------|-----------|---|------------------|-----------|
|  | <b>100-64906</b> | Stuks: 10 |  | <b>101-64906</b> | Stuks: 10 |  | <b>102-64906</b> | Stuks: 10 |
|  | <b>104-64906</b> | Stuks: 10 |  | <b>121-64906</b> | Stuks: 10 |  | <b>122-64906</b> | Stuks: 10 |
|  | <b>123-64906</b> | Stuks: 10 |  | <b>124-64906</b> | Stuks: 10 |  | <b>154-64906</b> | Stuks: 10 |
|  | <b>157-64906</b> | Stuks: 10 |  | <b>161-64906</b> | Stuks: 10 |  | <b>200-64906</b> | Stuks: 10 |
|  | <b>220-64906</b> | Stuks: 10 |  | <b>221-64906</b> | Stuks: 10 |   |                  |           |



D.1

D.2

D.3

D.4

D.5

D.6



Afdeklatten afzonderlijk te bestellen.  
Afbeeldingen afgewerkte producten louter ter illustratie.



De meest recente informatie  
vind je op [www.niko.eu](http://www.niko.eu)



**Rolluikschakelaar, elektrisch gescheiden**

Deze schakelaar wordt gebruikt om de motoren te bedienen van onder meer rolluiken, garagepoorten, jaloezieën en markiezen.

Als je de draairichting wil veranderen, moet je eerst de linkertoets op 'STOP' plaatsen, dan op het juiste pijltje drukken op de rechtertoets en vervolgens opnieuw op 'START' drukken.

- centerafstand: 71 mm



**SOKKEL**



**170-75915** Stuks: 10 Met insteekklemmen, voor schroefbevestiging



**170-75901** Stuks: 10 Met schroefklemmen, voor schroefbevestiging

**AFWERKINGSSET**



|  |                  |           |  |                  |           |  |                  |           |
|--|------------------|-----------|--|------------------|-----------|--|------------------|-----------|
|  | <b>100-65905</b> | Stuks: 10 |  | <b>101-65905</b> | Stuks: 10 |  | <b>102-65905</b> | Stuks: 10 |
|  | <b>104-65905</b> | Stuks: 10 |  | <b>121-65905</b> | Stuks: 10 |  | <b>122-65905</b> | Stuks: 10 |
|  | <b>123-65905</b> | Stuks: 10 |  | <b>124-65905</b> | Stuks: 10 |  | <b>154-65905</b> | Stuks: 10 |
|  | <b>157-65905</b> | Stuks: 10 |  | <b>161-65905</b> | Stuks: 10 |  | <b>200-65905</b> | Stuks: 10 |
|  | <b>220-65905</b> | Stuks: 10 |  | <b>221-65905</b> | Stuks: 10 |  |                  |           |



**Rolluikdrukknop, elektrisch gescheiden**

Deze drukknop wordt gebruikt om de motoren te bedienen van onder meer rolluiken, garagepoorten, jaloezieën en markiezen.

- centerafstand: 71 mm

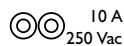

**SOKKEL**



**170-85915** Stuks: 10 Met insteekklemmen, voor schroefbevestiging



**170-85901** Stuks: 10 Met schroefklemmen, voor schroefbevestiging

**AFWERKINGSSET**



|  |                  |           |  |                  |           |  |                  |           |
|--|------------------|-----------|--|------------------|-----------|--|------------------|-----------|
|  | <b>100-65914</b> | Stuks: 10 |  | <b>101-65914</b> | Stuks: 10 |  | <b>111-65914</b> | Stuks: 10 |
|  | <b>102-65914</b> | Stuks: 10 |  | <b>104-65914</b> | Stuks: 10 |  | <b>121-65914</b> | Stuks: 10 |
|  | <b>122-65914</b> | Stuks: 10 |  | <b>123-65914</b> | Stuks: 10 |  | <b>124-65914</b> | Stuks: 10 |
|  | <b>154-65914</b> | Stuks: 10 |  | <b>157-65914</b> | Stuks: 10 |  | <b>161-65914</b> | Stuks: 10 |
|  | <b>200-65914</b> | Stuks: 10 |  | <b>220-65914</b> | Stuks: 10 |  | <b>221-65914</b> | Stuks: 10 |



Afdeklatten afzonderlijk te bestellen.  
Afbeeldingen afgewerkte producten louter ter illustratie.

**Rolluikdrukknop, voor elektronische bedieningen**

Deze drukknop wordt gebruikt om de motoren te bedienen van onder meer rolluiken, garagepoorten, jaloezieën en markiezen.

- centerafstand: 71 mm

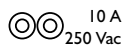













**SOKKEL**

**170-95915** Stuks: 10 Met insteekklemmen, voor schroefbevestiging



**170-95901** Stuks: 10 Met schroefklemmen, voor schroefbevestiging

**AFWERKINGSSET**

|   |                  |           |   |                  |           |   |                  |           |
|---|------------------|-----------|---|------------------|-----------|---|------------------|-----------|
|  | <b>100-65918</b> | Stuks: 10 |  | <b>101-65918</b> | Stuks: 10 |  | <b>102-65918</b> | Stuks: 10 |
|  | <b>104-65918</b> | Stuks: 10 |  | <b>121-65918</b> | Stuks: 10 |  | <b>122-65918</b> | Stuks: 10 |
|  | <b>123-65918</b> | Stuks: 10 |  | <b>124-65918</b> | Stuks: 10 |  | <b>154-65918</b> | Stuks: 10 |
|  | <b>157-65918</b> | Stuks: 10 |  | <b>161-65918</b> | Stuks: 10 |  | <b>200-65918</b> | Stuks: 10 |
|  | <b>220-65918</b> | Stuks: 10 |  | <b>221-65918</b> | Stuks: 10 |   |                  |           |

**Impulsgever met draaibediening, 25 A**





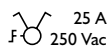









De impulsgever met draaibediening wordt gebruikt om de motoren te bedienen van onder meer rolluiken, garagepoorten en jaloezieën.

- centerafstand: 71 mm

**SOKKEL**

**170-35901** Stuks: 10 Met schroefklemmen, voor schroefbevestiging

**AFWERKINGSSET (UP/DOWN)**

|   |                  |           |   |                  |           |   |                  |           |
|---|------------------|-----------|---|------------------|-----------|---|------------------|-----------|
|  | <b>100-65926</b> | Stuks: 10 |  | <b>101-65926</b> | Stuks: 10 |  | <b>102-65926</b> | Stuks: 10 |
|  | <b>104-65926</b> | Stuks: 10 |  | <b>121-65926</b> | Stuks: 10 |  | <b>122-65926</b> | Stuks: 10 |
|  | <b>123-65926</b> | Stuks: 10 |  | <b>124-65926</b> | Stuks: 10 |  | <b>154-65926</b> | Stuks: 10 |
|  | <b>157-65926</b> | Stuks: 10 |  | <b>161-65926</b> | Stuks: 10 |  | <b>200-65926</b> | Stuks: 10 |
|  | <b>220-65926</b> | Stuks: 10 |  | <b>221-65926</b> | Stuks: 10 |   |                  |           |

D.1

D.2

D.3

D.4

D.5

D.6



Afdekplaten afzonderlijk te bestellen.  
Afbeldingen afgewerkte producten louter ter illustratie.



De meest recente informatie  
vind je op [www.niko.eu](http://www.niko.eu)



**Draaischakelaar voor motoren, drie snelheden (0-1-2 en 1-2-3), 20 A**

- centerafstand: 71 mm

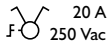

**SOKKEL**



**170-45901** Stuks: 10

Met schroefklemmen, voor schroefbevestiging

**AFWERKINGSSET (1-2-3)**



**100-65936** Stuks: 10  
**102-65936** Stuks: 10  
**122-65936** Stuks: 10  
**154-65936** Stuks: 10  
**200-65936** Stuks: 10

**101-65936** Stuks: 10  
**104-65936** Stuks: 10  
**123-65936** Stuks: 10  
**157-65936** Stuks: 10  
**220-65936** Stuks: 10

**111-65936** Stuks: 10  
**121-65936** Stuks: 10  
**124-65936** Stuks: 10  
**161-65936** Stuks: 10  
**221-65936** Stuks: 10

**AFWERKINGSSET (0-1-2)**



**100-65937** Stuks: 10  
**102-65937** Stuks: 10  
**122-65937** Stuks: 10  
**154-65937** Stuks: 10  
**200-65937** Stuks: 10

**101-65937** Stuks: 10  
**104-65937** Stuks: 10  
**123-65937** Stuks: 10  
**157-65937** Stuks: 10  
**220-65937** Stuks: 10

**111-65937** Stuks: 10  
**121-65937** Stuks: 10  
**124-65937** Stuks: 10  
**161-65937** Stuks: 10  
**221-65937** Stuks: 10



**Draaischakelaar voor motoren, drie snelheden (1-0-2), 25 A**

Ook geschikt voor rolluiken als de afwerkingsset 1XX-65926 gebruikt wordt.

- centerafstand: 71 mm

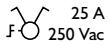

**SOKKEL**



**170-55901** Stuks: 10

Met schroefklemmen, voor schroefbevestiging

**AFWERKINGSSET (UP/DOWN)**



**100-65926** Stuks: 10  
**104-65926** Stuks: 10  
**123-65926** Stuks: 10  
**157-65926** Stuks: 10  
**220-65926** Stuks: 10

**101-65926** Stuks: 10  
**121-65926** Stuks: 10  
**124-65926** Stuks: 10  
**161-65926** Stuks: 10  
**221-65926** Stuks: 10

**102-65926** Stuks: 10  
**122-65926** Stuks: 10  
**154-65926** Stuks: 10  
**200-65926** Stuks: 10

**AFWERKINGSSET (1-0-2)**



**100-65938** Stuks: 10  
**102-65938** Stuks: 10  
**122-65938** Stuks: 10  
**154-65938** Stuks: 10  
**200-65938** Stuks: 10

**101-65938** Stuks: 10  
**104-65938** Stuks: 10  
**123-65938** Stuks: 10  
**157-65938** Stuks: 10  
**220-65938** Stuks: 10

**111-65938** Stuks: 10  
**121-65938** Stuks: 10  
**124-65938** Stuks: 10  
**161-65938** Stuks: 10  
**221-65938** Stuks: 10



Afdeklatten afzonderlijk te bestellen.  
 Afbeeldingen afgewerkte producten louter ter illustratie.

**Drukknop met drie aansluitklemmen, NO**

- centerafstand: 71 mm

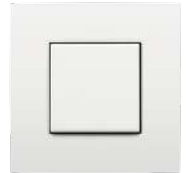

10 A  
250 Vac















**SOKKEL**

**170-70015** Stuks: 10 Met insteekklemmen, voor schroefbevestiging

















**170-70001** Stuks: 10 Met schroefklemmen, voor schroefbevestiging















**AFWERKINGSSET**

|   |                  |           |   |                  |           |   |                  |           |
|---|------------------|-----------|---|------------------|-----------|---|------------------|-----------|
|  | <b>100-61105</b> | Stuks: 20 |  | <b>101-61105</b> | Stuks: 20 |  | <b>111-61105</b> | Stuks: 20 |
|  | <b>102-61105</b> | Stuks: 20 |  | <b>104-61105</b> | Stuks: 20 |  | <b>121-61105</b> | Stuks: 10 |
|  | <b>122-61105</b> | Stuks: 10 |  | <b>123-61105</b> | Stuks: 10 |  | <b>124-61105</b> | Stuks: 10 |
|  | <b>154-61105</b> | Stuks: 10 |  | <b>157-61105</b> | Stuks: 10 |  | <b>161-61105</b> | Stuks: 10 |
|  | <b>200-61105</b> | Stuks: 10 |  | <b>220-61105</b> | Stuks: 10 |  | <b>221-61105</b> | Stuks: 10 |

**AFWERKINGSSET MET TRANSPARANT TEKSTVELD**

|   |                  |           |   |                  |           |  |                  |           |
|---|------------------|-----------|---|------------------|-----------|--|------------------|-----------|
|    | <b>100-60905</b> | Stuks: 20 |    | <b>101-60905</b> | Stuks: 20 |   | <b>102-60905</b> | Stuks: 20 |
|    | <b>104-60905</b> | Stuks: 20 |    | <b>121-60905</b> | Stuks: 10 |   | <b>122-60905</b> | Stuks: 10 |
|    | <b>123-60905</b> | Stuks: 10 |    | <b>124-60905</b> | Stuks: 10 |   | <b>154-60905</b> | Stuks: 10 |
|   | <b>157-60905</b> | Stuks: 10 |   | <b>161-60905</b> | Stuks: 10 |  | <b>200-60905</b> | Stuks: 10 |
|  | <b>220-60905</b> | Stuks: 10 |  | <b>221-60905</b> | Stuks: 10 |  |                  |           |

**AFWERKINGSSET MET TRANSPARANT VENSTERTJE (ZIE ACCESSOIRES VOOR LEDVERLICHTINGSELEMENTEN)**

|   |                  |           |   |                  |           |   |                  |           |
|---|------------------|-----------|---|------------------|-----------|---|------------------|-----------|
|  | <b>100-60005</b> | Stuks: 20 |  | <b>101-60005</b> | Stuks: 20 |  | <b>102-60005</b> | Stuks: 20 |
|  | <b>104-60005</b> | Stuks: 20 |  | <b>121-60005</b> | Stuks: 10 |  | <b>122-60005</b> | Stuks: 10 |
|  | <b>123-60005</b> | Stuks: 10 |  | <b>124-60005</b> | Stuks: 10 |  | <b>154-60005</b> | Stuks: 10 |
|  | <b>157-60005</b> | Stuks: 10 |  | <b>161-60005</b> | Stuks: 10 |  | <b>200-60005</b> | Stuks: 10 |
|  | <b>220-60005</b> | Stuks: 10 |  | <b>221-60005</b> | Stuks: 10 |   |                  |           |

D.1

D.2

D.3

D.4

D.5

D.6



Afdeklatten afzonderlijk te bestellen.  
Afbeeldingen afgewerkte producten louter ter illustratie.



De meest recente informatie  
vind je op [www.niko.eu](http://www.niko.eu)

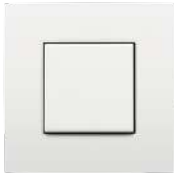

**Drukknop met vier aansluitklemmen, NO of NG**

- centerafstand: 71 mm



**SOKKEL**



**170-73015** Stuks: 10 Met insteekklemmen, voor schroefbevestiging



**170-73001** Stuks: 10 Met schroefklemmen, voor schroefbevestiging

**AFWERKINGSSET**



|  |                  |           |  |                  |           |  |                  |           |
|--|------------------|-----------|--|------------------|-----------|--|------------------|-----------|
|  | <b>100-61105</b> | Stuks: 20 |  | <b>101-61105</b> | Stuks: 20 |  | <b>111-61105</b> | Stuks: 20 |
|  | <b>102-61105</b> | Stuks: 20 |  | <b>104-61105</b> | Stuks: 20 |  | <b>121-61105</b> | Stuks: 10 |
|  | <b>122-61105</b> | Stuks: 10 |  | <b>123-61105</b> | Stuks: 10 |  | <b>124-61105</b> | Stuks: 10 |
|  | <b>154-61105</b> | Stuks: 10 |  | <b>157-61105</b> | Stuks: 10 |  | <b>161-61105</b> | Stuks: 10 |
|  | <b>200-61105</b> | Stuks: 10 |  | <b>220-61105</b> | Stuks: 10 |  | <b>221-61105</b> | Stuks: 10 |

**AFWERKINGSSET MET TRANSPARANT TEKSTVELD**



|  |                  |           |  |                  |           |  |                  |           |
|--|------------------|-----------|--|------------------|-----------|--|------------------|-----------|
|  | <b>100-60905</b> | Stuks: 20 |  | <b>101-60905</b> | Stuks: 20 |  | <b>102-60905</b> | Stuks: 20 |
|  | <b>104-60905</b> | Stuks: 20 |  | <b>121-60905</b> | Stuks: 10 |  | <b>122-60905</b> | Stuks: 10 |
|  | <b>123-60905</b> | Stuks: 10 |  | <b>124-60905</b> | Stuks: 10 |  | <b>154-60905</b> | Stuks: 10 |
|  | <b>157-60905</b> | Stuks: 10 |  | <b>161-60905</b> | Stuks: 10 |  | <b>200-60905</b> | Stuks: 10 |
|  | <b>220-60905</b> | Stuks: 10 |  | <b>221-60905</b> | Stuks: 10 |  |                  |           |

**AFWERKINGSSET MET TRANSPARANT VENSTERTJE (ZIE ACCESSOIRES VOOR LEDVERLICHTINGSELEMENTEN)**



|  |                  |           |  |                  |           |  |                  |           |
|--|------------------|-----------|--|------------------|-----------|--|------------------|-----------|
|  | <b>100-60005</b> | Stuks: 20 |  | <b>101-60005</b> | Stuks: 20 |  | <b>102-60005</b> | Stuks: 20 |
|  | <b>104-60005</b> | Stuks: 20 |  | <b>121-60005</b> | Stuks: 10 |  | <b>122-60005</b> | Stuks: 10 |
|  | <b>123-60005</b> | Stuks: 10 |  | <b>124-60005</b> | Stuks: 10 |  | <b>154-60005</b> | Stuks: 10 |
|  | <b>157-60005</b> | Stuks: 10 |  | <b>161-60005</b> | Stuks: 10 |  | <b>200-60005</b> | Stuks: 10 |
|  | <b>220-60005</b> | Stuks: 10 |  | <b>221-60005</b> | Stuks: 10 |  |                  |           |



Afdeklatten afzonderlijk te bestellen.  
Afbeeldingen afgewerkte producten louter ter illustratie.



**Tweevoudige drukknop, NO of NG**

- centerafstand: 71 mm

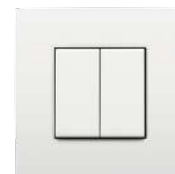

10 A  
250 Vac

**SOKKEL**

**170-75015** Stuks: 10 Met insteekklemmen, voor schroefbevestiging



**170-75001** Stuks: 10 Met schroefklemmen, voor schroefbevestiging

**AFWERKINGSSET**

|  |                  |           |  |                  |           |  |                  |           |
|--|------------------|-----------|--|------------------|-----------|--|------------------|-----------|
|  | <b>100-61505</b> | Stuks: 20 |  | <b>101-61505</b> | Stuks: 20 |  | <b>111-61505</b> | Stuks: 20 |
|  | <b>102-61505</b> | Stuks: 20 |  | <b>104-61505</b> | Stuks: 20 |  | <b>121-61505</b> | Stuks: 10 |
|  | <b>122-61505</b> | Stuks: 10 |  | <b>123-61505</b> | Stuks: 10 |  | <b>124-61505</b> | Stuks: 10 |
|  | <b>154-61505</b> | Stuks: 10 |  | <b>157-61505</b> | Stuks: 10 |  | <b>161-61505</b> | Stuks: 10 |
|  | <b>200-61505</b> | Stuks: 10 |  | <b>220-61505</b> | Stuks: 10 |  | <b>221-61505</b> | Stuks: 10 |

**AFWERKINGSSET MET TWEE TRANSPARANTE VENSTERTJES (ZIE ACCESSOIRES VOOR LEDVERLICHTINGSELEMENTEN)**

|  |                  |           |  |                  |           |  |                  |           |
|--|------------------|-----------|--|------------------|-----------|--|------------------|-----------|
|  | <b>100-61507</b> | Stuks: 20 |  | <b>101-61507</b> | Stuks: 20 |  | <b>102-61507</b> | Stuks: 20 |
|  | <b>104-61507</b> | Stuks: 20 |  | <b>121-61507</b> | Stuks: 10 |  | <b>122-61507</b> | Stuks: 10 |
|  | <b>123-61507</b> | Stuks: 10 |  | <b>124-61507</b> | Stuks: 10 |  | <b>154-61507</b> | Stuks: 10 |
|  | <b>157-61507</b> | Stuks: 10 |  | <b>161-61507</b> | Stuks: 10 |  | <b>200-61507</b> | Stuks: 10 |
|  | <b>220-61507</b> | Stuks: 10 |  | <b>221-61507</b> | Stuks: 10 |  |                  |           |

D.1

D.2

D.3

D.4

D.5

D.6



Afdeklatten afzonderlijk te bestellen.  
Afbeeldingen afgewerkte producten louter ter illustratie.



De meest recente informatie  
vind je op [www.niko.eu](http://www.niko.eu)



**Drukknop 6 A met E10-lamp met amberkleurige led**

Deze drukknop is voorzien van een E10-lamp met amberkleurige 230 Vac-led. Zie accessoires voor andere ledkleuren. De drukknop is:  
 - geschikt voor neonlampen van 230 V of ledlampen van 6 V, 12 V, 24 V en 230 V met een E10-lampvoet.  
 - niet geschikt voor gloeilampen met een E10-lampvoet.

- centerafstand: 71 mm

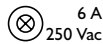

**SOKKEL**

















**170-74001** Stuks: 10

Met schroefklemmen, voor schroefbevestiging















**AFWERKINGSSET MET TRANSPARANTE RING**



|   |                  |           |   |                  |           |   |                  |           |
|---|------------------|-----------|---|------------------|-----------|---|------------------|-----------|
|  | <b>100-64006</b> | Stuks: 20 |  | <b>101-64006</b> | Stuks: 20 |  | <b>102-64006</b> | Stuks: 20 |
|  | <b>104-64006</b> | Stuks: 20 |  | <b>121-64006</b> | Stuks: 10 |  | <b>122-64006</b> | Stuks: 10 |
|  | <b>123-64006</b> | Stuks: 10 |  | <b>124-64006</b> | Stuks: 10 |  | <b>154-64006</b> | Stuks: 10 |
|  | <b>157-64006</b> | Stuks: 10 |  | <b>161-64006</b> | Stuks: 10 |  | <b>200-64006</b> | Stuks: 10 |
|  | <b>220-64006</b> | Stuks: 10 |  | <b>221-64006</b> | Stuks: 10 |   |                  |           |















**AFWERKINGSSET MET TRANSPARANTE RING EN BELSYMBOOL**



|   |                  |           |   |                  |           |   |                  |           |
|---|------------------|-----------|---|------------------|-----------|---|------------------|-----------|
|    | <b>100-64007</b> | Stuks: 20 |    | <b>101-64007</b> | Stuks: 20 |    | <b>102-64007</b> | Stuks: 20 |
|    | <b>104-64007</b> | Stuks: 20 |    | <b>121-64007</b> | Stuks: 10 |    | <b>122-64007</b> | Stuks: 10 |
|   | <b>123-64007</b> | Stuks: 10 |   | <b>124-64007</b> | Stuks: 10 |   | <b>154-64007</b> | Stuks: 10 |
|  | <b>157-64007</b> | Stuks: 10 |  | <b>161-64007</b> | Stuks: 10 |  | <b>200-64007</b> | Stuks: 10 |
|  | <b>220-64007</b> | Stuks: 10 |  | <b>221-64007</b> | Stuks: 10 |   |                  |           |















**AFWERKINGSSET MET TRANSPARANTE RING EN LAMPSYMBOL**



|   |                  |           |   |                  |           |   |                  |           |
|---|------------------|-----------|---|------------------|-----------|---|------------------|-----------|
|  | <b>100-64008</b> | Stuks: 20 |  | <b>101-64008</b> | Stuks: 20 |  | <b>102-64008</b> | Stuks: 20 |
|  | <b>104-64008</b> | Stuks: 20 |  | <b>121-64008</b> | Stuks: 10 |  | <b>122-64008</b> | Stuks: 10 |
|  | <b>123-64008</b> | Stuks: 10 |  | <b>124-64008</b> | Stuks: 10 |  | <b>154-64008</b> | Stuks: 10 |
|  | <b>157-64008</b> | Stuks: 10 |  | <b>161-64008</b> | Stuks: 10 |  | <b>200-64008</b> | Stuks: 10 |
|  | <b>220-64008</b> | Stuks: 10 |  | <b>221-64008</b> | Stuks: 10 |   |                  |           |

**AFWERKINGSSET MET TRANSPARANTE RING EN SLEUTELSYMBOOL**



|   |                  |           |   |                  |           |   |                  |           |
|---|------------------|-----------|---|------------------|-----------|---|------------------|-----------|
|  | <b>100-64009</b> | Stuks: 20 |  | <b>101-64009</b> | Stuks: 20 |  | <b>102-64009</b> | Stuks: 20 |
|  | <b>104-64009</b> | Stuks: 20 |  | <b>121-64009</b> | Stuks: 10 |  | <b>122-64009</b> | Stuks: 10 |
|  | <b>123-64009</b> | Stuks: 10 |  | <b>124-64009</b> | Stuks: 10 |  | <b>154-64009</b> | Stuks: 10 |
|  | <b>157-64009</b> | Stuks: 10 |  | <b>161-64009</b> | Stuks: 10 |  | <b>200-64009</b> | Stuks: 10 |
|  | <b>220-64009</b> | Stuks: 10 |  | <b>221-64009</b> | Stuks: 10 |   |                  |           |



Afdekplaten afzonderlijk te bestellen.  
 Afbeeldingen afgewerkte producten louter ter illustratie.

**Viervoudige potentiaalvrije 24V-drukknop, NO**

• centerafstand: 71 mm

**SOKKEL****170-47051**

Stuks: 6

Met schroefklemmen, voor schroefbevestiging

**AFWERKINGSSET**

|  |                  |          |  |                  |          |  |                  |          |
|--|------------------|----------|--|------------------|----------|--|------------------|----------|
|  | <b>100-40050</b> | Stuks: 6 |  | <b>101-40050</b> | Stuks: 6 |  | <b>102-40050</b> | Stuks: 6 |
|  | <b>104-40050</b> | Stuks: 6 |  | <b>121-40050</b> | Stuks: 6 |  | <b>122-40050</b> | Stuks: 6 |
|  | <b>123-40050</b> | Stuks: 6 |  | <b>124-40050</b> | Stuks: 6 |  | <b>154-40050</b> | Stuks: 6 |
|  | <b>157-40050</b> | Stuks: 6 |  | <b>161-40050</b> | Stuks: 6 |  | <b>200-40050</b> | Stuks: 6 |
|  | <b>220-40050</b> | Stuks: 6 |  | <b>221-40050</b> | Stuks: 6 |  |                  |          |

**AFWERKINGSSET MET TEKSTVELD**

|  |                  |          |  |                  |          |  |                  |          |
|--|------------------|----------|--|------------------|----------|--|------------------|----------|
|  | <b>100-40250</b> | Stuks: 6 |  | <b>101-40250</b> | Stuks: 6 |  | <b>102-40250</b> | Stuks: 6 |
|  | <b>104-40250</b> | Stuks: 6 |  | <b>121-40250</b> | Stuks: 6 |  | <b>122-40250</b> | Stuks: 6 |
|  | <b>123-40250</b> | Stuks: 6 |  | <b>124-40250</b> | Stuks: 6 |  | <b>154-40250</b> | Stuks: 6 |
|  | <b>157-40250</b> | Stuks: 6 |  | <b>161-40250</b> | Stuks: 6 |  | <b>200-40250</b> | Stuks: 6 |
|  | <b>220-40250</b> | Stuks: 6 |  | <b>221-40250</b> | Stuks: 6 |  |                  |          |

**Viervoudige potentiaalvrije 24V-drukknop met leds, NO**

• centerafstand: 71 mm

**SOKKEL MET AMBERKLEURIGE LEDS****170-47151**

Stuks: 6

Met schroefklemmen, voor schroefbevestiging

**SOKKEL MET BLAUWE LEDS****170-47161**

Stuks: 6

Met schroefklemmen, voor schroefbevestiging

**SOKKEL MET WITTE LEDS****NIEUW****170-47171**

Stuks: 6

Met schroefklemmen, voor schroefbevestiging

**AFWERKINGSSET**

|  |                  |          |  |                  |          |  |                  |          |
|--|------------------|----------|--|------------------|----------|--|------------------|----------|
|  | <b>100-40150</b> | Stuks: 6 |  | <b>101-40150</b> | Stuks: 6 |  | <b>102-40150</b> | Stuks: 6 |
|  | <b>104-40150</b> | Stuks: 6 |  | <b>121-40150</b> | Stuks: 6 |  | <b>122-40150</b> | Stuks: 6 |
|  | <b>123-40150</b> | Stuks: 6 |  | <b>124-40150</b> | Stuks: 6 |  | <b>154-40150</b> | Stuks: 6 |
|  | <b>157-40150</b> | Stuks: 6 |  | <b>161-40150</b> | Stuks: 6 |  | <b>200-40150</b> | Stuks: 6 |
|  | <b>220-40150</b> | Stuks: 6 |  | <b>221-40150</b> | Stuks: 6 |  |                  |          |

**AFWERKINGSSET MET TRANSPARANT TEKSTVELD**

|  |                  |          |  |                  |          |  |                  |          |
|--|------------------|----------|--|------------------|----------|--|------------------|----------|
|  | <b>100-40350</b> | Stuks: 6 |  | <b>101-40350</b> | Stuks: 6 |  | <b>102-40350</b> | Stuks: 6 |
|  | <b>104-40350</b> | Stuks: 6 |  | <b>121-40350</b> | Stuks: 6 |  | <b>122-40350</b> | Stuks: 6 |
|  | <b>123-40350</b> | Stuks: 6 |  | <b>124-40350</b> | Stuks: 6 |  | <b>154-40350</b> | Stuks: 6 |
|  | <b>157-40350</b> | Stuks: 6 |  | <b>161-40350</b> | Stuks: 6 |  | <b>200-40350</b> | Stuks: 6 |
|  | <b>220-40350</b> | Stuks: 6 |  | <b>221-40350</b> | Stuks: 6 |  |                  |          |



Afdeklatten afzonderlijk te bestellen.  
Afbeeldingen afgewerkte producten louter ter illustratie.



De meest recente informatie  
vind je op [www.niko.eu](http://www.niko.eu)

D.1

D.2

D.3

D.4

D.5

D.6



**Zesvoudige potentiaalvrije 24V-drukknop, NO**

- centerafstand: 71 mm



**SOKKEL**



**170-67051** Stuks: 6

Met schroefklemmen, voor schroefbevestiging

**AFWERKINGSSET**



- 100-60050** Stuks: 6
- 104-60050** Stuks: 6
- 123-60050** Stuks: 6
- 157-60050** Stuks: 6
- 220-60050** Stuks: 6

- 101-60050** Stuks: 6
- 121-60050** Stuks: 6
- 124-60050** Stuks: 6
- 161-60050** Stuks: 6
- 221-60050** Stuks: 6

- 102-60050** Stuks: 6
- 122-60050** Stuks: 6
- 154-60050** Stuks: 6
- 200-60050** Stuks: 6



**Zesvoudige potentiaalvrije 24V-drukknop met LEDs, NO**

- centerafstand: 71 mm



**SOKKEL MET AMBERKLEURIGE LEDS**



**170-67151** Stuks: 6

Met schroefklemmen, voor schroefbevestiging

**SOKKEL MET BLAUWE LEDS**



**170-67161** Stuks: 6

Met schroefklemmen, voor schroefbevestiging

**SOKKEL MET WITTE LEDS**



**NIEUW** **170-67171** Stuks: 6

Met schroefklemmen, voor schroefbevestiging



- 100-60150** Stuks: 6
- 104-60150** Stuks: 6
- 123-60150** Stuks: 6
- 157-60150** Stuks: 6
- 220-60150** Stuks: 6

- 101-60150** Stuks: 6
- 121-60150** Stuks: 6
- 124-60150** Stuks: 6
- 161-60150** Stuks: 6
- 221-60150** Stuks: 6

- 102-60150** Stuks: 6
- 122-60150** Stuks: 6
- 154-60150** Stuks: 6
- 200-60150** Stuks: 6

















**Elektronische thermostaat**

Tweepuntsregelaar voor de centrale verwarming, elektrische verwarming of airconditioning.

- voedingsspanning: 230 Vac, 50 Hz
- twee werkingmodes: verwarming en airconditioning
- driestandenschakelaar: aan (dagregeling), eco (nachtregeling) en uit (stand-by)
- regelbereik: 5 - 30 °C (instelbaar)
- instelprecisie:  $\pm 1$  °C
- hysteresis: 1 °C
- montagehoogte: 1,5 m
- wisselcontact: 8 A (potentiaalvrij)

**VOLLEDIG APPARAAT VOOR SCHROEFBEVESTIGING**

|   |                  |          |   |                  |          |   |                  |          |
|---|------------------|----------|---|------------------|----------|---|------------------|----------|
|  | <b>100-88001</b> | Stuks: 6 |  | <b>101-88001</b> | Stuks: 6 |  | <b>102-88001</b> | Stuks: 6 |
|  | <b>104-88001</b> | Stuks: 6 |  | <b>121-88001</b> | Stuks: 6 |  | <b>122-88001</b> | Stuks: 6 |
|  | <b>123-88001</b> | Stuks: 6 |  | <b>124-88001</b> | Stuks: 6 |  | <b>154-88001</b> | Stuks: 6 |
|  | <b>157-88001</b> | Stuks: 6 |  | <b>161-88001</b> | Stuks: 6 |  | <b>200-88001</b> | Stuks: 6 |
|  | <b>220-88001</b> | Stuks: 6 |  | <b>221-88001</b> | Stuks: 6 |   |                  |          |















**Snelheidsregelaar voor motoren (ventilatie)**

- uitsluitend voor gebruik met elektronische voorbelasting 09-016-10
- ingebouwde wisselchakelaar
- voedingsspanning: 230 Vac  $\pm$  10%, 40 - 60 Hz
- maximale belasting: 200 VA
- minimale belasting: 20 W
- minimaal toerental instelbaar
- thermische overbelastingsbeveiliging zonder herstelfunctie
- kortsluitbeveiliging via zekering (F 3,15 AH)
- ingebouwde reservezekering
- aansluitklemmen: 2 x 1,5 mm<sup>2</sup> of 1 x 2,5 mm<sup>2</sup>
- omgevingstemperatuur: 20 °C

**SOKKEL**

**310-01801** Stuks: 6 Met schroefklemmen, voor schroefbevestiging

**AFWERKINGSSET**

|   |                  |           |   |                  |           |   |                  |           |
|---|------------------|-----------|---|------------------|-----------|---|------------------|-----------|
|  | <b>100-31000</b> | Stuks: 10 |  | <b>101-31000</b> | Stuks: 10 |  | <b>111-31000</b> | Stuks: 10 |
|  | <b>102-31000</b> | Stuks: 10 |  | <b>104-31000</b> | Stuks: 10 |  | <b>121-31000</b> | Stuks: 10 |
|  | <b>122-31000</b> | Stuks: 10 |  | <b>123-31000</b> | Stuks: 10 |  | <b>124-31000</b> | Stuks: 10 |
|  | <b>154-31000</b> | Stuks: 10 |  | <b>157-31000</b> | Stuks: 10 |  | <b>161-31000</b> | Stuks: 10 |
|  | <b>200-31000</b> | Stuks: 10 |  | <b>220-31000</b> | Stuks: 10 |  | <b>221-31000</b> | Stuks: 10 |

**ACCESSOIRES**

**310-00001** Stuks: 10 Zekeringhouder voor draaiknopdimmers

**ACCESSOIRES**

**09-016-10** Stuks: 6 Elektronische voorbelasting



Afdekkapen afzonderlijk te bestellen.  
Afbeldingen afgewerkte producten louter ter illustratie.



De meest recente informatie  
vind je op [www.niko.eu](http://www.niko.eu)

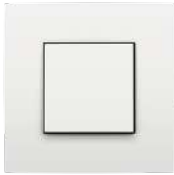

### Blindplaat

- centerafstand: 71 mm

#### SOKKEL













**170-68900** Stuks: 10





Voor schroefbevestiging

#### BLINDPLAATJES 45X45 MM



 **100-76901** Stuks: 10  
 **102-76901** Stuks: 10  
 **122-76901** Stuks: 10  
 **154-76901** Stuks: 10  
 **200-76901** Stuks: 10

 **101-76901** Stuks: 10  
 **104-76901** Stuks: 10  
 **123-76901** Stuks: 10  
 **157-76901** Stuks: 10  
 **220-76901** Stuks: 10

 **111-76901** Stuks: 10  
 **121-76901** Stuks: 10  
 **124-76901** Stuks: 10  
 **161-76901** Stuks: 10  
 **221-76901** Stuks: 10

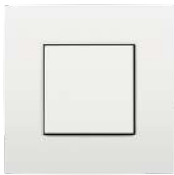

### Blindplaat met draadtrekontlasting

De afwerkingsset heeft een opening van 6,6 mm die kan worden vergroot tot 14,4 mm door de extra uitbreekvlakken te verwijderen.

- centerafstand: 71 mm

#### SOKKEL













**170-00900** Stuks: 10





Voor schroefbevestiging

#### AFWERKINGSSET MET KABELUITGANG



 **100-76001** Stuks: 10  
 **104-76001** Stuks: 10  
 **123-76001** Stuks: 10  
 **157-76001** Stuks: 10  
 **220-76001** Stuks: 10

 **101-76001** Stuks: 10  
 **121-76001** Stuks: 10  
 **124-76001** Stuks: 10  
 **161-76001** Stuks: 10  
 **221-76001** Stuks: 10

 **102-76001** Stuks: 10  
 **122-76001** Stuks: 10  
 **154-76001** Stuks: 10  
 **200-76001** Stuks: 10





## Ledverlichtingselementen

Het ledverlichtingselement met automatische aansluiting heeft een signalisatiefunctie in combinatie met een enkelpolige schakelaar, een wissel- of kruisschakelaar, een NO-drukknop of een NO- of NG-drukknop.





In combinatie met een tweepolige schakelaar heeft dit ledverlichtingselement met automatische aansluiting een controlefunctie.

### LEDVERLICHTINGSELEMENTEN SPECIFIEK VOOR SCHAKELAARS MET INSTEEKKLEMMEN (NIET VOOR NIKO HYDRO)

|  |              |                  |           |   |
|--|--------------|------------------|-----------|---|
|  | <b>NIEUW</b> | <b>170-77023</b> | Stuks: 10 | Met automatische aansluiting, wit, 230 Vac          |
|  |              | <b>170-77123</b> | Stuks: 10 | Met automatische aansluiting, blauw, 230 Vac        |
|  |              | <b>170-77323</b> | Stuks: 10 | Met automatische aansluiting, amberkleurig, 230 Vac |

### LEDVERLICHTINGSELEMENTEN SPECIFIEK VOOR SCHAKELAARS MET SCHROEFKLEMMEN

|  |              |                  |           |   |
|--|--------------|------------------|-----------|---|
|  | <b>NIEUW</b> | <b>170-37023</b> | Stuks: 10 | Met automatische aansluiting, wit, 230 Vac          |
|  |              | <b>170-37123</b> | Stuks: 10 | Met automatische aansluiting, blauw, 230 Vac        |
|  |              | <b>170-37323</b> | Stuks: 10 | Met automatische aansluiting, amberkleurig, 230 Vac |

### LEDVERLICHTINGSELEMENTEN

|  |              |                  |           |                                      |
|--|--------------|------------------|-----------|--------------------------------------|
|   | <b>NIEUW</b> | <b>170-37012</b> | Stuks: 10 | Met draden, wit, 12 Vac/Vdc          |
|  | <b>NIEUW</b> | <b>170-37024</b> | Stuks: 10 | Met draden, wit, 24 Vac/Vdc          |
|  | <b>NIEUW</b> | <b>170-37923</b> | Stuks: 10 | Met draden, wit, 230 Vac             |
|  |              | <b>170-37212</b> | Stuks: 10 | Met draden, blauw, 12 Vac/Vdc        |
|  |              | <b>170-37224</b> | Stuks: 10 | Met draden, blauw, 24 Vac/Vdc        |
|  |              | <b>170-37223</b> | Stuks: 10 | Met draden, blauw, 230 Vac           |
|  |              | <b>170-37424</b> | Stuks: 10 | Met draden, amberkleurig, 24 Vac/Vdc |
|  |              | <b>170-37423</b> | Stuks: 10 | Met draden, amberkleurig, 230 Vac    |
|  |              | <b>170-37623</b> | Stuks: 10 | Met draden, rood, 230 Vac            |
|  |              | <b>170-37823</b> | Stuks: 10 | Met draden, groen, 230 Vac           |

D.1

D.2

D.3

D.4

D.5

D.6



De meest recente informatie  
vind je op [www.niko.eu](http://www.niko.eu)



### E10-lampen voor 6A-druknoppen

#### ACCESSOIRES



**170-37001** Stuks: 10 Met amberkleurige 230 Vac-led



**170-37002** Stuks: 10 Met blauwe 230 Vac-led



**170-37003** Stuks: 10 Met rode 230 Vac-led

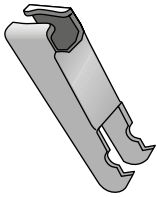

### Lange klauw

#### TOEBEHOREN



**170-71003** Stuks: 20 Voor schakelaars en wandcontactdozen met klauwen

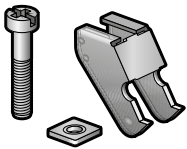

### Klauwen

Set met klauwen, schroeven en moeren om om te schakelen van schroefbevestiging naar klauwbevestiging. De set is geschikt voor 50 sokkels.

#### ACCESSOIRES



**170-71005** Stuks: 100 Voor schakelaars



**170-71006** Stuks: 100 Voor wandcontactdozen met schroefklemmen



**170-71008** Stuks: 100 Voor 45x45 mm-functies (RJ45, tv ...)

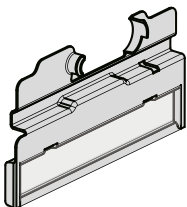

### Etikethouder

De etikethouder wordt gebruikt om onder meer schakelmateriaal te etiketteren. Het kan worden verplaatst en is combineerbaar met alle functies en de drie reeksen afdekplaten (Niko Original, Niko Intense en Niko Pure). De etikethouder kan links, rechts, onderaan of bovenaan worden geplaatst, en blijft hangen als de afdekplaat verwijderd is voor bijvoorbeeld schilderwerken of de schoonmaak.

- maximale afmetingen van etiket: 6 x 42 mm

- maximale lettergrootte: Arial 16 pt

#### ACCESSOIRES



**170-00096** Stuks: 50 Etikethouder



## Beschermkap voor schilderwerken

De beschermkap wordt altijd over een mechanisme geplaatst dat voorzien is van een afwerkingsset. Het is geschikt voor de Niko Original, Niko Pure en Niko Intense reeksen.



### ACCESSOIRES



**170-00099** Stuks: 100 Beschermkap voor schilderwerken

## Opbouwdozen

Deze opbouwdozen zijn geschikt voor alle inbouwapparaten uit de Niko Original reeks (behalve tijdschakelaars). Ze worden direct op de wand gemonteerd (schroeven bijgeleverd).

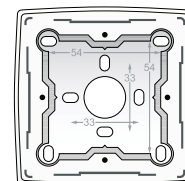

### ENKELVOUDIGE OPBOUWDOOS



**100-77100** Stuks: 10 cream



**101-77100** Stuks: 10 white



**102-77100** Stuks: 10 light grey

### TWEEVOUDIGE OPBOUWDOOS

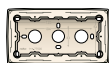

**100-77500** Stuks: 5 cream

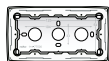

**101-77500** Stuks: 5 white

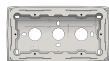

**102-77500** Stuks: 5 light grey

## Buisingen

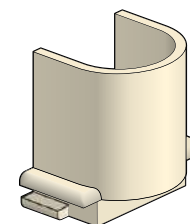

### M16-BUISINGANG



**11-865** Stuks: 50 cream



**31-865** Stuks: 50 white

### M20-BUISINGANG



**11-866** Stuks: 50 cream



**31-866** Stuks: 50 white



De meest recente informatie  
vind je op [www.niko.eu](http://www.niko.eu)

D.1

D.2

D.3

D.4

D.5

D.6

## Elektronische voorbelasting

De elektronische voorbelasting vervangt de klassieke ohmse belasting en kan gemakkelijk worden ingebouwd dankzij de uiterst compacte behuizing van hittebestendig, thermoplastisch materiaal. Het is veilig in alle inbouwomstandigheden dankzij een opwarming van slechts 35 °C boven de omgevingstemperatuur. De elektronische voorbelasting is tot 56% koeler dan normale oplossingen op basis van weerstanden (54% energiebesparing in vergelijking met de klassieke ohmse belasting). Het moet in parallel worden aangesloten op de primaire kring van de belasting.

- afmetingen: 65 x 48 x 28 mm (HxBxD)
- omgevingstemperatuur: max. 40 °C
- gewicht: 270 g

## ACCESSOIRES

**09-016-10**    Stuks: 6                    Elektronische voorbelasting

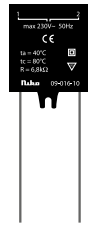





# Medianetwerk

## Overal toegang tot de wereld van multimedia

Een woning die altijd optimaal aangepast is aan elke fase van je levensloop en rekening houdt met je eigen levensstijl. Met het medianetwerk van Niko haal je hiervoor de geknipte mediaoplossing in huis.

### VOORDELEN



#### Web van mediafuncties

- totale flexibiliteit door ondersteuning van alle mediasignalen
- in elke kamer altijd de geschikte aansluiting
- onafhankelijk van de kabeloperator
- van functie veranderen is eenvoudig, zonder kap- of breekwerk

Coax en RJ45, cat. 5E of cat. 6, cat. 6A, UTP of STP



#### Eenvoudige installatie van RJ45 connectoren

- aansluiten zonder gereedschap
- connectoren bestaan uit 1 stuk, met beperkte diepte
- kabeltoevoer kan ook van bovenuit
- installatie in stervorm

#### Tijdloos design

- aansluitend bij Niko Pure, Niko Intense en Niko Original



### NIEUW

#### RJ45 dataconnectie cat. 6A

- voor veeleisende thuisnetwerken: 10.000 Mbit/s, 500 MHz, 10 Gb, max. 100 meter
- UTP of STP
- ook beschikbaar in een combinatie van coax en RJ45



D.1

D.2

D.3

D.4

D.5

D.6



De meest recente informatie  
vind je op [www.niko.eu](http://www.niko.eu)



### Audio met cinch-aansluiting

- centerafstand: 71 mm















#### SOKKEL



**170-68900** Stuks: 10 Voor schroefbevestiging















#### AFWERKINGSSET VOOR TWEEVOUDIGE CINCH-AANSLUITING



|   |                  |           |   |                  |           |   |                  |           |
|---|------------------|-----------|---|------------------|-----------|---|------------------|-----------|
|  | <b>100-69716</b> | Stuks: 10 |  | <b>101-69716</b> | Stuks: 10 |  | <b>102-69716</b> | Stuks: 10 |
|  | <b>104-69716</b> | Stuks: 10 |  | <b>121-69716</b> | Stuks: 10 |  | <b>122-69716</b> | Stuks: 10 |
|  | <b>123-69716</b> | Stuks: 10 |  | <b>124-69716</b> | Stuks: 10 |  | <b>154-69716</b> | Stuks: 10 |
|  | <b>157-69716</b> | Stuks: 10 |  | <b>161-69716</b> | Stuks: 10 |  | <b>200-69716</b> | Stuks: 10 |
|  | <b>220-69716</b> | Stuks: 10 |  | <b>221-69716</b> | Stuks: 10 |   |                  |           |

#### AFWERKINGSSET VOOR DRIEVOUDIGE CINCH-AANSLUITING



|   |                  |           |   |                  |           |   |                  |           |
|---|------------------|-----------|---|------------------|-----------|---|------------------|-----------|
|  | <b>100-69717</b> | Stuks: 10 |  | <b>101-69717</b> | Stuks: 10 |  | <b>102-69717</b> | Stuks: 10 |
|  | <b>104-69717</b> | Stuks: 10 |  | <b>121-69717</b> | Stuks: 10 |  | <b>122-69717</b> | Stuks: 10 |
|  | <b>123-69717</b> | Stuks: 10 |  | <b>124-69717</b> | Stuks: 10 |  | <b>154-69717</b> | Stuks: 10 |
|  | <b>157-69717</b> | Stuks: 10 |  | <b>161-69717</b> | Stuks: 10 |  | <b>200-69717</b> | Stuks: 10 |
|  | <b>220-69717</b> | Stuks: 10 |  | <b>221-69717</b> | Stuks: 10 |   |                  |           |



### Audio met xlr- of jack-aansluiting (neutrik)

Bevestigingsschroeven bijgeleverd bij de afwerkingsset.

- centerafstand: 71 mm















#### SOKKEL



**170-68900** Stuks: 10 Voor schroefbevestiging

#### AFWERKINGSSET



|   |                  |           |   |                  |           |   |                  |           |
|---|------------------|-----------|---|------------------|-----------|---|------------------|-----------|
|  | <b>100-69856</b> | Stuks: 10 |  | <b>101-69856</b> | Stuks: 10 |  | <b>102-69856</b> | Stuks: 10 |
|  | <b>104-69856</b> | Stuks: 10 |  | <b>121-69856</b> | Stuks: 10 |  | <b>122-69856</b> | Stuks: 10 |
|  | <b>123-69856</b> | Stuks: 10 |  | <b>124-69856</b> | Stuks: 10 |  | <b>154-69856</b> | Stuks: 10 |
|  | <b>157-69856</b> | Stuks: 10 |  | <b>161-69856</b> | Stuks: 10 |  | <b>200-69856</b> | Stuks: 10 |
|  | <b>220-69856</b> | Stuks: 10 |  | <b>221-69856</b> | Stuks: 10 |   |                  |           |

#### ACCESSOIRES



**170-39852** Stuks: 10 Vrouwelijke XLR-connector



**170-39853** Stuks: 10 Mannelijke XLR-connector



**170-39854** Stuks: 10 Jack-connector



Afdekplaten afzonderlijk te bestellen.  
Afbeeldingen afgewerkte producten louter ter illustratie.

## Enkelvoudige luidsprekeraansluiting

• maximale kabeldikte: 4 mm<sup>2</sup>

• centerafstand: 71 mm



## SOKKEL

**170-79801**

Stuks: 10

Met schroefklemmen, voor schroefbevestiging

## AFWERKINGSSET

**100-69801**

Stuks: 10

**102-69801**

Stuks: 10

**122-69801**

Stuks: 10

**154-69801**

Stuks: 10

**200-69801**

Stuks: 10

**101-69801**

Stuks: 10

**104-69801**

Stuks: 10

**123-69801**

Stuks: 10

**157-69801**

Stuks: 10

**220-69801**

Stuks: 10

**111-69801**

Stuks: 10

**121-69801**

Stuks: 10

**124-69801**

Stuks: 10

**161-69801**

Stuks: 10

**221-69801**

Stuks: 10

## Tweevoudige luidsprekeraansluiting

• maximale kabeldikte: 4 mm<sup>2</sup>

• centerafstand: 71 mm



## SOKKEL

**170-79701**

Stuks: 10

Met schroefklemmen, voor schroefbevestiging

## AFWERKINGSSET

**100-69701**

Stuks: 10

**104-69701**

Stuks: 10

**123-69701**

Stuks: 10

**157-69701**

Stuks: 10

**220-69701**

Stuks: 10

**101-69701**

Stuks: 10

**121-69701**

Stuks: 10

**124-69701**

Stuks: 10

**161-69701**

Stuks: 10

**221-69701**

Stuks: 10

**102-69701**

Stuks: 10

**122-69701**

Stuks: 10

**154-69701**

Stuks: 10

**200-69701**

Stuks: 10

D.1

D.2

D.3

D.4

D.5

D.6



Afdeklatten afzonderlijk te bestellen.  
Afbeeldingen afgewerkte producten louter ter illustratie.



De meest recente informatie  
vind je op [www.niko.eu](http://www.niko.eu)

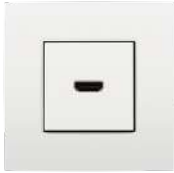

**HDMI-aansluiting**

Om HDMI-kabels weg te werken in de muur, een tv-meubel of kantoormeubel. In een meubel of valse wand zonder wachtbuis worden twee contactdozen met HDMI-naar-HDMI-aansluiting gebruikt om de kabel te verbinden. Als er een lege buis voorzien is (bijvoorbeeld bij een gemetselde muur), wordt de HDMI-connector aan de ene kant aangesloten op een contactdoos met HDMI-naar-HDMI-aansluiting, en aan de andere kant afgeknipt, door de lege buis getrokken en bevestigd aan de schroefconnector van de contactdoos met HDMI-naar-schroefaansluiting.

- montage: inbouwdoos met inbouwdiepte van minimaal 60 mm
- kabel: met haakse HDMI-connector
- HDMI-aansluiting: type A, vrouwelijk
- schroefaansluiting: afneembare schroefconnector, 2 x 10 aansluitklemmen
- kabelhulzen en warmtekrimpkous bijgeleverd















**SOKKEL**



**170-68900** Stuks: 10 Voor schroefbevestiging















**AFWERKINGSSET MET HDMI-NAAR-SCHROEFAANSLUITING**



|   |                  |           |   |                  |           |   |                  |           |
|---|------------------|-----------|---|------------------|-----------|---|------------------|-----------|
|  | <b>100-69416</b> | Stuks: 10 |  | <b>101-69416</b> | Stuks: 10 |  | <b>102-69416</b> | Stuks: 10 |
|  | <b>104-69416</b> | Stuks: 10 |  | <b>121-69416</b> | Stuks: 10 |  | <b>122-69416</b> | Stuks: 10 |
|  | <b>123-69416</b> | Stuks: 10 |  | <b>124-69416</b> | Stuks: 10 |  | <b>154-69416</b> | Stuks: 10 |
|  | <b>157-69416</b> | Stuks: 10 |  | <b>161-69416</b> | Stuks: 10 |  | <b>200-69416</b> | Stuks: 10 |
|  | <b>220-69416</b> | Stuks: 10 |  | <b>221-69416</b> | Stuks: 10 |   |                  |           |

**AFWERKINGSSET MET HDMI-NAAR-HDMI-AANSLUITING**



|   |                  |           |   |                  |           |   |                  |           |
|---|------------------|-----------|---|------------------|-----------|---|------------------|-----------|
|    | <b>100-69417</b> | Stuks: 10 |    | <b>101-69417</b> | Stuks: 10 |    | <b>102-69417</b> | Stuks: 10 |
|   | <b>104-69417</b> | Stuks: 10 |   | <b>121-69417</b> | Stuks: 10 |   | <b>122-69417</b> | Stuks: 10 |
|  | <b>123-69417</b> | Stuks: 10 |  | <b>124-69417</b> | Stuks: 10 |  | <b>154-69417</b> | Stuks: 10 |
|  | <b>157-69417</b> | Stuks: 10 |  | <b>161-69417</b> | Stuks: 10 |  | <b>200-69417</b> | Stuks: 10 |
|  | <b>220-69417</b> | Stuks: 10 |  | <b>221-69417</b> | Stuks: 10 |   |                  |           |



**Enkelvoudige mannelijke coaxaansluiting**

DIN 45325, IEC 60169-2  
aansluitdemping < 1 dB















**SOKKEL**



**170-09121** Stuks: 10 Met schroefklemmen en schroefbevestiging

**AFWERKINGSSET**



|   |                  |           |   |                  |           |   |                  |           |
|---|------------------|-----------|---|------------------|-----------|---|------------------|-----------|
|  | <b>100-69101</b> | Stuks: 10 |  | <b>101-69101</b> | Stuks: 10 |  | <b>102-69101</b> | Stuks: 10 |
|  | <b>104-69101</b> | Stuks: 10 |  | <b>121-69101</b> | Stuks: 10 |  | <b>122-69101</b> | Stuks: 10 |
|  | <b>123-69101</b> | Stuks: 10 |  | <b>124-69101</b> | Stuks: 10 |  | <b>154-69101</b> | Stuks: 10 |
|  | <b>157-69101</b> | Stuks: 10 |  | <b>161-69101</b> | Stuks: 10 |  | <b>200-69101</b> | Stuks: 10 |
|  | <b>220-69101</b> | Stuks: 10 |  | <b>221-69101</b> | Stuks: 10 |   |                  |           |

**DIN-RAIL CONNECTOR (INCL. DIN-RAIL ADAPTER EN CONNECTOR TV)**



**650-16900** Stuks: 10 DIN-rail coax F-connector TV (voor RG59 kabel)





**Coxaansluiting EDU TV + FM**















DIN 45325, IEC 60169-2

aansluitdemping tv &lt; 1 dB; FM &lt; 3 dB

**SOKKEL**

**170-79501** Stuks: 10 Met schroefklemmen en schroefbevestiging, centerafstand 71 mm

**AFWERKINGSSET**

|   |                  |           |   |                  |           |   |                  |           |
|---|------------------|-----------|---|------------------|-----------|---|------------------|-----------|
|  | <b>100-69702</b> | Stuks: 10 |  | <b>101-69702</b> | Stuks: 10 |  | <b>111-69702</b> | Stuks: 10 |
|  | <b>102-69702</b> | Stuks: 10 |  | <b>104-69702</b> | Stuks: 10 |  | <b>121-69702</b> | Stuks: 10 |
|  | <b>122-69702</b> | Stuks: 10 |  | <b>123-69702</b> | Stuks: 10 |  | <b>124-69702</b> | Stuks: 10 |
|  | <b>154-69702</b> | Stuks: 10 |  | <b>157-69702</b> | Stuks: 10 |  | <b>161-69702</b> | Stuks: 10 |
|  | <b>200-69702</b> | Stuks: 10 |  | <b>220-69702</b> | Stuks: 10 |  | <b>221-69702</b> | Stuks: 10 |

**DIN-RAIL CONNECTOR (INCL. DIN-RAIL ADAPTER EN CONNECTOR TV)**

**650-16900** Stuks: 10 DIN-rail coax F-connector TV (voor RG59 kabel)

**Coxaansluiting TV + FM + satelliet**

DIN 45325, IEC 60169-2

aansluitdemping tv &lt; 1 dB (5-80MHz); 1,5 dB ±1 dB (125-860 MHz)















aansluitdemping FM &lt; 3 dB (88-108 MHz)

aansluitdemping satelliet: 2,5 dB ±1 dB

**SOKKEL**

**170-79551** Stuks: 10 Met schroefklemmen en schroefbevestiging, centerafstand 71 mm

**AFWERKINGSSET**

|   |                  |           |   |                  |           |   |                  |           |
|---|------------------|-----------|---|------------------|-----------|---|------------------|-----------|
|  | <b>100-69551</b> | Stuks: 10 |  | <b>101-69551</b> | Stuks: 10 |  | <b>111-69551</b> | Stuks: 10 |
|  | <b>102-69551</b> | Stuks: 10 |  | <b>104-69551</b> | Stuks: 10 |  | <b>121-69551</b> | Stuks: 10 |
|  | <b>122-69551</b> | Stuks: 10 |  | <b>123-69551</b> | Stuks: 10 |  | <b>124-69551</b> | Stuks: 10 |
|  | <b>154-69551</b> | Stuks: 10 |  | <b>157-69551</b> | Stuks: 10 |  | <b>161-69551</b> | Stuks: 10 |
|  | <b>200-69551</b> | Stuks: 10 |  | <b>220-69551</b> | Stuks: 10 |  | <b>221-69551</b> | Stuks: 10 |

**DIN-RAIL CONNECTOR (INCL. DIN-RAIL ADAPTER EN CONNECTOR TV + SAT)**

**650-16910** Stuks: 10 DIN-rail coax F-connector TV+Sat (voor RG6 kabel)

D.1

D.2

D.3

D.4

D.5

D.6



Afdeklatten afzonderlijk te bestellen.  
Afbelingen afgewerkte producten louter ter illustratie.



De meest recente informatie  
vind je op [www.niko.eu](http://www.niko.eu)



### Coxaansluiting GEDU TV + FM

Enkel voor gebruik in rijnetten!  
 DIN 45325, IEC 60169-2  
 aansluitdemping tv, FM: 15dB ± 1dB  
 doorgangsdemping < 1dB  
 steeds te gebruiken in combinatie met een tv-versterker van min. 20dB

Sluit de afsluitweerstand 170-29601 aan op de laatste contactdoos.















#### SOKKEL



**170-79601** Stuks: 10 Met schroefklemmen en schroefbevestiging, centraafstand 71 mm

#### AFWERKINGSSET



|   |                  |           |   |                  |           |   |                  |           |
|---|------------------|-----------|---|------------------|-----------|---|------------------|-----------|
|  | <b>100-69702</b> | Stuks: 10 |  | <b>101-69702</b> | Stuks: 10 |  | <b>111-69702</b> | Stuks: 10 |
|  | <b>102-69702</b> | Stuks: 10 |  | <b>104-69702</b> | Stuks: 10 |  | <b>121-69702</b> | Stuks: 10 |
|  | <b>122-69702</b> | Stuks: 10 |  | <b>123-69702</b> | Stuks: 10 |  | <b>124-69702</b> | Stuks: 10 |
|  | <b>154-69702</b> | Stuks: 10 |  | <b>157-69702</b> | Stuks: 10 |  | <b>161-69702</b> | Stuks: 10 |
|  | <b>200-69702</b> | Stuks: 10 |  | <b>220-69702</b> | Stuks: 10 |  | <b>221-69702</b> | Stuks: 10 |

#### DIN-RAIL CONNECTOR (INCL. DIN-RAIL ADAPTER EN CONNECTOR TV)



**650-16900** Stuks: 10 DIN-rail coax F-connector TV (voor RG59 kabel)

#### ACCESSOIRES

















**170-29601** Stuks: 10 Afsluitweerstand voor GEDU aansluitingen



### Telefooncontactdoos Nederland

#### AFWERKINGSSET



|   |                  |           |   |                  |           |   |                  |           |
|---|------------------|-----------|---|------------------|-----------|---|------------------|-----------|
|  | <b>100-69010</b> | Stuks: 10 |  | <b>101-69010</b> | Stuks: 10 |  | <b>102-69010</b> | Stuks: 10 |
|  | <b>104-69010</b> | Stuks: 10 |  | <b>121-69010</b> | Stuks: 10 |  | <b>122-69010</b> | Stuks: 10 |
|  | <b>123-69010</b> | Stuks: 10 |  | <b>124-69010</b> | Stuks: 10 |  | <b>154-69010</b> | Stuks: 10 |
|  | <b>157-69010</b> | Stuks: 10 |  | <b>161-69010</b> | Stuks: 10 |  | <b>200-69010</b> | Stuks: 10 |
|  | <b>220-69010</b> | Stuks: 10 |  | <b>221-69010</b> | Stuks: 10 |   |                  |           |

#### DIN-RAIL CONNECTOR (INCL. DIN-RAIL ADAPTER EN CONNECTOR)

















**650-11113** Stuks: 10 DIN-rail montagebare RJ11 UTP



**Telefooncontactdoos 2 x RJ11 parallel****SOKKEL**

**170-79031** Stuks: 10 Met schroefklemmen en schroefbevestiging, centerafstand 71 mm

**AFWERKINGSSET**

|   |                  |           |   |                  |           |   |                  |           |
|---|------------------|-----------|---|------------------|-----------|---|------------------|-----------|
|  | <b>100-69031</b> | Stuks: 10 |  | <b>101-69031</b> | Stuks: 10 |  | <b>102-69031</b> | Stuks: 10 |
|  | <b>104-69031</b> | Stuks: 10 |  | <b>121-69031</b> | Stuks: 10 |  | <b>122-69031</b> | Stuks: 10 |
|  | <b>123-69031</b> | Stuks: 10 |  | <b>124-69031</b> | Stuks: 10 |  | <b>154-69031</b> | Stuks: 10 |
|  | <b>157-69031</b> | Stuks: 10 |  | <b>161-69031</b> | Stuks: 10 |  | <b>200-69031</b> | Stuks: 10 |
|  | <b>220-69031</b> | Stuks: 10 |  | <b>221-69031</b> | Stuks: 10 |   |                  |           |

**DIN-RAIL CONNECTOR (INCL. DIN-RAIL ADAPTER EN CONNECTOR)**

**650-11113** Stuks: 10 DIN-rail monteerbare RJ11 UTP















**ADSL/VDSL-splitter RJ11**

Geschikt voor ADSL, ADSL2, ADSL2+ en VDSL2 (standaard ITU G.933.2).

**SOKKEL**

**170-09091** Stuks: 10 Met schroefklemmen en schroefbevestiging

**AFWERKINGSSET**

|   |                  |           |   |                  |           |   |                  |           |
|---|------------------|-----------|---|------------------|-----------|---|------------------|-----------|
|  | <b>100-69091</b> | Stuks: 10 |  | <b>101-69091</b> | Stuks: 10 |  | <b>102-69091</b> | Stuks: 10 |
|  | <b>104-69091</b> | Stuks: 10 |  | <b>121-69091</b> | Stuks: 10 |  | <b>122-69091</b> | Stuks: 10 |
|  | <b>123-69091</b> | Stuks: 10 |  | <b>124-69091</b> | Stuks: 10 |  | <b>154-69091</b> | Stuks: 10 |
|  | <b>157-69091</b> | Stuks: 10 |  | <b>161-69091</b> | Stuks: 10 |  | <b>200-69091</b> | Stuks: 10 |
|  | <b>220-69091</b> | Stuks: 10 |  | <b>221-69091</b> | Stuks: 10 |   |                  |           |

**DIN-RAIL CONNECTOR (INCL. DIN-RAIL ADAPTER EN CONNECTOR)**

**650-11113** Stuks: 10 DIN-rail monteerbare RJ11 UTP

D.1

D.2

D.3

D.4

D.5

D.6



Afdeklatten afzonderlijk te bestellen.  
Afbeeldingen afgewerkte producten louter ter illustratie.



De meest recente informatie  
vind je op [www.niko.eu](http://www.niko.eu)



**1 x RJ11 UTP, vlakke uitvoering**

Incl. passtuk 9.1 en 1 connector

**SOKKEL**













**170-75213** Stuks: 10





Voor schroefbevestiging, 71 mm centerafstand

**AFWERKINGSSET MET ONDOORZICHTIG TEKSTVELD**



|   |                  |           |
|---|------------------|-----------|
|  | <b>100-65100</b> | Stuks: 10 |
|  | <b>104-65100</b> | Stuks: 10 |
|  | <b>123-65100</b> | Stuks: 10 |
|  | <b>157-65100</b> | Stuks: 10 |
|  | <b>220-65100</b> | Stuks: 10 |

|   |                  |           |
|---|------------------|-----------|
|  | <b>101-65100</b> | Stuks: 10 |
|  | <b>121-65100</b> | Stuks: 10 |
|  | <b>124-65100</b> | Stuks: 10 |
|  | <b>161-65100</b> | Stuks: 10 |
|  | <b>221-65100</b> | Stuks: 10 |

|   |                  |           |
|---|------------------|-----------|
|  | <b>102-65100</b> | Stuks: 10 |
|  | <b>122-65100</b> | Stuks: 10 |
|  | <b>154-65100</b> | Stuks: 10 |
|  | <b>200-65100</b> | Stuks: 10 |

**DIN-RAIL CONNECTOR (INCL. DIN-RAIL ADAPTER EN CONNECTOR)**



**650-11113** Stuks: 10

DIN-rail monteerbare RJ11 UTP



**2 x RJ11 UTP, vlakke uitvoering**

Incl. 2 x passtuk 9.1 en 2 connectoren

**SOKKEL**













**170-75214** Stuks: 10





Voor schroefbevestiging, 71 mm centerafstand

**AFWERKINGSSET MET ONDOORZICHTIG TEKSTVELD**



|   |                  |           |
|---|------------------|-----------|
|  | <b>100-65200</b> | Stuks: 10 |
|  | <b>102-65200</b> | Stuks: 10 |
|  | <b>122-65200</b> | Stuks: 10 |
|  | <b>154-65200</b> | Stuks: 10 |
|  | <b>200-65200</b> | Stuks: 10 |

|   |                  |           |
|---|------------------|-----------|
|  | <b>101-65200</b> | Stuks: 10 |
|  | <b>104-65200</b> | Stuks: 10 |
|  | <b>123-65200</b> | Stuks: 10 |
|  | <b>157-65200</b> | Stuks: 10 |
|  | <b>220-65200</b> | Stuks: 10 |

|   |                  |           |
|---|------------------|-----------|
|  | <b>111-65200</b> | Stuks: 10 |
|  | <b>121-65200</b> | Stuks: 10 |
|  | <b>124-65200</b> | Stuks: 10 |
|  | <b>161-65200</b> | Stuks: 10 |
|  | <b>221-65200</b> | Stuks: 10 |

**DIN-RAIL CONNECTOR (INCL. DIN-RAIL ADAPTER EN CONNECTOR)**



**650-11113** Stuks: 10

DIN-rail monteerbare RJ11 UTP



**Combinatie coax met RJ45-aansluiting Cat5E**















Combinatie coax met RJ45-aansluiting UTP Cat5E, aansluitdemping tv < 1dB.

De standaard meegeleverde cat. 5E UTP RJ45-connector kan vervangen worden door een Niko Cat5E STP (650-45055) RJ45-connector, Niko Cat6 UTP (650-45061) RJ45-connector, Niko Cat6 STP (650-45066) RJ45-connector, Niko Cat6 A UTP (650-45071) RJ45-connector of een Niko Cat6 A STP (650-45077) RJ45-connector.

**SOKKEL**

**170-65138** Stuks: 6 Voor schroefbevestiging, 71 mm centerafstand

**AFWERKINGSSET**

|   |                  |           |   |                  |           |   |                  |           |
|---|------------------|-----------|---|------------------|-----------|---|------------------|-----------|
|  | <b>100-65702</b> | Stuks: 10 |  | <b>101-65702</b> | Stuks: 10 |  | <b>102-65702</b> | Stuks: 10 |
|  | <b>104-65702</b> | Stuks: 10 |  | <b>121-65702</b> | Stuks: 10 |  | <b>122-65702</b> | Stuks: 10 |
|  | <b>123-65702</b> | Stuks: 10 |  | <b>124-65702</b> | Stuks: 10 |  | <b>154-65702</b> | Stuks: 10 |
|  | <b>157-65702</b> | Stuks: 10 |  | <b>161-65702</b> | Stuks: 10 |  | <b>200-65702</b> | Stuks: 10 |
|  | <b>220-65702</b> | Stuks: 10 |  | <b>221-65702</b> | Stuks: 10 |   |                  |           |

**VOLLEDIG APPARAAT VOOR SCHROEFBEVESTIGING, CENTERAFSTAND 71 MM**

**100-65138** Stuks: 6 **101-65138** Stuks: 6

**DIN-RAIL CONNECTOR (INCL. DIN-RAIL ADAPTER EN CONNECTOR RJ45 UTP CAT.5E)**

**650-14551** Stuks: 10 DIN-rail monteerbare RJ45 UTP Cat.5E

**DIN-RAIL CONNECTOR (INCL. DIN-RAIL ADAPTER EN CONNECTOR TV + SAT)**

**650-16910** Stuks: 10 DIN-rail coax F-connector TV+Sat (voor RG6 kabel)

D.1

D.2

D.3

D.4

D.5

D.6



Afdeklatten afzonderlijk te bestellen.  
Afbeeldingen afgewerkte producten louter ter illustratie.



De meest recente informatie  
vind je op [www.niko.eu](http://www.niko.eu)



### Combinatie coax met RJ45-aansluiting Cat6

Combinatie coax met RJ45-aansluiting UTP Cat6, aansluitdemping tv < 1dB.

De standaard meegeleverde Cat6 UTP RJ45-connector kan vervangen worden door een Niko Cat5E UTP (650-45051) RJ45-connector, Niko Cat5E STP (650-45055) RJ45-connector, Niko Cat6 STP (650-45066) RJ45-connector, Niko Cat6 A UTP (650-45071) RJ45-connector of een Niko Cat6 A STP (650-45077) RJ45-connector.

- bandbreedte 2 GHz (Ziggo geschikt)

#### SOKKEL



**170-65238**

Stuks: 6

Voor schroefbevestiging, 71 mm centerafstand

#### AFWERKINGSSET



**100-65702** Stuks: 10

**104-65702** Stuks: 10

**123-65702** Stuks: 10

**157-65702** Stuks: 10

**220-65702** Stuks: 10

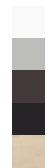

**101-65702** Stuks: 10

**121-65702** Stuks: 10

**124-65702** Stuks: 10

**161-65702** Stuks: 10

**221-65702** Stuks: 10



**102-65702** Stuks: 10

**122-65702** Stuks: 10

**154-65702** Stuks: 10

**200-65702** Stuks: 10

#### VOLLEDIG APPARAAT VOOR SCHROEFBEVESTIGING, CENTERAFSTAND 71 MM



**100-65238** Stuks: 6



**101-65238** Stuks: 6

#### DIN-RAIL CONNECTOR (INCL. DIN-RAIL ADAPTER EN CONNECTOR RJ45 UTP CAT6)



**650-14561**

Stuks: 10

DIN-rail monteerbare RJ45 UTP Cat.6

#### DIN-RAIL CONNECTOR (INCL. DIN-RAIL ADAPTER EN CONNECTOR TV + SAT)



**650-16910**

Stuks: 10

DIN-rail coax F-connector TV+Sat (voor RG6 kabel)



**Combinatie coax met RJ45-aansluiting Cat6 A**

Combinatie coax met RJ45-aansluiting UTP Cat6 A, aansluitdemping tv < 1dB.

De standaard meegeleverde Cat6 A UTP RJ45-connector kan vervangen worden door een Niko Cat5E UTP (650-45051) RJ45-connector, Niko Cat5E STP (650-45055) RJ45-connector, Niko Cat6 UTP (650-45061) RJ45-connector, Niko Cat6 STP (650-45066) RJ45-connector of een Niko Cat6 A STP (650-45077) RJ45-connector.

- bandbreedte 2 GHz (Ziggo geschikt)



NIEUW

**SOKKEL**

**170-65338** Stuks: 6

**AFWERKINGSSET**

|  |                  |           |  |                  |           |  |                  |           |
|--|------------------|-----------|--|------------------|-----------|--|------------------|-----------|
|  | <b>100-65702</b> | Stuks: 10 |  | <b>101-65702</b> | Stuks: 10 |  | <b>102-65702</b> | Stuks: 10 |
|  | <b>104-65702</b> | Stuks: 10 |  | <b>121-65702</b> | Stuks: 10 |  | <b>122-65702</b> | Stuks: 10 |
|  | <b>123-65702</b> | Stuks: 10 |  | <b>124-65702</b> | Stuks: 10 |  | <b>154-65702</b> | Stuks: 10 |
|  | <b>157-65702</b> | Stuks: 10 |  | <b>161-65702</b> | Stuks: 10 |  | <b>200-65702</b> | Stuks: 10 |
|  | <b>220-65702</b> | Stuks: 10 |  | <b>221-65702</b> | Stuks: 10 |  |                  |           |

**VOLLEDIG APPARAAT VOOR SCHROEFBEVESTIGING, CENTERAFSTAND 71 MM**

**100-65338** Stuks: 6      **101-65338** Stuks: 6

**DIN-RAIL CONNECTOR (INCL. DIN-RAIL ADAPTER EN CONNECTOR RJ45 UTP CAT.6 A)**

NIEUW

**650-14571** Stuks: 10      DIN-rail monteerbare RJ45 UTP Cat.6 A

**DIN-RAIL CONNECTOR (INCL. DIN-RAIL ADAPTER EN CONNECTOR TV + SAT)**

**650-16910** Stuks: 10      DIN-rail coax F-connector TV+Sat (voor RG6 kabel)

**1 x RJ45 UTP Cat5E, vlakke uitvoering**

Incl. passtuk 9.1 en 1 connector

**SOKKEL**

**170-75251** Stuks: 10      Voor schroefbevestiging, 71 mm centerafstand

**AFWERKINGSSET MET ONDOORZICHTIG TEKSTVELD**

|  |                  |           |  |                  |           |  |                  |           |
|--|------------------|-----------|--|------------------|-----------|--|------------------|-----------|
|  | <b>100-65100</b> | Stuks: 10 |  | <b>101-65100</b> | Stuks: 10 |  | <b>102-65100</b> | Stuks: 10 |
|  | <b>104-65100</b> | Stuks: 10 |  | <b>121-65100</b> | Stuks: 10 |  | <b>122-65100</b> | Stuks: 10 |
|  | <b>123-65100</b> | Stuks: 10 |  | <b>124-65100</b> | Stuks: 10 |  | <b>154-65100</b> | Stuks: 10 |
|  | <b>157-65100</b> | Stuks: 10 |  | <b>161-65100</b> | Stuks: 10 |  | <b>200-65100</b> | Stuks: 10 |
|  | <b>220-65100</b> | Stuks: 10 |  | <b>221-65100</b> | Stuks: 10 |  |                  |           |

**VOLLEDIG APPARAAT MET SCHROEFBEVESTIGING**

**100-75251** Stuks: 10      **101-75251** Stuks: 10

**DIN-RAIL CONNECTOR (INCL. DIN-RAIL ADAPTER EN CONNECTOR RJ45 UTP CAT.5E)**

**650-14551** Stuks: 10      DIN-rail monteerbare RJ45 UTP Cat.5E



Afdekkapen afzonderlijk te bestellen.  
Afbeldingen afgewerkte producten louter ter illustratie.



De meest recente informatie  
vind je op [www.niko.eu](http://www.niko.eu)

D.1

D.2

D.3

D.4

D.5

D.6



**2 x RJ45 UTP Cat5E, vlakke uitvoering**

Incl. passtuk 9.1 en 2 connectoren

**SOKKEL**



**170-75252** Stuks: 10

Voor schroefbevestiging, 71 mm centerafstand

**AFWERKINGSSET MET ONDOORZICHTIG TEKSTVELD**



**100-65200** Stuks: 10  
**102-65200** Stuks: 10  
**122-65200** Stuks: 10  
**154-65200** Stuks: 10  
**200-65200** Stuks: 10

**101-65200** Stuks: 10  
**104-65200** Stuks: 10  
**123-65200** Stuks: 10  
**157-65200** Stuks: 10  
**220-65200** Stuks: 10

**111-65200** Stuks: 10  
**121-65200** Stuks: 10  
**124-65200** Stuks: 10  
**161-65200** Stuks: 10  
**221-65200** Stuks: 10

**VOLLEDIG APPARAAT MET SCHROEFBEVESTIGING**



**100-75252** Stuks: 10

**101-75252** Stuks: 10

**111-75252** Stuks: 10

**DIN-RAIL CONNECTOR (INCL. DIN-RAIL ADAPTER EN CONNECTOR RJ45 UTP CAT.5E)**



**650-14551** Stuks: 10

DIN-rail monteerbare RJ45 UTP Cat.5E



**1 x RJ45 STP Cat5E, vlakke uitvoering**

Incl. passtuk 9.1 en 1 connector

**SOKKEL**



**170-75255** Stuks: 10

Voor schroefbevestiging, 71 mm centerafstand

**AFWERKINGSSET MET ONDOORZICHTIG TEKSTVELD**



**100-65100** Stuks: 10  
**104-65100** Stuks: 10  
**123-65100** Stuks: 10  
**157-65100** Stuks: 10  
**220-65100** Stuks: 10

**101-65100** Stuks: 10  
**121-65100** Stuks: 10  
**124-65100** Stuks: 10  
**161-65100** Stuks: 10  
**221-65100** Stuks: 10

**102-65100** Stuks: 10  
**122-65100** Stuks: 10  
**154-65100** Stuks: 10  
**200-65100** Stuks: 10

**VOLLEDIG APPARAAT VOOR SCHROEFBEVESTIGING**



**100-75255** Stuks: 10

**101-75255** Stuks: 10

**DIN-RAIL CONNECTOR (INCL. DIN-RAIL ADAPTER EN CONNECTOR RJ45 STP CAT.5E)**



**650-14555** Stuks: 10

DIN-rail monteerbare RJ45 STP Cat.5E



Afdekplaten afzonderlijk te bestellen.  
 Afbeeldingen afgewerkte producten louter ter illustratie.



**2 x RJ45 STP Cat5E, vlakke uitvoering**

Incl. 2 x passtuk 9.1 en 2 connectoren

**SOKKEL****170-75256** Stuks: 10

Voor schroefbevestiging, 71 mm centerafstand

**AFWERKINGSSET MET ONDOORZICHTIG TEKSTVELD**

|  |                  |           |  |                  |           |  |                  |           |
|--|------------------|-----------|--|------------------|-----------|--|------------------|-----------|
|  | <b>100-65200</b> | Stuks: 10 |  | <b>101-65200</b> | Stuks: 10 |  | <b>111-65200</b> | Stuks: 10 |
|  | <b>102-65200</b> | Stuks: 10 |  | <b>104-65200</b> | Stuks: 10 |  | <b>121-65200</b> | Stuks: 10 |
|  | <b>122-65200</b> | Stuks: 10 |  | <b>123-65200</b> | Stuks: 10 |  | <b>124-65200</b> | Stuks: 10 |
|  | <b>154-65200</b> | Stuks: 10 |  | <b>157-65200</b> | Stuks: 10 |  | <b>161-65200</b> | Stuks: 10 |
|  | <b>200-65200</b> | Stuks: 10 |  | <b>220-65200</b> | Stuks: 10 |  | <b>221-65200</b> | Stuks: 10 |

**VOLLEDIG APPARAAT VOOR SCHROEFBEVESTIGING** **100-75256** Stuks: 10 **101-75256** Stuks: 10**DIN-RAIL CONNECTOR (INCL. DIN-RAIL ADAPTER EN CONNECTOR RJ45 STP CAT.5E)****650-14555** Stuks: 10

DIN-rail monteerbare RJ45 STP Cat.5E

**1 x RJ45 UTP Cat6, vlakke uitvoering**

Incl. passtuk 9.1 en 1 connector

**SOKKEL****170-75261** Stuks: 10

Voor schroefbevestiging, 71 mm centerafstand

**AFWERKINGSSET MET ONDOORZICHTIG TEKSTVELD**

|  |                  |           |  |                  |           |  |                  |           |
|--|------------------|-----------|--|------------------|-----------|--|------------------|-----------|
|  | <b>100-65100</b> | Stuks: 10 |  | <b>101-65100</b> | Stuks: 10 |  | <b>102-65100</b> | Stuks: 10 |
|  | <b>104-65100</b> | Stuks: 10 |  | <b>121-65100</b> | Stuks: 10 |  | <b>122-65100</b> | Stuks: 10 |
|  | <b>123-65100</b> | Stuks: 10 |  | <b>124-65100</b> | Stuks: 10 |  | <b>154-65100</b> | Stuks: 10 |
|  | <b>157-65100</b> | Stuks: 10 |  | <b>161-65100</b> | Stuks: 10 |  | <b>200-65100</b> | Stuks: 10 |
|  | <b>220-65100</b> | Stuks: 10 |  | <b>221-65100</b> | Stuks: 10 |  |                  |           |

**DIN-RAIL CONNECTOR (INCL. DIN-RAIL ADAPTER EN CONNECTOR RJ45 UTP CAT6)****650-14561** Stuks: 10

DIN-rail monteerbare RJ45 UTP Cat.6

D.1

D.2

D.3

D.4

D.5

D.6



Afdekkplaten afzonderlijk te bestellen.  
Afbeeldingen afgewerkte producten louter ter illustratie.



De meest recente informatie  
vind je op [www.niko.eu](http://www.niko.eu)



**2 x RJ45 UTP Cat6, vlakke uitvoering**

Incl. 2 x passtuk 9.1 en 2 connectoren

**SOKKEL**



**170-75262** Stuks: 10

Voor schroefbevestiging, 71 mm centerafstand

**AFWERKINGSSET MET ONDOORZICHTIG TEKSTVELD**



|  |                  |           |
|--|------------------|-----------|
|  | <b>100-65200</b> | Stuks: 10 |
|  | <b>102-65200</b> | Stuks: 10 |
|  | <b>122-65200</b> | Stuks: 10 |
|  | <b>154-65200</b> | Stuks: 10 |
|  | <b>200-65200</b> | Stuks: 10 |

|  |                  |           |
|--|------------------|-----------|
|  | <b>101-65200</b> | Stuks: 10 |
|  | <b>104-65200</b> | Stuks: 10 |
|  | <b>123-65200</b> | Stuks: 10 |
|  | <b>157-65200</b> | Stuks: 10 |
|  | <b>220-65200</b> | Stuks: 10 |

|  |                  |           |
|--|------------------|-----------|
|  | <b>111-65200</b> | Stuks: 10 |
|  | <b>121-65200</b> | Stuks: 10 |
|  | <b>124-65200</b> | Stuks: 10 |
|  | <b>161-65200</b> | Stuks: 10 |
|  | <b>221-65200</b> | Stuks: 10 |

**DIN-RAIL CONNECTOR (INCL. DIN-RAIL ADAPTER EN CONNECTOR RJ45 UTP CAT6)**



**650-14561** Stuks: 10

DIN-rail monteerbare RJ45 UTP Cat.6



**2 x RJ45 UTP Cat6, schuine uitvoering**

Incl. 1 x passtuk 9.4 en 2 connectoren

**SOKKEL**



**170-75362** Stuks: 10

Voor schroefbevestiging, 71 mm centerafstand

**AFWERKINGSSET MET TRANSPARANT TEKSTVELD, SCHUIN**



|  |                  |           |
|--|------------------|-----------|
|  | <b>100-65400</b> | Stuks: 10 |
|  | <b>104-65400</b> | Stuks: 10 |
|  | <b>123-65400</b> | Stuks: 10 |
|  | <b>157-65400</b> | Stuks: 10 |
|  | <b>220-65400</b> | Stuks: 10 |

|  |                  |           |
|--|------------------|-----------|
|  | <b>101-65400</b> | Stuks: 10 |
|  | <b>121-65400</b> | Stuks: 10 |
|  | <b>124-65400</b> | Stuks: 10 |
|  | <b>161-65400</b> | Stuks: 10 |
|  | <b>221-65400</b> | Stuks: 10 |

|  |                  |           |
|--|------------------|-----------|
|  | <b>102-65400</b> | Stuks: 10 |
|  | <b>122-65400</b> | Stuks: 10 |
|  | <b>154-65400</b> | Stuks: 10 |
|  | <b>200-65400</b> | Stuks: 10 |

**DIN-RAIL CONNECTOR (INCL. DIN-RAIL ADAPTER EN CONNECTOR RJ45 UTP CAT6)**



**650-14561** Stuks: 10

DIN-rail monteerbare RJ45 UTP Cat.6



Afdekplaten afzonderlijk te bestellen.  
Afbeeldingen afgewerkte producten louter ter illustratie.

**1 x RJ45 STP Cat6, vlakke uitvoering**

Incl. passtuk 9.1 en 1 connector

**SOKKEL****170-75266** Stuks: 10 voor schroefbevestiging, 71 mm centerafstand**AFWERKINGSSET MET ONDOORZICHTIG TEKSTVELD**

|  |                  |           |  |                  |           |  |                  |           |
|--|------------------|-----------|--|------------------|-----------|--|------------------|-----------|
|  | <b>100-65100</b> | Stuks: 10 |  | <b>101-65100</b> | Stuks: 10 |  | <b>102-65100</b> | Stuks: 10 |
|  | <b>104-65100</b> | Stuks: 10 |  | <b>121-65100</b> | Stuks: 10 |  | <b>122-65100</b> | Stuks: 10 |
|  | <b>123-65100</b> | Stuks: 10 |  | <b>124-65100</b> | Stuks: 10 |  | <b>154-65100</b> | Stuks: 10 |
|  | <b>157-65100</b> | Stuks: 10 |  | <b>161-65100</b> | Stuks: 10 |  | <b>200-65100</b> | Stuks: 10 |
|  | <b>220-65100</b> | Stuks: 10 |  | <b>221-65100</b> | Stuks: 10 |  |                  |           |

**DIN-RAIL CONNECTOR (INCL. DIN-RAIL ADAPTER EN CONNECTOR RJ45 STP CAT.6)****650-14566** Stuks: 10 DIN-rail monteerbare RJ45 STP Cat.6**2 x RJ45 STP Cat6, vlakke uitvoering**

Incl. 2 x passtuk 9.1 en 2 connectoren

**SOKKEL****170-75267** Stuks: 10 voor schroefbevestiging, 71 mm centerafstand**AFWERKINGSSET MET ONDOORZICHTIG TEKSTVELD**

|  |                  |           |  |                  |           |  |                  |           |
|--|------------------|-----------|--|------------------|-----------|--|------------------|-----------|
|  | <b>100-65200</b> | Stuks: 10 |  | <b>101-65200</b> | Stuks: 10 |  | <b>111-65200</b> | Stuks: 10 |
|  | <b>102-65200</b> | Stuks: 10 |  | <b>104-65200</b> | Stuks: 10 |  | <b>121-65200</b> | Stuks: 10 |
|  | <b>122-65200</b> | Stuks: 10 |  | <b>123-65200</b> | Stuks: 10 |  | <b>124-65200</b> | Stuks: 10 |
|  | <b>154-65200</b> | Stuks: 10 |  | <b>157-65200</b> | Stuks: 10 |  | <b>161-65200</b> | Stuks: 10 |
|  | <b>200-65200</b> | Stuks: 10 |  | <b>220-65200</b> | Stuks: 10 |  | <b>221-65200</b> | Stuks: 10 |

**DIN-RAIL CONNECTOR (INCL. DIN-RAIL ADAPTER EN CONNECTOR RJ45 STP CAT.6)****650-14566** Stuks: 10 DIN-rail monteerbare RJ45 STP Cat.6

D.1  
**D.2**  
 D.3  
 D.4  
 D.5  
 D.6



Afdekplaten afzonderlijk te bestellen.  
 Afbeeldingen afgewerkte producten louter ter illustratie.



De meest recente informatie  
 vind je op [www.niko.eu](http://www.niko.eu)



**2 x RJ45 STP Cat6, schuine uitvoering**

Incl. 1 x passtuk 9.4 en 2 connectoren















**SOKKEL**



**170-75367** Stuks: 10 voor schroefbevestiging, 71 mm centerafstand

**AFWERKINGSSET MET TRANSPARANT TEKSTVELD, SCHUIN**



|   |                  |           |   |                  |           |   |                  |           |
|---|------------------|-----------|---|------------------|-----------|---|------------------|-----------|
|  | <b>100-65400</b> | Stuks: 10 |  | <b>101-65400</b> | Stuks: 10 |  | <b>102-65400</b> | Stuks: 10 |
|  | <b>104-65400</b> | Stuks: 10 |  | <b>121-65400</b> | Stuks: 10 |  | <b>122-65400</b> | Stuks: 10 |
|  | <b>123-65400</b> | Stuks: 10 |  | <b>124-65400</b> | Stuks: 10 |  | <b>154-65400</b> | Stuks: 10 |
|  | <b>157-65400</b> | Stuks: 10 |  | <b>161-65400</b> | Stuks: 10 |  | <b>200-65400</b> | Stuks: 10 |
|  | <b>220-65400</b> | Stuks: 10 |  | <b>221-65400</b> | Stuks: 10 |   |                  |           |

**DIN-RAIL CONNECTOR (INCL. DIN-RAIL ADAPTER EN CONNECTOR RJ45 STP CAT.6)**



**650-14566** Stuks: 10 DIN-rail monteerbare RJ45 STP Cat.6



**NIEUW**

**1 x RJ45 UTP Cat6 A, vlakke uitvoering**

Incl. passtuk 9.1 en 1 connector















**SOKKEL**



**170-75271** Stuks: 10

**AFWERKINGSSET MET ONDOORZICHTIG TEKSTVELD**



|   |                  |           |   |                  |           |   |                  |           |
|---|------------------|-----------|---|------------------|-----------|---|------------------|-----------|
|  | <b>100-65100</b> | Stuks: 10 |  | <b>101-65100</b> | Stuks: 10 |  | <b>102-65100</b> | Stuks: 10 |
|  | <b>104-65100</b> | Stuks: 10 |  | <b>121-65100</b> | Stuks: 10 |  | <b>122-65100</b> | Stuks: 10 |
|  | <b>123-65100</b> | Stuks: 10 |  | <b>124-65100</b> | Stuks: 10 |  | <b>154-65100</b> | Stuks: 10 |
|  | <b>157-65100</b> | Stuks: 10 |  | <b>161-65100</b> | Stuks: 10 |  | <b>200-65100</b> | Stuks: 10 |
|  | <b>220-65100</b> | Stuks: 10 |  | <b>221-65100</b> | Stuks: 10 |   |                  |           |

**DIN-RAIL CONNECTOR (INCL. DIN-RAIL ADAPTER EN CONNECTOR RJ45 UTP CAT.6 A)**



**NIEUW** **650-14571** Stuks: 10 DIN-rail monteerbare RJ45 UTP Cat.6 A



Afdeklatten afzonderlijk te bestellen.  
Afbeldingen afgewerkte producten louter ter illustratie.















**2 x RJ45 UTP Cat6 A, vlakke uitvoering**

Incl. 2 x passtuk 9.1 en 2 connectoren



NIEUW

**170-75272** Stuks: 10**AFWERKINGSSET MET ONDOORZICHTIG TEKSTVELD**

|   |                  |           |   |                  |           |   |                  |           |
|---|------------------|-----------|---|------------------|-----------|---|------------------|-----------|
|  | <b>100-65200</b> | Stuks: 10 |  | <b>101-65200</b> | Stuks: 10 |  | <b>111-65200</b> | Stuks: 10 |
|  | <b>102-65200</b> | Stuks: 10 |  | <b>104-65200</b> | Stuks: 10 |  | <b>121-65200</b> | Stuks: 10 |
|  | <b>122-65200</b> | Stuks: 10 |  | <b>123-65200</b> | Stuks: 10 |  | <b>124-65200</b> | Stuks: 10 |
|  | <b>154-65200</b> | Stuks: 10 |  | <b>157-65200</b> | Stuks: 10 |  | <b>161-65200</b> | Stuks: 10 |
|  | <b>200-65200</b> | Stuks: 10 |  | <b>220-65200</b> | Stuks: 10 |  | <b>221-65200</b> | Stuks: 10 |

**DIN-RAIL CONNECTOR (INCL. DIN-RAIL ADAPTER EN CONNECTOR RJ45 UTP CAT.6 A)**

NIEUW

**650-14571** Stuks: 10

DIN-rail monteerbare RJ45 UTP Cat.6 A















**2 x RJ45 UTP Cat6 A, schuine uitvoering**

Incl. 1 x passtuk 9.4 and 2 connectoren



NIEUW

**SOKKEL****170-75372** Stuks: 10**AFWERKINGSSET MET TRANSPARANT TEKSTVELD, SCHUIN**

|   |                  |           |   |                  |           |   |                  |           |
|---|------------------|-----------|---|------------------|-----------|---|------------------|-----------|
|  | <b>100-65400</b> | Stuks: 10 |  | <b>101-65400</b> | Stuks: 10 |  | <b>102-65400</b> | Stuks: 10 |
|  | <b>104-65400</b> | Stuks: 10 |  | <b>121-65400</b> | Stuks: 10 |  | <b>122-65400</b> | Stuks: 10 |
|  | <b>123-65400</b> | Stuks: 10 |  | <b>124-65400</b> | Stuks: 10 |  | <b>154-65400</b> | Stuks: 10 |
|  | <b>157-65400</b> | Stuks: 10 |  | <b>161-65400</b> | Stuks: 10 |  | <b>200-65400</b> | Stuks: 10 |
|  | <b>220-65400</b> | Stuks: 10 |  | <b>221-65400</b> | Stuks: 10 |   |                  |           |

**DIN-RAIL CONNECTOR (INCL. DIN-RAIL ADAPTER EN CONNECTOR RJ45 UTP CAT.6 A)**

NIEUW

**650-14571** Stuks: 10

DIN-rail monteerbare RJ45 UTP Cat.6 A

D.1

D.2

D.3

D.4

D.5

D.6



Afdekplaten afzonderlijk te bestellen.  
Afbeeldingen afgewerkte producten louter ter illustratie.



De meest recente informatie  
vind je op [www.niko.eu](http://www.niko.eu)



NIEUW

**1 x RJ45 STP Cat6 A, vlakke uitvoering**

Incl. passtuk 9.1 en 1 connector

**SOKKEL**



**170-75277** Stuks: 10

Voor schroefbevestiging

**AFWERKINGSSET MET ONDOORZICHTIG TEKSTVELD**



**100-65100** Stuks: 10  
**104-65100** Stuks: 10  
**123-65100** Stuks: 10  
**157-65100** Stuks: 10  
**220-65100** Stuks: 10



**101-65100** Stuks: 10  
**121-65100** Stuks: 10  
**124-65100** Stuks: 10  
**161-65100** Stuks: 10  
**221-65100** Stuks: 10



**102-65100** Stuks: 10  
**122-65100** Stuks: 10  
**154-65100** Stuks: 10  
**200-65100** Stuks: 10

**DIN-RAIL CONNECTOR (INCL. DIN-RAIL ADAPTER EN CONNECTOR RJ45 STP CAT.6 A)**



NIEUW

**650-14577** Stuks: 10

DIN-rail monteerbare RJ45 STP Cat.6 A



NIEUW

**2 x RJ45 STP Cat6 A, vlakke uitvoering**

Incl. 2 x passtuk 9.1 en 2 connectoren

**SOKKEL**



**170-75278** Stuks: 10

**AFWERKINGSSET MET ONDOORZICHTIG TEKSTVELD**



**100-65200** Stuks: 10  
**102-65200** Stuks: 10  
**122-65200** Stuks: 10  
**154-65200** Stuks: 10  
**200-65200** Stuks: 10



**101-65200** Stuks: 10  
**104-65200** Stuks: 10  
**123-65200** Stuks: 10  
**157-65200** Stuks: 10  
**220-65200** Stuks: 10



**111-65200** Stuks: 10  
**121-65200** Stuks: 10  
**124-65200** Stuks: 10  
**161-65200** Stuks: 10  
**221-65200** Stuks: 10

**DIN-RAIL CONNECTOR (INCL. DIN-RAIL ADAPTER EN CONNECTOR RJ45 STP CAT.6 A)**



NIEUW

**650-14577** Stuks: 10

DIN-rail monteerbare RJ45 STP Cat.6 A



Afdekplaten afzonderlijk te bestellen.  
 Afbeeldingen afgewerkte producten louter ter illustratie.















**2 x RJ45 STP Cat6 A, schuine uitvoering**

Incl. 1 x passtuk 9.4 en 2 connectoren



NIEUW

**SOKKEL****170-75377** Stuks: 10**AFWERKINGSSET MET TRANSPARANT TEKSTVELD, SCHUIN**

|   |                  |           |   |                  |           |   |                  |           |
|---|------------------|-----------|---|------------------|-----------|---|------------------|-----------|
|  | <b>100-65400</b> | Stuks: 10 |  | <b>101-65400</b> | Stuks: 10 |  | <b>102-65400</b> | Stuks: 10 |
|  | <b>104-65400</b> | Stuks: 10 |  | <b>121-65400</b> | Stuks: 10 |  | <b>122-65400</b> | Stuks: 10 |
|  | <b>123-65400</b> | Stuks: 10 |  | <b>124-65400</b> | Stuks: 10 |  | <b>154-65400</b> | Stuks: 10 |
|  | <b>157-65400</b> | Stuks: 10 |  | <b>161-65400</b> | Stuks: 10 |  | <b>200-65400</b> | Stuks: 10 |
|  | <b>220-65400</b> | Stuks: 10 |  | <b>221-65400</b> | Stuks: 10 |   |                  |           |

**DIN-RAIL CONNECTOR (INCL. DIN-RAIL ADAPTER EN CONNECTOR RJ45 STP CAT.6 A)**

NIEUW

**650-14577** Stuks: 10

DIN-rail monteerbare RJ45 STP Cat.6 A

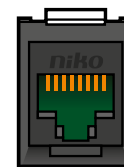
**Connectoren****CONNECTOREN****650-45051** Stuks: 10 RJ45-connector, UTP, cat. 5E**650-45055** Stuks: 10 RJ45-connector, STP, cat. 5E**650-45061** Stuks: 10 RJ45-connector, UTP, cat. 6**650-45066** Stuks: 10 RJ45-connector, STP, cat. 6**650-45013** Stuks: 10 RJ11-connector, UTP

NIEUW

**650-45071** Stuks: 10 RJ45-connector, UTP, cat.6 A

NIEUW

**650-45077** Stuks: 10 RJ45-connector, STP, cat.6 A

D.1

D.2

D.3

D.4

D.5

D.6



Afdekplaten afzonderlijk te bestellen.  
Afbeeldingen afgewerkte producten louter ter illustratie.



De meest recente informatie  
vind je op [www.niko.eu](http://www.niko.eu)



## DIN-rail connectoren

inclusief DIN-rail adapter en connector

### DIN-RAIL CONNECTOR (INCL. DIN-RAIL ADAPTER EN CONNECTOR)



**650-11113** Stuks: 10 DIN-rail monteerbare RJ11 UTP

### DIN-RAIL CONNECTOR (INCL. DIN-RAIL ADAPTER EN CONNECTOR RJ45 UTP CAT.5E)



**650-14551** Stuks: 10 DIN-rail monteerbare RJ45 UTP Cat.5E

### DIN-RAIL CONNECTOR (INCL. DIN-RAIL ADAPTER EN CONNECTOR RJ45 STP CAT.5E)



**650-14555** Stuks: 10 DIN-rail monteerbare RJ45 STP Cat.5E

### DIN-RAIL CONNECTOR (INCL. DIN-RAIL ADAPTER EN CONNECTOR RJ45 UTP CAT6)



**650-14561** Stuks: 10 DIN-rail monteerbare RJ45 UTP Cat.6

### DIN-RAIL CONNECTOR (INCL. DIN-RAIL ADAPTER EN CONNECTOR RJ45 STP CAT.6)



**650-14566** Stuks: 10 DIN-rail monteerbare RJ45 STP Cat.6

### DIN-RAIL CONNECTOR (INCL. DIN-RAIL ADAPTER EN CONNECTOR RJ45 UTP CAT.6 A)



**NIEUW** **650-14571** Stuks: 10 DIN-rail monteerbare RJ45 UTP Cat.6 A

### DIN-RAIL CONNECTOR (INCL. DIN-RAIL ADAPTER EN CONNECTOR RJ45 STP CAT.6 A)



**NIEUW** **650-14577** Stuks: 10 DIN-rail monteerbare RJ45 STP Cat.6 A

### DIN-RAIL CONNECTOR (INCL. DIN-RAIL ADAPTER EN CONNECTOR TV)



**650-16900** Stuks: 10 DIN-rail coax F-connector TV (voor RG59 kabel)

### DIN-RAIL CONNECTOR (INCL. DIN-RAIL ADAPTER EN CONNECTOR TV + SAT)



**650-16910** Stuks: 10 DIN-rail coax F-connector TV+Sat (voor RG6 kabel)





## Toebehoren

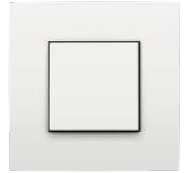

## SOKKEL



**170-68900** Stuks: 10 Voor schroefbevestiging

## TRANSPARANT TEKSTVELD



**190-65000** Stuks: 50 Transparant tekstveld

## BLINDPLAATJES 45X45 MM



**100-76901** Stuks: 10  
**102-76901** Stuks: 10  
**122-76901** Stuks: 10  
**154-76901** Stuks: 10  
**200-76901** Stuks: 10



**101-76901** Stuks: 10  
**104-76901** Stuks: 10  
**123-76901** Stuks: 10  
**157-76901** Stuks: 10  
**220-76901** Stuks: 10



**111-76901** Stuks: 10  
**121-76901** Stuks: 10  
**124-76901** Stuks: 10  
**161-76901** Stuks: 10  
**221-76901** Stuks: 10

D.1

D.2

D.3

D.4

D.5

D.6



Afdekplaten afzonderlijk te bestellen.  
 Afbeeldingen afgewerkte producten louter ter illustratie.



De meest recente informatie  
 vind je op [www.niko.eu](http://www.niko.eu)

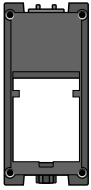

## Passtukken

Raadpleeg ook de tabel "Datacomaansluitingen voor andere RJ-connectoren" in het hoofdstuk "Medianetwerk".

### PASSTUKKEN VOOR VLAKKE UITVOERING VOOR NIKO CONNECTOREN 650-450XX, ENKELVOUDIG



**170-65901** Stuks: 10 Enkelvoudig passtuk 9.1

### PASSTUKKEN VOOR VLAKKE UITVOERING VOOR ANDERE MERKEN, ENKELVOUDIG



**170-65101** Stuks: 10 Enkelvoudig passtuk 1 (voor AMP, Siemon, Nexans, Brandrex,...)



**170-65201** Stuks: 10 Enkelvoudig passtuk 2 (voor systimax,...)



**170-65501** Stuks: 10 Enkelvoudig passtuk 5 (voor Krone, Kerpen, Radiall, Gigamedia,...)



**170-65601** Stuks: 10 Enkelvoudig passtuk 6 (voor Panduit,...)



**170-65701** Stuks: 10 Enkelvoudig passtuk 7 (voor CAE, Multimedia Connect/MMC, Abitana, Prysmian, Molex,...)

### PASSTUKKEN VOOR VLAKKE UITVOERING VOOR OUDE NIKO CONNECTOREN 02-399-XX, ENKELVOUDIG



**170-65401** Stuks: 10 Enkelvoudig passtuk 4.1

### PASSTUKKEN VOOR VLAKKE UITVOERING VOOR OUDE NIKO CONNECTOREN 02-399-XX, DUBBEL



**170-65402** Stuks: 10 Tweevoudig passtuk 4.2

### PASSTUKKEN VOOR VLAKKE UITVOERING VOOR ANDERE MERKEN, DUBBEL



**170-65302** Stuks: 10 Tweevoudig passtuk 3.2

### PASSTUKKEN VOOR SCHUINE UITVOERING VOOR NIKO CONNECTOREN 650-450XX, DUBBEL



**170-65904** Stuks: 10 Tweevoudig schuin passtuk 9.4

### PASSTUKKEN VOOR SCHUINE UITVOERING VOOR OUDE NIKO CONNECTOREN 02-399-XX, DUBBEL



**170-65404** Stuks: 10 Tweevoudig schuin passtuk 4.4





# Niko opbouwkit

## Meer vaart in je (ver)bouwprojecten

Bouw- of renovatieprojecten schieten een stuk sneller op dankzij de opbouwkit. In combinatie met de inbouwfuncties van Niko is deze kit dé ideale opbouwoplossing.

### VOORDELEN



#### Eenvoudig

- maar 4 referentiecodes
- enkelvoudige en tweevoudige uitvoering
- beschikbaar in cream en white
- horizontale en verticale montage mogelijk
- geen montageplaat meer nodig



#### Functioneel

- uitgebreide mogelijkheden: combineerbaar met het volledige gamma inbouwfuncties
- snelle en eenvoudige montage en bedrading
  - geschikt voor montage op elke ondergrond
  - grote bedravingsruimte bij compacte afmetingen van de opbouwdozen
  - perfecte afwerking bij aansluiting op plinten en lijsten via gemakkelijk verwijderbare uitbreekpoorten
  - geschikt voor aansluiting van kabels en buizen via de optionele metrische buisingangen

#### Elegant

- verzorgd design aanleunend bij Niko Original en Niko Intense
- perfect combineerbaar en integreerbaar in de leefomgeving

#### Duurzame kwaliteit

- vormvaste kunststof pc/asa
- condenswaterdicht (IP21)
- slagvast (IK06)

D.1

D.2

D.3

D.4

D.5

D.6



De meest recente informatie  
vind je op [www.niko.eu](http://www.niko.eu)



### Enkelvoudige opbouwkit

De enkelvoudige opbouwkit met bijgeleverde schroeven is combineerbaar met alle producten uit het Niko inbouwgamma, met uitzondering van de tijdschakelaars, de bewegingsmelders 110° en de wandcontactdoos met overspanningsbeveiliging.

#### VOLLEDIG APPARAAT

|                  |           |       |
|------------------|-----------|-------|
| <b>100-80100</b> | Stuks: 10 | cream |
| <b>101-80100</b> | Stuks: 10 | white |



### Tweevoudige opbouwkit

De tweevoudige opbouwkit met bijgeleverde schroeven is combineerbaar met alle producten uit het Niko inbouwgamma, met uitzondering van de tijdschakelaars, de bewegingsmelders 110° en de wandcontactdoos met overspanningsbeveiliging.

#### VOLLEDIG APPARAAT

|                  |          |       |
|------------------|----------|-------|
| <b>100-80200</b> | Stuks: 5 | cream |
| <b>101-80200</b> | Stuks: 5 | white |

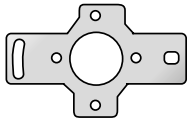

### Montagekruis

Dit verzinkt montagekruis is geschikt om enkelvoudige en tweevoudige opbouwkits verticaal te monteren op inbouwdozen met een centerafstand van 65 mm tussen de bevestigingsgaten.

#### VOLLEDIG APPARAAT

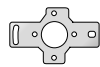

|                  |           |
|------------------|-----------|
| <b>170-30700</b> | Stuks: 10 |
|------------------|-----------|

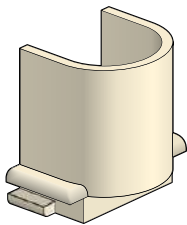

### Buisingangen

#### M16-BUISINGANG



|               |           |       |
|---------------|-----------|-------|
| <b>11-865</b> | Stuks: 50 | cream |
|---------------|-----------|-------|



|               |           |       |
|---------------|-----------|-------|
| <b>31-865</b> | Stuks: 50 | white |
|---------------|-----------|-------|

#### M20-BUISINGANG



|               |           |       |
|---------------|-----------|-------|
| <b>11-866</b> | Stuks: 50 | cream |
|---------------|-----------|-------|



|               |           |       |
|---------------|-----------|-------|
| <b>31-866</b> | Stuks: 50 | white |
|---------------|-----------|-------|







# Niko Hydro

## De waterdichte oplossing

Niko Hydro werd speciaal ontworpen voor veeleisende en vochtige omgevingen. De volledige reeks is ook beschikbaar in wit of zwart. Hiermee komt Niko tegemoet aan de trend van witte en zwarte gevels.

### VOORDELEN



#### Eenvoudig en snel

- mechanisme opbouw = mechanisme inbouw
  - de vertrouwde manier van werken
  - tijdswinst
  - geringe inbouwdiepte = meer ruimte voor bedrading
- verhoogde opbouwdoos
  - bedrading blijft binnen de opbouwdoos onder de sokkel
  - het vastgeklikte mechanisme wordt niet naar buiten geduwd
  - handenvrij monteren van het deksel



#### Betrouwbaar

- spuitwaterdicht: IP55
- slagvast: IK07
- hoge chemische bestendigheid
- onverliesbare schroeven
- mechanisme zit vast aan het deksel bij levering

#### Esthetisch

- mooie inbouwoplossing voor metselwerk en panelen
- membraaningangen voor de enkelvoudige en tweevoudige opbouwdoos
- sober en subtiel design
- volledig assortiment in grijs, zwart en wit: integreert harmonieus in de omgeving
- kleurvast: in de massa gekleurd



#### Functioneel

- aanpaskader om 45 x 45 mm Niko datamodules, telefooncontactdozen, audioaansluitingen en tv/FM-contactdozen in te bouwen
- schakelaars 16A, ledsignaalapparaat, fietsoplaspunt, sleutelschakelaar...

D.1

D.2

D.3

D.4

D.5

D.6



De meest recente informatie  
vind je op [www.niko.eu](http://www.niko.eu)





NIEUW

#### **Niko Hydro met insteekklemmen**

- klemvast dankzij de insteekklem van hoogstaande kwaliteit
- ontgrendeling vooraan, waardoor de bedrading de geleiders niet kan losduwen
- lange levensduur dankzij het doordachte productdesign
- compatibel met de Niko Hydro inbouwkaders en opbouwdozen



#### **Sleutelschakelaar**

- spuitwaterdicht: IP55
- zowel 10 A als 16 A: geschikt voor rolluiken, garagepoorten, toegangsdeuren, hekken, schermen, zwembadcovers en wandcontactdozen
- eenvoudige en intuïtieve bediening
- compatibel met de Niko Hydro inbouwkaders en opbouwdozen
- beschikbaar in grijs, zwart en wit



#### **Signaalapparaat met witte leds**

- spuitwaterdicht: IP55
- melkwitte lens en witte leds
- signaalfunctie en oriëntatieverlichting
- compatibel met de Niko Hydro inbouwkaders en opbouwdozen



#### **Fietsoplaadpunt**

- herkenbaar design met groen deksel en fietslogo
- standaard stroomsterkte: 16 A
- combineerbaar met de sleutelschakelaar 16 A
- compatibel met de Niko Hydro inbouwkaders en opbouwdozen
- beschikbaar in grijs, zwart en wit

D.1

D.2

D.3

D.4

D.5

D.6



De meest recente informatie  
vind je op [www.niko.eu](http://www.niko.eu)



NIEUW

### Fietsoplaadpunt, 16 A/250 Vac



Tweepolig met randaarde en kinderveiligheid.

De Niko Hydro producten zijn niet geschikt voor gebruik in ammoniakrijke omgevingen (bv. varkensstallen).

$$h \left| \begin{array}{l} 16 A \\ 250 Vac \end{array} \right.$$



#### VOLLEDIG APPARAAT MET INSTEKKLEMMEN, EXCLUSIEF DOOS (IP55)



|   |                  |           |                           |
|---|------------------|-----------|---------------------------|
|  | <b>700-36875</b> | Stuks: 10 | Met insteekklemmen, grey  |
|  | <b>701-36875</b> | Stuks: 10 | Met insteekklemmen, white |
|  | <b>761-36875</b> | Stuks: 10 | Met insteekklemmen, black |

#### VOLLEDIG APPARAAT MET SCHROEFKLEMMEN, EXCLUSIEF DOOS (IP55)



|   |                  |           |                           |
|---|------------------|-----------|---------------------------|
|  | <b>700-36870</b> | Stuks: 10 | Met schroefklemmen, grey  |
|  | <b>701-36870</b> | Stuks: 10 | Met schroefklemmen, white |
|  | <b>761-36870</b> | Stuks: 10 | Met schroefklemmen, black |



### Wandcontactdoos, 16 A/250 Vac



Tweepolig met randaarde en kinderveiligheid.

De Niko Hydro producten zijn niet geschikt voor gebruik in ammoniakrijke omgevingen (bv. varkensstallen).

$$h \left| \begin{array}{l} 16 A \\ 250 Vac \end{array} \right.$$



#### VOLLEDIG APPARAAT MET INSTEKKLEMMEN, EXCLUSIEF DOOS (IP55)



|   |                  |           |                           |
|---|------------------|-----------|---------------------------|
|  | <b>700-36805</b> | Stuks: 10 | Met insteekklemmen, grey  |
|  | <b>701-36805</b> | Stuks: 10 | Met insteekklemmen, white |
|  | <b>761-36805</b> | Stuks: 10 | Met insteekklemmen, black |

#### VOLLEDIG APPARAAT MET SCHROEFKLEMMEN, EXCLUSIEF DOOS (IP55)



|   |                  |           |                           |
|---|------------------|-----------|---------------------------|
|  | <b>700-36800</b> | Stuks: 10 | Met schroefklemmen, grey  |
|  | <b>701-36800</b> | Stuks: 10 | Met schroefklemmen, white |
|  | <b>761-36800</b> | Stuks: 10 | Met schroefklemmen, black |



### Wandcontactdoos, 16 A/250 Vac



Tweepolig met penaaarde en kinderveiligheid.

De Niko Hydro producten zijn niet geschikt voor gebruik in ammoniakrijke omgevingen (bv. varkensstallen).

$$h \left| \begin{array}{l} 16 A \\ 250 Vac \end{array} \right.$$



#### VOLLEDIG APPARAAT MET INSTEKKLEMMEN, EXCLUSIEF DOOS (IP55)



|   |                  |           |                           |
|---|------------------|-----------|---------------------------|
|  | <b>700-36605</b> | Stuks: 10 | Met insteekklemmen, grey  |
|  | <b>701-36605</b> | Stuks: 10 | Met insteekklemmen, white |
|  | <b>761-36605</b> | Stuks: 10 | Met insteekklemmen, black |

#### VOLLEDIG APPARAAT MET SCHROEFKLEMMEN, EXCLUSIEF DOOS (IP55)



|   |                  |           |                           |
|---|------------------|-----------|---------------------------|
|  | <b>700-36600</b> | Stuks: 10 | Met schroefklemmen, grey  |
|  | <b>701-36600</b> | Stuks: 10 | Met schroefklemmen, white |
|  | <b>761-36600</b> | Stuks: 10 | Met schroefklemmen, black |

**Dubbele wandcontactdoos, 16 A/250 VAC**



Tweepolig met randaarde en kinderveiligheid.

De Niko Hydro producten zijn niet geschikt voor gebruik in ammoniakrijke omgevingen (bv. varkensstallen).





16 A  
250 Vac

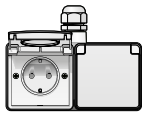

**VOLLEDIG APPARAAT, INCLUSIEF DOOS MET ÉÉN M20-INGANG (IP55), VOORBEDRAAD, INSTEKKLEMMEN, VERTICAAL**

|   |                  |          |   |
|---|------------------|----------|---|
|  | <b>700-37845</b> | Stuks: 3 | Met insteekklemmen en één M20-wartel, grey  |
|  | <b>701-37845</b> | Stuks: 3 | Met insteekklemmen en één M20-wartel, white |
|  | <b>761-37845</b> | Stuks: 3 | Met insteekklemmen en één M20-wartel, black |

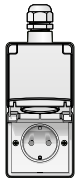

**VOLLEDIG APPARAAT, INCLUSIEF DOOS MET ÉÉN M20-INGANG (IP55), VOORBEDRAAD, INSTEKKLEMMEN, HORIZONTAAL**

|   |                  |          |   |
|---|------------------|----------|---|
|  | <b>700-37846</b> | Stuks: 2 | Met insteekklemmen en één M20-wartel, grey  |
|  | <b>701-37846</b> | Stuks: 2 | Met insteekklemmen en één M20-wartel, white |
|  | <b>761-37846</b> | Stuks: 2 | Met insteekklemmen en één M20-wartel, black |

**VOLLEDIG APPARAAT, INCLUSIEF DOOS MET ÉÉN M20-INGANG (IP55), VOORBEDRAAD, SCHROEFKLEMMEN, VERTICAAL**

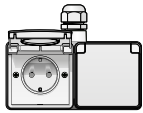
|   |                  |          |   |
|---|------------------|----------|---|
|  | <b>700-37842</b> | Stuks: 3 | Met schroefklemmen en één M20-wartel, grey  |
|  | <b>701-37842</b> | Stuks: 3 | Met schroefklemmen en één M20-wartel, white |
|  | <b>761-37842</b> | Stuks: 3 | Met schroefklemmen en één M20-wartel, black |

**VOLLEDIG APPARAAT, INCLUSIEF DOOS MET ÉÉN M20-INGANG (IP55), VOORBEDRAAD, SCHROEFKLEMMEN, HORIZONTAAL**

|   |                  |          |   |
|---|------------------|----------|---|
|  | <b>700-37848</b> | Stuks: 2 | Met schroefklemmen en één M20-wartel, grey  |
|  | <b>701-37848</b> | Stuks: 2 | Met schroefklemmen en één M20-wartel, white |
|  | <b>761-37848</b> | Stuks: 2 | Met schroefklemmen en één M20-wartel, black |



**Tweepolige schakelaar, 10 A/250 Vac**

De Niko Hydro producten zijn niet geschikt voor gebruik in ammoniakrijke omgevingen (bv. varkensstallen).





10 A  
250 Vac

**VOLLEDIG APPARAAT MET INSTEKKLEMMEN, EXCLUSIEF DOOS (IP55)**

|   |                  |           |                           |
|---|------------------|-----------|---------------------------|
|  | <b>700-31205</b> | Stuks: 10 | Met insteekklemmen, grey  |
|  | <b>701-31205</b> | Stuks: 10 | Met insteekklemmen, white |
|  | <b>761-31205</b> | Stuks: 10 | Met insteekklemmen, black |

**VOLLEDIG APPARAAT MET SCHROEFKLEMMEN, EXCLUSIEF DOOS (IP55)**

|   |                  |           |                           |
|---|------------------|-----------|---------------------------|
|  | <b>700-31200</b> | Stuks: 10 | Met schroefklemmen, grey  |
|  | <b>701-31200</b> | Stuks: 10 | Met schroefklemmen, white |
|  | <b>761-31200</b> | Stuks: 10 | Met schroefklemmen, black |

D.1

D.2

D.3

D.4

D.5

D.6



De meest recente informatie  
vind je op [www.niko.eu](http://www.niko.eu)



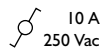

### Wisselschakelaar, 10 A/250 Vac

De Niko Hydro producten zijn niet geschikt voor gebruik in ammoniakrijke omgevingen (bv. varkensstallen).





#### VOLLEDIG APPARAAT MET INSTEKKLEMMEN, EXCLUSIEF DOOS (IP55)



|   |                  |           |                           |
|---|------------------|-----------|---------------------------|
|  | <b>700-31605</b> | Stuks: 10 | Met insteekklemmen, grey  |
|  | <b>701-31605</b> | Stuks: 10 | Met insteekklemmen, white |
|  | <b>761-31605</b> | Stuks: 10 | Met insteekklemmen, black |

#### VOLLEDIG APPARAAT MET SCHROEFKLEMMEN, EXCLUSIEF DOOS (IP55)



|   |                  |           |                           |
|---|------------------|-----------|---------------------------|
|  | <b>700-31600</b> | Stuks: 10 | Met schroefklemmen, grey  |
|  | <b>701-31600</b> | Stuks: 10 | Met schroefklemmen, white |
|  | <b>761-31600</b> | Stuks: 10 | Met schroefklemmen, black |





### Kruisschakelaar, 10 A/250 Vac

De Niko Hydro producten zijn niet geschikt voor gebruik in ammoniakrijke omgevingen (bv. varkensstallen).





#### VOLLEDIG APPARAAT MET INSTEKKLEMMEN, EXCLUSIEF DOOS (IP55)



|   |                  |           |                           |
|---|------------------|-----------|---------------------------|
|  | <b>700-31705</b> | Stuks: 10 | Met insteekklemmen, grey  |
|  | <b>701-31705</b> | Stuks: 10 | Met insteekklemmen, white |
|  | <b>761-31705</b> | Stuks: 10 | Met insteekklemmen, black |

#### VOLLEDIG APPARAAT MET SCHROEFKLEMMEN, EXCLUSIEF DOOS (IP55)



|   |                  |           |                           |
|---|------------------|-----------|---------------------------|
|  | <b>700-31700</b> | Stuks: 10 | Met schroefklemmen, grey  |
|  | <b>701-31700</b> | Stuks: 10 | Met schroefklemmen, white |
|  | <b>761-31700</b> | Stuks: 10 | Met schroefklemmen, black |





### Tweepolige schakelaar, 16 A/250 Vac

De Niko Hydro producten zijn niet geschikt voor gebruik in ammoniakrijke omgevingen (bv. varkensstallen).



#### VOLLEDIG APPARAAT MET SCHROEFKLEMMEN, EXCLUSIEF DOOS (IP55)





|   |                  |           |                           |
|---|------------------|-----------|---------------------------|
|  | <b>700-31300</b> | Stuks: 10 | Met schroefklemmen, grey  |
|  | <b>701-31300</b> | Stuks: 10 | Met schroefklemmen, white |
|  | <b>761-31300</b> | Stuks: 10 | Met schroefklemmen, black |

**Wisselschakelaar, 16 A/250 Vac**

De Niko Hydro producten zijn niet geschikt voor gebruik in ammoniakrijke omgevingen (bv. varkensstallen).



**VOLLEDIG APPARAAT MET SCHROEFKLEMMEN, EXCLUSIEF DOOS (IP55)**

|   |                  |           |                           |
|---|------------------|-----------|---------------------------|
|  | <b>700-31616</b> | Stuks: 10 | Met schroefklemmen, grey  |
|  | <b>701-31616</b> | Stuks: 10 | Met schroefklemmen, white |
|  | <b>761-31616</b> | Stuks: 10 | Met schroefklemmen, black |

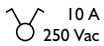

**Serieschakelaar, 10 A/250 Vac**

De Niko Hydro producten zijn niet geschikt voor gebruik in ammoniakrijke omgevingen (bv. varkensstallen).

**VOLLEDIG APPARAAT MET INSTEKKLEMMEN, EXCLUSIEF DOOS (IP55)**

|  |                  |           |                           |
|--|------------------|-----------|---------------------------|
|   | <b>700-31505</b> | Stuks: 10 | Met insteekklemmen, grey  |
|   | <b>701-31505</b> | Stuks: 10 | Met insteekklemmen, white |
|  | <b>761-31505</b> | Stuks: 10 | Met insteekklemmen, black |



**VOLLEDIG APPARAAT MET SCHROEFKLEMMEN, EXCLUSIEF DOOS (IP55)**

|   |                  |           |                           |
|---|------------------|-----------|---------------------------|
|  | <b>700-31500</b> | Stuks: 10 | Met schroefklemmen, grey  |
|  | <b>701-31500</b> | Stuks: 10 | Met schroefklemmen, white |
|  | <b>761-31500</b> | Stuks: 10 | Met schroefklemmen, black |

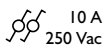

**Tweevoudige wisselschakelaar, 10 A/250 Vac**

De Niko Hydro producten zijn niet geschikt voor gebruik in ammoniakrijke omgevingen (bv. varkensstallen).

**VOLLEDIG APPARAAT MET INSTEKKLEMMEN, EXCLUSIEF DOOS (IP55)**

|   |                  |           |                           |
|---|------------------|-----------|---------------------------|
|  | <b>700-32605</b> | Stuks: 10 | Met insteekklemmen, grey  |
|  | <b>701-32605</b> | Stuks: 10 | Met insteekklemmen, white |
|  | <b>761-32605</b> | Stuks: 10 | Met insteekklemmen, black |

**VOLLEDIG APPARAAT MET SCHROEFKLEMMEN, EXCLUSIEF DOOS (IP55)**

|   |                  |           |                           |
|---|------------------|-----------|---------------------------|
|  | <b>700-32600</b> | Stuks: 10 | Met schroefklemmen, grey  |
|  | <b>701-32600</b> | Stuks: 10 | Met schroefklemmen, white |
|  | <b>761-32600</b> | Stuks: 10 | Met schroefklemmen, black |

D.1

D.2

D.3

D.4

D.5

D.6



De meest recente informatie  
vind je op [www.niko.eu](http://www.niko.eu)





### Tweepolige controleschakelaar, 10 A/250 Vac

Met transparant venstertje zonder symbool. Het ledverlichtingselement moet afzonderlijk worden besteld (zie accessoires).  
De Niko Hydro producten zijn niet geschikt voor gebruik in ammoniakrijke omgevingen (bv. varkensstallen).





#### VOLLEDIG APPARAAT MET INSTEKKLEMMEN, EXCLUSIEF DOOS (IP55)



|   |                  |           |                           |
|---|------------------|-----------|---------------------------|
|  | <b>700-37205</b> | Stuks: 10 | Met insteekklemmen, grey  |
|  | <b>701-37205</b> | Stuks: 10 | Met insteekklemmen, white |
|  | <b>761-37205</b> | Stuks: 10 | Met insteekklemmen, black |

#### VOLLEDIG APPARAAT MET SCHROEFKLEMMEN, EXCLUSIEF DOOS (IP55)



|   |                  |           |                           |
|---|------------------|-----------|---------------------------|
|  | <b>700-37200</b> | Stuks: 10 | Met schroefklemmen, grey  |
|  | <b>701-37200</b> | Stuks: 10 | Met schroefklemmen, white |
|  | <b>761-37200</b> | Stuks: 10 | Met schroefklemmen, black |





### Wisselcontrolschakelaar, 10 A/250 Vac

Met transparant venstertje zonder symbool. Het ledverlichtingselement moet afzonderlijk worden besteld (zie accessoires).  
De Niko Hydro producten zijn niet geschikt voor gebruik in ammoniakrijke omgevingen (bv. varkensstallen).





#### VOLLEDIG APPARAAT MET INSTEKKLEMMEN, EXCLUSIEF DOOS (IP55)



|   |                  |           |                           |
|---|------------------|-----------|---------------------------|
|  | <b>700-37605</b> | Stuks: 10 | Met insteekklemmen, grey  |
|  | <b>701-37605</b> | Stuks: 10 | Met insteekklemmen, white |
|  | <b>761-37605</b> | Stuks: 10 | Met insteekklemmen, black |

#### VOLLEDIG APPARAAT MET SCHROEFKLEMMEN, EXCLUSIEF DOOS (IP55)



|   |                  |           |                           |
|---|------------------|-----------|---------------------------|
|  | <b>700-37600</b> | Stuks: 10 | Met schroefklemmen, grey  |
|  | <b>701-37600</b> | Stuks: 10 | Met schroefklemmen, white |
|  | <b>761-37600</b> | Stuks: 10 | Met schroefklemmen, black |



### Sleutelschakelaar 10 A/250 Vac

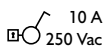

Met deze spuitwaterdichte sleutelschakelaar open en sluit je eenvoudig elektrische schuifdeuren, hekken, zwembadoverdekkingen ...  
De Niko Hydro producten zijn niet geschikt voor gebruik in ammoniakrijke omgevingen (bv. varkensstallen).



NIEUW

#### VOLLEDIG APPARAAT MET SCHROEFKLEMMEN, EXCLUSIEF DOOS (IP55)



|   |                  |           |                          |
|---|------------------|-----------|--------------------------|
|  | <b>700-38700</b> | Stuks: 10 | Sleutelschakelaar, grey  |
|  | <b>701-38700</b> | Stuks: 10 | Sleutelschakelaar, white |
|  | <b>761-38700</b> | Stuks: 10 | Sleutelschakelaar, black |



### Sleutelschakelaar 16 A/250 Vac

Met deze spuitwaterdichte sleutelschakelaar open en sluit je eenvoudig elektrische schuifdeuren, hekken, zwembadoverdekkingen ... De Niko Hydro producten zijn niet geschikt voor gebruik in ammoniakrijke omgevingen (bv. varkensstallen).



 16 A  
250 Vac



NIEUW

#### VOLLEDIG APPARAAT MET SCHROEFKLEMMEN, EXCLUSIEF DOOS (IP55)



|   |                  |          |                               |
|---|------------------|----------|-------------------------------|
|  | <b>700-38800</b> | Stuks: 6 | Sleutelschakelaar 16 A, grey  |
|  | <b>701-38800</b> | Stuks: 6 | Sleutelschakelaar 16 A, white |
|  | <b>761-38800</b> | Stuks: 6 | Sleutelschakelaar 16 A, black |

### Rolluikschakelaar, mechanisch vergrendeld en elektrisch gescheiden

Deze schakelaar wordt gebruikt om de motoren te bedienen van onder meer rolluiken, garagepoorten, jaloezieën en markiezen.

Als je de draairichting wil veranderen, moet je eerst de linkertoets op 'STOP' plaatsen, dan op het juiste pijltje drukken op de rechertoets en vervolgens opnieuw op 'START' drukken.



De Niko Hydro producten zijn niet geschikt voor gebruik in ammoniakrijke omgevingen (bv. varkensstallen).



 10 A  
250 Vac



#### VOLLEDIG APPARAAT MET INSTEKKLEMMEN, EXCLUSIEF DOOS (IP55)



|   |                  |           |                           |
|---|------------------|-----------|---------------------------|
|  | <b>700-35905</b> | Stuks: 10 | Met insteekklemmen, grey  |
|  | <b>701-35905</b> | Stuks: 10 | Met insteekklemmen, white |
|  | <b>761-35905</b> | Stuks: 10 | Met insteekklemmen, black |

#### VOLLEDIG APPARAAT MET SCHROEFKLEMMEN, EXCLUSIEF DOOS (IP55)



|   |                  |           |                           |
|---|------------------|-----------|---------------------------|
|  | <b>700-35900</b> | Stuks: 10 | Met schroefklemmen, grey  |
|  | <b>701-35900</b> | Stuks: 10 | Met schroefklemmen, white |
|  | <b>761-35900</b> | Stuks: 10 | Met schroefklemmen, black |

### Rolluikdrukknop, elektrisch gescheiden

Deze drukknop wordt gebruikt om de motoren te bedienen van onder meer rolluiken, garagepoorten, jaloezieën en markiezen.



De Niko Hydro producten zijn niet geschikt voor gebruik in ammoniakrijke omgevingen (bv. varkensstallen).

 10 A  
250 Vac





#### VOLLEDIG APPARAAT MET INSTEKKLEMMEN, EXCLUSIEF DOOS (IP55)



|   |                  |           |                           |
|---|------------------|-----------|---------------------------|
|  | <b>700-35915</b> | Stuks: 10 | Met insteekklemmen, grey  |
|  | <b>701-35915</b> | Stuks: 10 | Met insteekklemmen, white |
|  | <b>761-35915</b> | Stuks: 10 | Met insteekklemmen, black |

#### VOLLEDIG APPARAAT MET SCHROEFKLEMMEN, EXCLUSIEF DOOS (IP55)



|   |                  |           |                           |
|---|------------------|-----------|---------------------------|
|  | <b>700-35910</b> | Stuks: 10 | Met schroefklemmen, grey  |
|  | <b>701-35910</b> | Stuks: 10 | Met schroefklemmen, white |
|  | <b>761-35910</b> | Stuks: 10 | Met schroefklemmen, black |

D.1

D.2

D.3

D.4

D.5

D.6



De meest recente informatie  
vind je op [www.niko.eu](http://www.niko.eu)





### Verlichtbare drukknop, NO of NG

Met transparant venstertje zonder symbool. Het ledverlichtingselement moet afzonderlijk worden besteld (zie accessoires). De Niko Hydro producten zijn niet geschikt voor gebruik in ammoniakrijke omgevingen (bv. varkensstallen).

⊗ 10 A  
250 Vac



#### VOLLEDIG APPARAAT MET INSTEKKLEMMEN, EXCLUSIEF DOOS (IP55)



|   |                  |           |                           |
|---|------------------|-----------|---------------------------|
|  | <b>700-30005</b> | Stuks: 10 | Met insteekklemmen, grey  |
|  | <b>701-30005</b> | Stuks: 10 | Met insteekklemmen, white |
|  | <b>761-30005</b> | Stuks: 10 | Met insteekklemmen, black |

#### VOLLEDIG APPARAAT MET SCHROEFKLEMMEN, EXCLUSIEF DOOS (IP55)



|   |                  |           |                           |
|---|------------------|-----------|---------------------------|
|  | <b>700-30000</b> | Stuks: 10 | Met schroefklemmen, grey  |
|  | <b>701-30000</b> | Stuks: 10 | Met schroefklemmen, white |
|  | <b>761-30000</b> | Stuks: 10 | Met schroefklemmen, black |





### Niet-verlichtbare drukknop, NO of NG

Met vier aansluitklemmen

⊙ 10 A  
250 Vac



#### VOLLEDIG APPARAAT MET INSTEKKLEMMEN, EXCLUSIEF DOOS (IP55)



|   |                  |           |                           |
|---|------------------|-----------|---------------------------|
|  | <b>700-33005</b> | Stuks: 10 | Met insteekklemmen, grey  |
|  | <b>701-33005</b> | Stuks: 10 | Met insteekklemmen, white |
|  | <b>761-33005</b> | Stuks: 10 | Met insteekklemmen, black |

#### VOLLEDIG APPARAAT MET SCHROEFKLEMMEN, EXCLUSIEF DOOS (IP55)



|   |                  |           |                           |
|---|------------------|-----------|---------------------------|
|  | <b>700-33000</b> | Stuks: 10 | Met schroefklemmen, grey  |
|  | <b>701-33000</b> | Stuks: 10 | Met schroefklemmen, white |
|  | <b>761-33000</b> | Stuks: 10 | Met schroefklemmen, black |





### Verlichtbare tweevoudige drukknop, 2x NO of NG

Met transparante venstertjes zonder symbool. De ledverlichtingselementen moeten afzonderlijk worden besteld (zie accessoires). De Niko Hydro producten zijn niet geschikt voor gebruik in ammoniakrijke omgevingen (bv. varkensstallen).

⊗⊗ 10 A  
250 Vac



#### VOLLEDIG APPARAAT MET INSTEKKLEMMEN, EXCLUSIEF DOOS (IP55)



|   |                  |           |                           |
|---|------------------|-----------|---------------------------|
|  | <b>700-35105</b> | Stuks: 10 | Met insteekklemmen, grey  |
|  | <b>701-35105</b> | Stuks: 10 | Met insteekklemmen, white |
|  | <b>761-35105</b> | Stuks: 10 | Met insteekklemmen, black |

#### VOLLEDIG APPARAAT MET SCHROEFKLEMMEN, EXCLUSIEF DOOS (IP55)





|   |                  |           |                           |
|---|------------------|-----------|---------------------------|
|  | <b>700-35100</b> | Stuks: 10 | Met schroefklemmen, grey  |
|  | <b>701-35100</b> | Stuks: 10 | Met schroefklemmen, white |
|  | <b>761-35100</b> | Stuks: 10 | Met schroefklemmen, black |

**Niet-verlichtbare tweevoudige drukknop, 2x NO of NG**

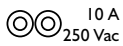

De Niko Hydro producten zijn niet geschikt voor gebruik in ammoniakrijke omgevingen (bv. varkensstallen).

 10 A  
250 Vac

**VOLLEDIG APPARAAT MET INSTEKKLEMMEN, EXCLUSIEF DOOS (IP55)**

|   |                  |           |                           |
|---|------------------|-----------|---------------------------|
|  | <b>700-35005</b> | Stuks: 10 | Met insteekklemmen, grey  |
|  | <b>701-35005</b> | Stuks: 10 | Met insteekklemmen, white |
|  | <b>761-35005</b> | Stuks: 10 | Met insteekklemmen, black |

**VOLLEDIG APPARAAT MET SCHROEFKLEMMEN, EXCLUSIEF DOOS (IP55)**

|   |                  |           |                           |
|---|------------------|-----------|---------------------------|
|  | <b>700-35000</b> | Stuks: 10 | Met schroefklemmen, grey  |
|  | <b>701-35000</b> | Stuks: 10 | Met schroefklemmen, white |
|  | <b>761-35000</b> | Stuks: 10 | Met schroefklemmen, black |

**Transparant venstertje met symbolen voor drukknoppen (10 A/250 Vac)****TRANSPARANTE VENSTERTJES**

**700-30100** Stuks: 10 Met belymbol



**700-30200** Stuks: 10 Met lampsymbool



**700-30300** Stuks: 10 Met sleutelsymbool

D.1

D.2

D.3

D.4

D.5

D.6

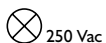

**Signaalapparaat, 250 Vac**

Met transparant deksel met rode of witte leds.

 250 Vac

**VOLLEDIG APPARAAT, EXCLUSIEF DOOS (IP55)**



**NIEUW**

|   |                  |           |                                  |
|---|------------------|-----------|----------------------------------|
|  | <b>700-38100</b> | Stuks: 10 | Met schroefklemmen en rode leds  |
|  | <b>700-38200</b> | Stuks: 10 | Met schroefklemmen en witte leds |

**Aanpaskader met klapdeksel voor 45x45 mm-functies**

Aanpaskader voor de inbouw van de volgende 45x45 mm-functies: Niko datamodules, telefooncontactdozen, audioaansluitingen en tv-FM-contactdozen.

**VOLLEDIG APPARAAT, EXCLUSIEF DOOS (IP55)**

|   |                  |           |       |
|---|------------------|-----------|-------|
|  | <b>700-85000</b> | Stuks: 10 | Grey  |
|  | <b>701-85000</b> | Stuks: 10 | White |
|  | <b>761-85000</b> | Stuks: 10 | Black |



De meest recente informatie  
vind je op [www.niko.eu](http://www.niko.eu)



**Datamodule voor Niko RJ-connectoren**

enkelvoudige datamodule (vlak) = 1 enkelvoudige afwerkingsset + 1 passtuk  
 tweevoudige datamodule (vlak) = 1 tweevoudige afwerkingsset + 2 passtukken  
 tweevoudige datamodule (schuin) = 1 tweevoudige afwerkingsset + 1 passtuk

**PASSTUKKEN VOOR VLAKKE UITVOERING VOOR NIKO CONNECTOREN 650-450XX, ENKELVOUDIG**



**170-65901** Stuks: 10 Enkelvoudig passtuk 9.1















**PASSTUKKEN VOOR SCHUINE UITVOERING VOOR NIKO CONNECTOREN 650-450XX, DUBBEL**



**170-65904** Stuks: 10 Tweevoudig schuin passtuk 9.4















**AFWERKINGSSET MET ONDOORZICHTIG TEKSTVELD**



|   |                  |           |   |                  |           |   |                  |           |
|---|------------------|-----------|---|------------------|-----------|---|------------------|-----------|
|  | <b>100-65100</b> | Stuks: 10 |  | <b>101-65100</b> | Stuks: 10 |  | <b>102-65100</b> | Stuks: 10 |
|  | <b>104-65100</b> | Stuks: 10 |  | <b>121-65100</b> | Stuks: 10 |  | <b>122-65100</b> | Stuks: 10 |
|  | <b>123-65100</b> | Stuks: 10 |  | <b>124-65100</b> | Stuks: 10 |  | <b>154-65100</b> | Stuks: 10 |
|  | <b>157-65100</b> | Stuks: 10 |  | <b>161-65100</b> | Stuks: 10 |  | <b>200-65100</b> | Stuks: 10 |
|  | <b>220-65100</b> | Stuks: 10 |  | <b>221-65100</b> | Stuks: 10 |   |                  |           |

**AFWERKINGSSET MET ONDOORZICHTIG TEKSTVELD**



|   |                  |           |   |                  |           |   |                  |           |
|---|------------------|-----------|---|------------------|-----------|---|------------------|-----------|
|    | <b>100-65200</b> | Stuks: 10 |    | <b>101-65200</b> | Stuks: 10 |    | <b>111-65200</b> | Stuks: 10 |
|   | <b>102-65200</b> | Stuks: 10 |   | <b>104-65200</b> | Stuks: 10 |   | <b>121-65200</b> | Stuks: 10 |
|  | <b>122-65200</b> | Stuks: 10 |  | <b>123-65200</b> | Stuks: 10 |  | <b>124-65200</b> | Stuks: 10 |
|  | <b>154-65200</b> | Stuks: 10 |  | <b>157-65200</b> | Stuks: 10 |  | <b>161-65200</b> | Stuks: 10 |
|  | <b>200-65200</b> | Stuks: 10 |  | <b>220-65200</b> | Stuks: 10 |  | <b>221-65200</b> | Stuks: 10 |

**STANDAARD 45X45 MM-MODULE, VLAK**



**101-65500** Stuks: 10 Enkelvoudige afwerkingsset met transparant tekstveld















**STANDAARD 45X45 MM-MODULE, VLAK**



**101-65600** Stuks: 10 Tweevoudige afwerkingsset met transparant tekstveld

**AFWERKINGSSET MET TRANSPARANT TEKSTVELD, SCHUIN**



|   |                  |           |   |                  |           |   |                  |           |
|---|------------------|-----------|---|------------------|-----------|---|------------------|-----------|
|  | <b>100-65400</b> | Stuks: 10 |  | <b>101-65400</b> | Stuks: 10 |  | <b>102-65400</b> | Stuks: 10 |
|  | <b>104-65400</b> | Stuks: 10 |  | <b>121-65400</b> | Stuks: 10 |  | <b>122-65400</b> | Stuks: 10 |
|  | <b>123-65400</b> | Stuks: 10 |  | <b>124-65400</b> | Stuks: 10 |  | <b>154-65400</b> | Stuks: 10 |
|  | <b>157-65400</b> | Stuks: 10 |  | <b>161-65400</b> | Stuks: 10 |  | <b>200-65400</b> | Stuks: 10 |
|  | <b>220-65400</b> | Stuks: 10 |  | <b>221-65400</b> | Stuks: 10 |   |                  |           |

## Niko RJ-connector



## CONNECTOREN

|  |                        |           |                              |
|--|------------------------|-----------|------------------------------|
|  | <b>650-45051</b>       | Stuks: 10 | RJ45-connector, UTP, cat. 5E |
|  | <b>650-45055</b>       | Stuks: 10 | RJ45-connector, STP, cat. 5E |
|  | <b>650-45061</b>       | Stuks: 10 | RJ45-connector, UTP, cat. 6  |
|  | <b>650-45066</b>       | Stuks: 10 | RJ45-connector, STP, cat. 6  |
|  | <b>650-45013</b>       | Stuks: 10 | RJ11-connector, UTP          |
|  | <b>NIEUW 650-45071</b> | Stuks: 10 | RJ45-connector, UTP, cat.6 A |
|  | <b>NIEUW 650-45077</b> | Stuks: 10 | RJ45-connector, STP, cat.6 A |

## Enkelvoudige datamodule voor andere RJ-connectoren

datamodule = 1 afwerkingsset + 1 passtuk

Raadpleeg ook de tabel "Datacomaansluitingen voor andere RJ-connectoren" in het hoofdstuk "Medianetwerk".



D.1  
D.2  
D.3  
D.4  
D.5  
D.6

## PASSTUKKEN VOOR VLAKKE UITVOERING VOOR ANDERE MERKEN, ENKELVOUDIG

|  |                  |           |   |
|--|------------------|-----------|---|
|  | <b>170-65101</b> | Stuks: 10 | Enkelvoudig passtuk 1 (voor AMP, Siemon, Nexans, Brandrex,...)                          |
|  | <b>170-65201</b> | Stuks: 10 | Enkelvoudig passtuk 2 (voor systemax,...)   |
|  | <b>170-65501</b> | Stuks: 10 | Enkelvoudig passtuk 5 (voor Krone, Kerpen, Radiall, Gigamedia,...)                      |
|  | <b>170-65601</b> | Stuks: 10 | Enkelvoudig passtuk 6 (voor Panduit,...)  |
|  | <b>170-65701</b> | Stuks: 10 | Enkelvoudig passtuk 7 (voor CAE, Multimedia Connect/MMC, Abitana, Prys-mian, Molex,...) |

## PASSTUKKEN VOOR VLAKKE UITVOERING VOOR OUDE NIKO CONNECTOREN 02-399-XX, ENKELVOUDIG

|  |                  |           |                         |
|--|------------------|-----------|-------------------------|
|  | <b>170-65401</b> | Stuks: 10 | Enkelvoudig passtuk 4.1 |
|--|------------------|-----------|-------------------------|

## AFWERKINGSSET MET ONDOORZICHTIG TEKSTVELD

|  |                  |           |                  |           |                  |           |
|--|------------------|-----------|------------------|-----------|------------------|-----------|
|  | <b>100-65100</b> | Stuks: 10 | <b>101-65100</b> | Stuks: 10 | <b>102-65100</b> | Stuks: 10 |
|  | <b>104-65100</b> | Stuks: 10 | <b>121-65100</b> | Stuks: 10 | <b>122-65100</b> | Stuks: 10 |
|  | <b>123-65100</b> | Stuks: 10 | <b>124-65100</b> | Stuks: 10 | <b>154-65100</b> | Stuks: 10 |
|  | <b>157-65100</b> | Stuks: 10 | <b>161-65100</b> | Stuks: 10 | <b>200-65100</b> | Stuks: 10 |
|  | <b>220-65100</b> | Stuks: 10 | <b>221-65100</b> | Stuks: 10 |                  |           |

## STANDAARD 45X45 MM-MODULE, VLAK

|  |                  |           |  |
|--|------------------|-----------|--|
|  | <b>101-65500</b> | Stuks: 10 | Enkelvoudige afwerkingsset met transparant tekstveld |
|--|------------------|-----------|--|



De meest recente informatie vind je op [www.niko.eu](http://www.niko.eu)



### Tweevoudige datamodule voor andere RJ-connectoren

datamodule = 1 afwerkingsset + 2 enkelvoudige passtukken of 1 tweevoudig passtuk

Raadpleeg ook de tabel "Datacomaansluitingen voor andere RJ-connectoren" in het hoofdstuk "Medianetwerk".

#### PASSTUKKEN VOOR VLAKKE UITVOERING VOOR ANDERE MERKEN, ENKELVOUDIG



**170-65101** Stuks: 10 Enkelvoudig passtuk 1 (voor AMP, Siemon, Nexans, Brandrex,...)



**170-65201** Stuks: 10 Enkelvoudig passtuk 2 (voor systimax,...)



**170-65501** Stuks: 10 Enkelvoudig passtuk 5 (voor Krone, Kerpen, Radiall, Gigamedia,...)



**170-65601** Stuks: 10 Enkelvoudig passtuk 6 (voor Panduit,...)



**170-65701** Stuks: 10 Enkelvoudig passtuk 7 (voor CAE, Multimedia Connect/MMC, Abitana, Prys-mian, Molex,...)

#### PASSTUKKEN VOOR VLAKKE UITVOERING VOOR ANDERE MERKEN, DUBBEL



**170-65302** Stuks: 10 Tweevoudig passtuk 3.2

#### PASSTUKKEN VOOR VLAKKE UITVOERING VOOR OUDE NIKO CONNECTOREN 02-399-XX, DUBBEL



**170-65402** Stuks: 10 Tweevoudig passtuk 4.2

#### AFWERKINGSSET MET ONDOORZICHTIG TEKSTVELD



**100-65200** Stuks: 10  
**102-65200** Stuks: 10  
**122-65200** Stuks: 10  
**154-65200** Stuks: 10  
**200-65200** Stuks: 10

**101-65200** Stuks: 10  
**104-65200** Stuks: 10  
**123-65200** Stuks: 10  
**157-65200** Stuks: 10  
**220-65200** Stuks: 10

**111-65200** Stuks: 10  
**121-65200** Stuks: 10  
**124-65200** Stuks: 10  
**161-65200** Stuks: 10  
**221-65200** Stuks: 10

#### STANDAARD 45X45 MM-MODULE, VLAK



**101-65600** Stuks: 10 Tweevoudige afwerkingsset met transparant tekstveld



### Telefooncontactdoos, 45 x 45 mm

#### VOLLEDIG APPARAAT



**101-69032** Stuks: 10 Telefooncontactdoos met twee RJ11-connectoren in parallel



**101-69092** Stuks: 10 ADSL-VDSL-splitter met twee RJ11-connectoren

**Audioaansluiting, 45 x 45 mm****VOLLEDIG APPARAAT**

**101-69703** Stuks: 10 Tweevoudige luidsprekeraansluiting



**101-69803** Stuks: 10 Enkelvoudige luidsprekeraansluiting

**TV-FM-contactdoos, 45 x 45 mm****VOLLEDIG APPARAAT**

**101-69121** Stuks: 10 Enkelvoudige contactdoos met coxaansluiting voor tv



**101-69501** Stuks: 10 Enkelvoudige contactdoos met coxaansluiting voor tv en FM



**101-69552** Stuks: 10 Enkelvoudige contactdoos met coxaansluiting voor tv, FM en satelliet



**101-69601** Stuks: 10 Doorluscontactdoos met coxaansluiting voor tv en FM

D.1

D.2

D.3

D.4

D.5

D.6







### Opbouwdoos voor één functie

Deze enkelvoudige opbouwdoos is geschikt voor het inbouwen van één functie. Het geheel is spuitwaterdicht wat het uitermate geschikt maakt voor gebruik in vochtige ruimtes en veeleisende omgevingen.



#### OPBOUWDOOS MET TWEE MEMBRAANINGANGEN



|   |                  |           |                          |
|---|------------------|-----------|--------------------------|
|  | <b>700-83101</b> | Stuks: 10 | Enkelvoudige doos, grey  |
|  | <b>701-83101</b> | Stuks: 10 | Enkelvoudige doos, white |
|  | <b>761-83101</b> | Stuks: 10 | Enkelvoudige doos, black |

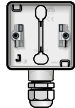

#### OPBOUWDOOS MET 1 M20-INGANG INCLUSIEF WARTEL



|   |                  |          |  |
|---|------------------|----------|--|
|  | <b>700-84151</b> | Stuks: 8 | Enkelvoudige doos met één M20-ingang inclusief M20-wartel, grey  |
|  | <b>701-84151</b> | Stuks: 8 | Enkelvoudige doos met één M20-ingang inclusief M20-wartel, white |
|  | <b>761-84151</b> | Stuks: 8 | Enkelvoudige doos met één M20-ingang inclusief M20-wartel, black |



#### OPBOUWDOOS MET 1X2 M20-INGANGEN INCLUSIEF WARTELS



|   |                  |          |   |
|---|------------------|----------|---|
|  | <b>700-84152</b> | Stuks: 8 | Enkelvoudige doos met 1x twee M20-ingangen inclusief M20-wartels, grey  |
|  | <b>701-84152</b> | Stuks: 8 | Enkelvoudige doos met 1x twee M20-ingangen inclusief M20-wartels, white |
|  | <b>761-84152</b> | Stuks: 8 | Enkelvoudige doos met 1x twee M20-ingangen inclusief M20-wartels, black |



#### OPBOUWDOOS MET 2X1 M20-INGANGEN INCLUSIEF WARTELS



|   |                  |          |  |
|---|------------------|----------|--|
|    | <b>700-84161</b> | Stuks: 5 | Enkelvoudige doos met 2x één M20-ingang inclusief M20-wartels, grey  |
|   | <b>701-84161</b> | Stuks: 5 | Enkelvoudige doos met 2x één M20-ingang inclusief M20-wartels, white |
|  | <b>761-84161</b> | Stuks: 5 | Enkelvoudige doos met 2x één M20-ingang inclusief M20-wartels, black |

#### OPBOUWDOOS MET 2+1 M20-INGANGEN INCLUSIEF WARTELS



|   |                  |          |   |
|---|------------------|----------|---|
|  | <b>700-84162</b> | Stuks: 5 | Enkelvoudige doos met 1x twee M20-ingangen en één M20-ingang, grey  |
|  | <b>701-84162</b> | Stuks: 5 | Enkelvoudige doos met 1x twee M20-ingangen en één M20-ingang, white |
|  | <b>761-84162</b> | Stuks: 5 | Enkelvoudige doos met 1x twee M20-ingangen en één M20-ingang, black |





## Verticale opbouwdoos voor twee functies

Deze dubbele verticale opbouwdoos is geschikt voor het inbouwen van twee functies. Het geheel is spuitwaterdicht wat het uitermate geschikt maakt voor gebruik in vochtige ruimtes en veeleisende omgevingen.





### VERTICALE OPBOUWDOOS MET TWEE MEMBRAANINGANGEN



|   |                  |          |                         |
|---|------------------|----------|-------------------------|
|  | <b>700-83201</b> | Stuks: 5 | Tweevoudige doos, grey  |
|  | <b>701-83201</b> | Stuks: 5 | Tweevoudige doos, white |
|  | <b>761-83201</b> | Stuks: 5 | Tweevoudige doos, black |



### VERTICALE OPBOUWDOOS MET 1 M20-INGANG INCLUSIEF WARTEL



|   |                  |          |   |
|---|------------------|----------|---|
|  | <b>700-84251</b> | Stuks: 5 | Tweevoudige doos met één M20-ingang inclusief M20-wartel, grey  |
|  | <b>701-84251</b> | Stuks: 5 | Tweevoudige doos met één M20-ingang inclusief M20-wartel, white |
|  | <b>761-84251</b> | Stuks: 5 | Tweevoudige doos met één M20-ingang inclusief M20-wartel, black |



### VERTICALE OPBOUWDOOS MET 1X2 M20-INGANGEN INCLUSIEF WARTELS



|   |                  |          |  |
|---|------------------|----------|--|
|    | <b>700-84252</b> | Stuks: 5 | Tweevoudige doos met 1x twee M20-ingangen inclusief M20-wartels, grey  |
|    | <b>701-84252</b> | Stuks: 5 | Tweevoudige doos met 1x twee M20-ingangen inclusief M20-wartels, white |
|  | <b>761-84252</b> | Stuks: 5 | Tweevoudige doos met 1x twee M20-ingangen inclusief M20-wartels, black |



### VERTICALE OPBOUWDOOS MET 2X1 M20-INGANGEN INCLUSIEF WARTELS



|   |                  |          |   |
|---|------------------|----------|---|
|  | <b>700-84261</b> | Stuks: 4 | Tweevoudige doos met 2x één M20-ingang inclusief M20-wartels, grey  |
|  | <b>701-84261</b> | Stuks: 4 | Tweevoudige doos met 2x één M20-ingang inclusief M20-wartels, white |
|  | <b>761-84261</b> | Stuks: 4 | Tweevoudige doos met 2x één M20-ingang inclusief M20-wartels, black |

### VERTICALE OPBOUWDOOS MET 2+1 M20-INGANGEN INCLUSIEF WARTELS



|   |                  |          |  |
|---|------------------|----------|--|
|  | <b>700-84262</b> | Stuks: 4 | Tweevoudige doos met 1x twee M20-ingangen en één M20-ingang, grey  |
|  | <b>701-84262</b> | Stuks: 4 | Tweevoudige doos met 1x twee M20-ingangen en één M20-ingang, white |
|  | <b>761-84262</b> | Stuks: 4 | Tweevoudige doos met 1x twee M20-ingangen en één M20-ingang, black |

D.1

D.2

D.3

D.4

D.5

D.6





### Horizontale opbouwdoos voor twee functies

Deze dubbele horizontale opbouwdoos is geschikt voor het inbouwen van twee functies. Het geheel is spuitwaterdicht wat het uitermate geschikt maakt voor gebruik in vochtige ruimtes en veeleisende omgevingen.

#### HORIZONTALE OPBOUWDOOS MET 1 M20-INGANG MET WARTEL

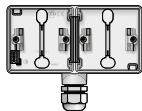

|  |                  |          |   |
|--|------------------|----------|---|
|  | <b>700-84851</b> | Stuks: 4 | Tweevoudige doos met één M20-ingang inclusief M20-wartel, grey  |
|  | <b>701-84851</b> | Stuks: 4 | Tweevoudige doos met één M20-ingang inclusief M20-wartel, white |
|  | <b>761-84851</b> | Stuks: 4 | Tweevoudige doos met één M20-ingang inclusief M20-wartel, black |

#### HORIZONTALE OPBOUWDOOS MET 1X2 M20-INGANGEN MET WARTELS

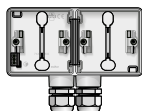

|  |                  |          |   |
|--|------------------|----------|---|
|  | <b>700-84852</b> | Stuks: 4 | Tweevoudige doos met 1 x twee M20-ingangen inclusief M20-wartels, grey  |
|  | <b>701-84852</b> | Stuks: 4 | Tweevoudige doos met 1 x twee M20-ingangen inclusief M20-wartels, white |
|  | <b>761-84852</b> | Stuks: 4 | Tweevoudige doos met 1 x twee M20-ingangen inclusief M20-wartels, black |



### Verticale opbouwdoos voor drie functies

Deze drievoudige verticale opbouwdoos met twee M20-ingangen is geschikt voor het inbouwen van drie functies. Het geheel is spuitwaterdicht wat het uitermate geschikt maakt voor gebruik in vochtige ruimtes en veeleisende omgevingen.

#### VERTICALE OPBOUWDOOS MET 1X2 M20-INGANGEN MET WARTELS



|  |                  |          |   |
|--|------------------|----------|---|
|  | <b>700-84352</b> | Stuks: 3 | Drievoudige doos met 1 x twee M20-ingangen inclusief M20-wartels, grey  |
|  | <b>701-84352</b> | Stuks: 3 | Drievoudige doos met 1 x twee M20-ingangen inclusief M20-wartels, white |
|  | <b>761-84352</b> | Stuks: 3 | Drievoudige doos met 1 x twee M20-ingangen inclusief M20-wartels, black |



### Horizontale opbouwdoos voor drie functies

Deze drievoudige horizontale opbouwdoos met twee M20-ingangen is geschikt voor het inbouwen van drie functies. Het geheel is spuitwaterdicht wat het uitermate geschikt maakt voor gebruik in vochtige ruimtes en veeleisende omgevingen.

#### HORIZONTALE OPBOUWDOOS MET 1X2 M20-INGANGEN MET WARTELS



|  |                  |          |   |
|--|------------------|----------|---|
|  | <b>700-84952</b> | Stuks: 3 | Drievoudige doos met 1 x twee M20-ingangen inclusief M20-wartels, grey  |
|  | <b>701-84952</b> | Stuks: 3 | Drievoudige doos met 1 x twee M20-ingangen inclusief M20-wartels, white |
|  | <b>761-84952</b> | Stuks: 3 | Drievoudige doos met 1 x twee M20-ingangen inclusief M20-wartels, black |



## inbouwkader

Voor de inbouw van één spuitwaterdichte opbouwfunctie in metselwerk of panelen.



### VOLLEDIG APPARAAT (IP55)



|   |                  |          |                                |
|---|------------------|----------|--------------------------------|
|  | <b>700-73000</b> | Stuks: 6 | Enkelvoudig inbouwkader, grey  |
|  | <b>701-73000</b> | Stuks: 6 | Enkelvoudig inbouwkader, white |
|  | <b>761-73000</b> | Stuks: 6 | Enkelvoudig inbouwkader, black |

### TOEBEHOREN



**170-00093** Stuks: 100 Schroef HI-LO 3,2 x 13 (te bestellen per 100 stuks)



## Verticaal inbouwkader voor twee functies

Dit dubbele verticale inbouwkader is geschikt voor het inbouwen van twee functies. Het geheel is spuitwaterdicht wat het uitermate geschikt maakt voor gebruik in vochtige ruimtes en veeleisende omgevingen.

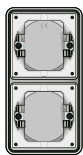

### TWEEVOUDIG INBOUWKADER VERTICAAL



|   |                  |          |                               |
|---|------------------|----------|-------------------------------|
|   | <b>700-74000</b> | Stuks: 3 | Tweevoudig inbouwkader, grey  |
|  | <b>701-74000</b> | Stuks: 3 | Tweevoudig inbouwkader, white |
|  | <b>761-74000</b> | Stuks: 3 | Tweevoudig inbouwkader, black |

### TOEBEHOREN



**170-00093** Stuks: 100 Schroef HI-LO 3,2 x 13 (te bestellen per 100 stuks)



## Horizontaal inbouwkader voor twee functies

Dit dubbele horizontale inbouwkader is geschikt voor het inbouwen van twee functies. Het geheel is spuitwaterdicht wat het uitermate geschikt maakt voor gebruik in vochtige ruimtes en veeleisende omgevingen.

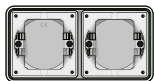

### TWEEVOUDIG INBOUWKADER HORIZONTAAL



|   |                  |          |                               |
|---|------------------|----------|-------------------------------|
|  | <b>700-75000</b> | Stuks: 3 | Tweevoudig inbouwkader, grey  |
|  | <b>701-75000</b> | Stuks: 3 | Tweevoudig inbouwkader, white |
|  | <b>761-75000</b> | Stuks: 3 | Tweevoudig inbouwkader, black |

### TOEBEHOREN



**170-00093** Stuks: 100 Schroef HI-LO 3,2 x 13 (te bestellen per 100 stuks)

D.1

D.2

D.3

D.4

D.5

D.6





De meest recente informatie  
vind je op [www.niko.eu](http://www.niko.eu)



### Blindplaat

#### ACCESSOIRES



|   |                  |           |                   |
|---|------------------|-----------|-------------------|
|  | <b>700-38500</b> | Stuks: 10 | Blindplaat, grey  |
|  | <b>701-38500</b> | Stuks: 10 | Blindplaat, white |
|  | <b>761-38500</b> | Stuks: 10 | Blindplaat, black |



### M20-wartel

#### ACCESSOIRES



**700-84001** Stuks: 50 M20-wartel, grey



**701-84001** Stuks: 50 M20-wartel, white



**761-84001** Stuks: 50 M20-wartel, black



### M20-blindstop

#### ACCESSOIRES



**700-84000** Stuks: 100 M20-blindstop, grey



**701-84000** Stuks: 100 M20-blindstop, white





**761-84000** Stuks: 100 M20-blindstop, black

## Ledverlichtingselement voor controleschakelaars en verlichtbare drukknoppen

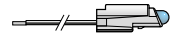
Het ledverlichtingselement met automatische aansluiting heeft een signalisatiefunctie in combinatie met een wissel- of kruisschakelaar, een NO- of NG-drukknop of een 2x NO- of NG-drukknop. In combinatie met een tweepolige schakelaar heeft dit ledverlichtingselement een controlefunctie.



### LEDVERLICHTINGSELEMENTEN SPECIFIEK VOOR SCHAKELAARS MET SCHROEFKLEMMEN

|  |              |                  |           |   |
|--|--------------|------------------|-----------|---|
|  | <b>NIEUW</b> | <b>170-37023</b> | Stuks: 10 | Met automatische aansluiting, wit, 230 Vac          |
|  |              | <b>170-37123</b> | Stuks: 10 | Met automatische aansluiting, blauw, 230 Vac        |
|  |              | <b>170-37323</b> | Stuks: 10 | Met automatische aansluiting, amberkleurig, 230 Vac |

### LEDVERLICHTINGSELEMENTEN

|  |              |                  |           |                                      |
|--|--------------|------------------|-----------|--------------------------------------|
|    | <b>NIEUW</b> | <b>170-37012</b> | Stuks: 10 | Met draden, wit, 12 Vac/Vdc          |
|    | <b>NIEUW</b> | <b>170-37024</b> | Stuks: 10 | Met draden, wit, 24 Vac/Vdc          |
|    | <b>NIEUW</b> | <b>170-37923</b> | Stuks: 10 | Met draden, wit, 230 Vac             |
|    |              | <b>170-37212</b> | Stuks: 10 | Met draden, blauw, 12 Vac/Vdc        |
|   |              | <b>170-37224</b> | Stuks: 10 | Met draden, blauw, 24 Vac/Vdc        |
|  |              | <b>170-37223</b> | Stuks: 10 | Met draden, blauw, 230 Vac           |
|  |              | <b>170-37424</b> | Stuks: 10 | Met draden, amberkleurig, 24 Vac/Vdc |
|  |              | <b>170-37423</b> | Stuks: 10 | Met draden, amberkleurig, 230 Vac    |
|  |              | <b>170-37623</b> | Stuks: 10 | Met draden, rood, 230 Vac            |
|  |              | <b>170-37823</b> | Stuks: 10 | Met draden, groen, 230 Vac           |

D.1

D.2

D.3

D.4

D.5

D.6



De meest recente informatie  
vind je op [www.niko.eu](http://www.niko.eu)



Finder Archief Wijzig Weergave Ga Venster Help

...ale  
...atalog  
...atalog



# Installatiekanalen

## Voor een nette, professionele afwerking

**Bekabeling integreren in een interieur zonder breek- of slijpwerk?**

Met de installatiekanalen van Niko zorg je voor een nette, naadloze afwerking die eenvoudig en vlot te monteren is.

### VOORDELEN

#### **Compact**

- beperkt aantal producten
- volledige oplossing voor elke locatie

#### **Flexibel**

- geschikt voor horizontale en verticale montage
- geschikt voor montage op labotafels

#### **Eenvoudige montage**

- 1 installateur klaart de klus
- de bodem heeft om de 25 cm een boorgeleiding
- grote bedradingscapaciteit
- wandcontactdozen en data-outlets klik je rechtstreeks in het kanaal
- robuust en stevig dankzij het dubbelwandige concept
- een ophoogkader maakt extra kabelcapaciteit mogelijk in mono- en duokanaal
- perfecte scheiding tussen sterk- en zwakstroom

#### **Duurzame kwaliteit**

- materiaal: PVC
- RAL 9010, in de massa gekleurd
- beschermingsgraad: IP40
- slagvast: IK07

D.1

D.2

D.3

D.4

D.5

D.6



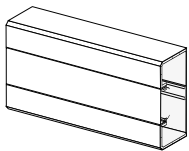

### Enkelvoudig kanaal

Optioneel gebruik van een ophoogkader voor één of twee functies.

- kanaalhoogte: 110 mm
- kanaal diepte: 50 mm
- kanaallengte: 2 m







#### BASISELEMENTEN

|               |           |                               |
|---------------|-----------|-------------------------------|
| <b>06-103</b> | Stuks: 5  | Platte hoek                   |
| <b>06-107</b> | Stuks: 5  | T-stuk                        |
| <b>06-201</b> | Stuks: 10 | Variabele binnenhoek, 80-100° |
| <b>06-202</b> | Stuks: 10 | Variabele buitenhoek, 70-110° |
| <b>06-206</b> | Stuks: 20 | Eindstuk                      |

#### ENKELVOUDIG KANAAL

|               |          |            |
|---------------|----------|------------|
| <b>06-200</b> | Stuks: 6 | Met deksel |
|---------------|----------|------------|

#### ACCESSOIRES

|   |               |           |  |
|---|---------------|-----------|--|
|    | <b>06-104</b> | Stuks: 10 | Naadafdichting                             |
|    | <b>06-105</b> | Stuks: 10 | Verbindingsstuk voor kanaalbodems          |
|    | <b>06-190</b> | Stuks: 20 | Kanaaldeksel (lengte: 2 m)                 |
|    | <b>06-191</b> | Stuks: 10 | Ophoogkader voor één functie, 45 x 45 mm   |
|  | <b>06-192</b> | Stuks: 10 | Ophoogkader voor twee functies, 45 x 45 mm |
|  | <b>06-208</b> | Stuks: 20 | Scheidingswand (lengte: 2 m)               |
|  | <b>06-293</b> | Stuks: 20 | Kabelhouder                                |



**Tweevoudig kanaal**

Optioneel gebruik van een ophoogkader voor één of twee functies.

- kanaalhoogte: 160 mm
- kanaalbreedte: 50 mm
- kanaallengte: 2 m

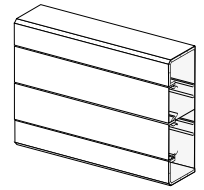





**TWEEVOUDIG KANAAL**

**06-300** Stuks: 4 Met deksel

**BASISELEMENTEN**

**06-301** Stuks: 10 Variabele binnenhoek, 80-100°  
**06-302** Stuks: 10 Variabele buitenhoek, 70-110°  
**06-303** Stuks: 6 Platte hoek  
**06-306** Stuks: 20 Eindstuk

**ACCESSOIRES**

|  |               |           |  |
|--|---------------|-----------|--|
|    | <b>06-104</b> | Stuks: 10 | Naadafdichting                             |
|    | <b>06-105</b> | Stuks: 10 | Verbindingsstuk voor kanaalbodems          |
|    | <b>06-190</b> | Stuks: 20 | Kanaaldeksel (lengte: 2 m)                 |
|    | <b>06-191</b> | Stuks: 10 | Ophoogkader voor één functie, 45 x 45 mm   |
|  | <b>06-192</b> | Stuks: 10 | Ophoogkader voor twee functies, 45 x 45 mm |
|  | <b>06-208</b> | Stuks: 20 | Scheidingswand (lengte: 2 m)               |
|  | <b>06-293</b> | Stuks: 20 | Kabelhouder                                |

**Wandcontactdoos met één klemmenblok met insteekaansluiting, 45 x 45 mm**

Met randaarde en kinderveiligheid.



 16 A  
250 Vac

**SAMENGESTELD APPARAAT**

**06-002-11** Stuks: 5 Tweevoudig  
**06-003-11** Stuks: 3 Drievoudig  
**06-004-11** Stuks: 2 Viervoudig  
**06-005-11** Stuks: 2 Vijfvoudig

**Wandcontactdoos met één klemmenblok met insteekaansluiting en ophoogkader, 45 x 45 mm**

Met randaarde en kinderveiligheid.

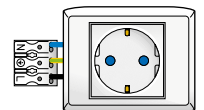

 16 A  
250 Vac

**SAMENGESTELD APPARAAT**

**06-000-21** Stuks: 5 Enkelvoudig  
**06-002-21** Stuks: 5 Tweevoudig



De meest recente informatie  
vind je op [www.niko.eu](http://www.niko.eu)

D.1

D.2

D.3

D.4

D.5

D.6



### Wandcontactdoos met twee wieland GST18-connectoren, 45 x 45 mm

Met randaarde en kinderveiligheid.

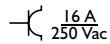

#### SAMENGESTELD APPARAAT

|                  |           |            |
|------------------|-----------|------------|
| <b>06-002-51</b> | Stuks: 10 | Tweevoudig |
| <b>06-003-51</b> | Stuks: 8  | Drievoudig |
| <b>06-004-51</b> | Stuks: 2  | Viervoudig |
| <b>06-005-51</b> | Stuks: 2  | Vijfvoudig |



### Drukknop, 10 A/250 Vac

Het ledverlichtingselement moet afzonderlijk worden besteld.



#### VOLLEDIG APPARAAT

|                  |           |   |
|------------------|-----------|---|
| <b>101-01010</b> | Stuks: 10 | Drukknop, NO of NG (22,5 x 45 mm)   |
| <b>101-07010</b> | Stuks: 10 | Verlichtbare drukknop met transparant venstertje, NO of NG (22,5 x 45 mm) |
| <b>101-09010</b> | Stuks: 10 | Drukknop met verlichtbare etikethouder, NO of NG (22,5 x 45 mm)           |

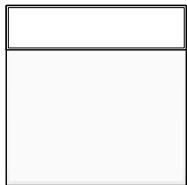

### Schakelaar, 10 A/250 Vac

Het ledverlichtingselement moet afzonderlijk worden besteld.



#### VOLLEDIG APPARAAT

|                  |           |  |
|------------------|-----------|--|
| <b>101-01210</b> | Stuks: 10 | Tweepolige schakelaar (45 x 45 mm)   |
| <b>101-01610</b> | Stuks: 10 | Wisselschakelaar (22,5 x 45 mm)  |
| <b>101-02610</b> | Stuks: 10 | Tweepolige wisselschakelaar (45 x 45 mm)                                   |
| <b>101-07210</b> | Stuks: 10 | Verlichtbare tweepolige schakelaar met transparant venstertje (45 x 45 mm) |
| <b>101-07610</b> | Stuks: 10 | Verlichtbare wisselschakelaar met transparant venstertje (22,5 x 45 mm)    |
| <b>101-09210</b> | Stuks: 10 | Tweepolige schakelaar met verlichtbare etikethouder (45 x 45 mm)           |
| <b>101-09610</b> | Stuks: 10 | Wisselschakelaar met verlichtbare etikethouder (22,5 x 45 mm)              |



**Datamodule voor Niko RJ-connectoren**

enkelvoudige datamodule (vlak) = 1 enkelvoudige afwerkingsset + 1 passtuk

tweevoudige datamodule (vlak) = 1 tweevoudige afwerkingsset + 2 passtukken

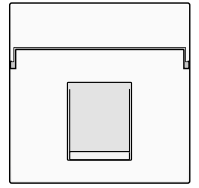
tweevoudige datamodule (schuin) = 1 tweevoudige afwerkingsset + 1 passtuk

**MODULE VOOR ÉÉN NIKO RJ-CONNECTOR, INCLUSIEF PASSTUK**

|  |                  |           |  |
|--|------------------|-----------|--|
|  | <b>101-65250</b> | Stuks: 10 | wit, met transparant tekstveld, 22,5 x 45 mm   |
|  | <b>196-65250</b> | Stuks: 10 | blauw, met transparant tekstveld, 22,5 x 45 mm |
|  | <b>197-65250</b> | Stuks: 10 | groen, met transparant tekstveld, 22,5 x 45 mm |

**PASSTUKKEN VOOR VLAKKE UITVOERING VOOR NIKO CONNECTOREN 650-450XX, ENKELVOUDIG**

|  |                  |           |                         |
|--|------------------|-----------|-------------------------|
|  | <b>170-65901</b> | Stuks: 10 | Enkelvoudig passtuk 9.1 |
|--|------------------|-----------|-------------------------|

**PASSTUKKEN VOOR SCHUINE UITVOERING VOOR NIKO CONNECTOREN 650-450XX, DUBBEL**

|  |                  |           |                               |
|--|------------------|-----------|-------------------------------|
|  | <b>170-65904</b> | Stuks: 10 | Tweevoudig schuin passtuk 9.4 |
|--|------------------|-----------|-------------------------------|













**STANDAARD 45X45 MM-MODULE, VLAK**

|   |                  |           |  |
|---|------------------|-----------|--|
|  | <b>101-65500</b> | Stuks: 10 | Enkelvoudige afwerkingsset met transparant tekstveld |
|---|------------------|-----------|--|

**STANDAARD 45X45 MM-MODULE, VLAK**

|  |                  |           |   |
|--|------------------|-----------|---|
|  | <b>101-65600</b> | Stuks: 10 | Tweevoudige afwerkingsset met transparant tekstveld |
|--|------------------|-----------|---|











**AFWERKINGSSET MET ONDOORZICHTIG TEKSTVELD**

|  |   |                  |           |   |                  |           |   |                  |           |
|--|---|------------------|-----------|---|------------------|-----------|---|------------------|-----------|
|  |  | <b>100-65100</b> | Stuks: 10 |  | <b>101-65100</b> | Stuks: 10 |  | <b>102-65100</b> | Stuks: 10 |
|  |  | <b>104-65100</b> | Stuks: 10 |  | <b>121-65100</b> | Stuks: 10 |  | <b>122-65100</b> | Stuks: 10 |
|  |  | <b>123-65100</b> | Stuks: 10 |  | <b>124-65100</b> | Stuks: 10 |  | <b>154-65100</b> | Stuks: 10 |
|  |  | <b>157-65100</b> | Stuks: 10 |  | <b>161-65100</b> | Stuks: 10 |  | <b>200-65100</b> | Stuks: 10 |
|  |  | <b>220-65100</b> | Stuks: 10 |  | <b>221-65100</b> | Stuks: 10 |   |                  |           |

**AFWERKINGSSET MET ONDOORZICHTIG TEKSTVELD**

|  |   |                  |           |   |                  |           |   |                  |           |
|--|---|------------------|-----------|---|------------------|-----------|---|------------------|-----------|
|  |  | <b>100-65200</b> | Stuks: 10 |  | <b>101-65200</b> | Stuks: 10 |  | <b>111-65200</b> | Stuks: 10 |
|  |  | <b>102-65200</b> | Stuks: 10 |  | <b>104-65200</b> | Stuks: 10 |  | <b>121-65200</b> | Stuks: 10 |
|  |  | <b>122-65200</b> | Stuks: 10 |  | <b>123-65200</b> | Stuks: 10 |  | <b>124-65200</b> | Stuks: 10 |
|  |  | <b>154-65200</b> | Stuks: 10 |  | <b>157-65200</b> | Stuks: 10 |  | <b>161-65200</b> | Stuks: 10 |
|  |  | <b>200-65200</b> | Stuks: 10 |  | <b>220-65200</b> | Stuks: 10 |  | <b>221-65200</b> | Stuks: 10 |

**AFWERKINGSSET MET TRANSPARANT TEKSTVELD, SCHUIN**

|  |   |                  |           |   |                  |           |   |                  |           |
|--|---|------------------|-----------|---|------------------|-----------|---|------------------|-----------|
|  |  | <b>100-65400</b> | Stuks: 10 |  | <b>101-65400</b> | Stuks: 10 |  | <b>102-65400</b> | Stuks: 10 |
|  |  | <b>104-65400</b> | Stuks: 10 |  | <b>121-65400</b> | Stuks: 10 |  | <b>122-65400</b> | Stuks: 10 |
|  |  | <b>123-65400</b> | Stuks: 10 |  | <b>124-65400</b> | Stuks: 10 |  | <b>154-65400</b> | Stuks: 10 |
|  |  | <b>157-65400</b> | Stuks: 10 |  | <b>161-65400</b> | Stuks: 10 |  | <b>200-65400</b> | Stuks: 10 |
|  |  | <b>220-65400</b> | Stuks: 10 |  | <b>221-65400</b> | Stuks: 10 |   |                  |           |

D.1

D.2

D.3

D.4

D.5

D.6

De meest recente informatie vind je op [www.niko.eu](http://www.niko.eu)



### Niko RJ-connector

#### CONNECTOREN

|  |                        |           |                              |
|--|------------------------|-----------|------------------------------|
|  | <b>650-45051</b>       | Stuks: 10 | RJ45-connector, UTP, cat. 5E |
|  | <b>650-45055</b>       | Stuks: 10 | RJ45-connector, STP, cat. 5E |
|  | <b>650-45061</b>       | Stuks: 10 | RJ45-connector, UTP, cat. 6  |
|  | <b>650-45066</b>       | Stuks: 10 | RJ45-connector, STP, cat. 6  |
|  | <b>650-45013</b>       | Stuks: 10 | RJ11-connector, UTP          |
|  | <b>NIEUW 650-45071</b> | Stuks: 10 | RJ45-connector, UTP, cat.6 A |
|  | <b>NIEUW 650-45077</b> | Stuks: 10 | RJ45-connector, STP, cat.6 A |

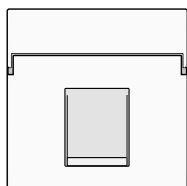

### Enkelvoudige datamodule voor andere RJ-connectoren

datamodule = 1 afwerkingsset + 1 passtuk

Raadpleeg ook de tabel "Datacomaansluitingen voor andere RJ-connectoren" in het hoofdstuk "Medianetwerk".

#### PASSTUKKEN VOOR VLAKKE UITVOERING VOOR ANDERE MERKEN, ENKELVOUDIG

|  |                  |           |   |
|--|------------------|-----------|---|
|  | <b>170-65101</b> | Stuks: 10 | Enkelvoudig passtuk 1 (voor AMP, Siemon, Nexans, Brandrex,...)                        |
|  | <b>170-65201</b> | Stuks: 10 | Enkelvoudig passtuk 2 (voor systimax,...)   |
|  | <b>170-65501</b> | Stuks: 10 | Enkelvoudig passtuk 5 (voor Krone, Kerpen, Radiall, Gigamedia,...)                    |
|  | <b>170-65601</b> | Stuks: 10 | Enkelvoudig passtuk 6 (voor Panduit,...)  |
|  | <b>170-65701</b> | Stuks: 10 | Enkelvoudig passtuk 7 (voor CAE, Multimedia Connect/MMC, Abitana, Prysman, Molex,...) |

#### PASSTUKKEN VOOR VLAKKE UITVOERING VOOR OUDE NIKO CONNECTOREN 02-399-XX, ENKELVOUDIG

|  |                  |           |                         |
|--|------------------|-----------|-------------------------|
|  | <b>170-65401</b> | Stuks: 10 | Enkelvoudig passtuk 4.1 |
|--|------------------|-----------|-------------------------|

#### AFWERKINGSSET MET ONDOORZICHTIG TEKSTVELD

|  |                  |           |                  |           |                  |           |
|--|------------------|-----------|------------------|-----------|------------------|-----------|
|  | <b>100-65100</b> | Stuks: 10 | <b>101-65100</b> | Stuks: 10 | <b>102-65100</b> | Stuks: 10 |
|  | <b>104-65100</b> | Stuks: 10 | <b>121-65100</b> | Stuks: 10 | <b>122-65100</b> | Stuks: 10 |
|  | <b>123-65100</b> | Stuks: 10 | <b>124-65100</b> | Stuks: 10 | <b>154-65100</b> | Stuks: 10 |
|  | <b>157-65100</b> | Stuks: 10 | <b>161-65100</b> | Stuks: 10 | <b>200-65100</b> | Stuks: 10 |
|  | <b>220-65100</b> | Stuks: 10 | <b>221-65100</b> | Stuks: 10 |                  |           |

#### STANDAARD 45X45 MM-MODULE, VLAK

|  |                  |           |  |
|--|------------------|-----------|--|
|  | <b>101-65500</b> | Stuks: 10 | Enkelvoudige afwerkingsset met transparant tekstveld |
|--|------------------|-----------|--|

**Tweevoudige datamodule voor andere RJ-connectoren**

datamodule = 1 afwerkingsset + 2 enkelvoudige passtukken of 1 tweevoudig passtuk

Raadpleeg ook de tabel "Datacomaansluitingen voor andere RJ-connectoren" in het hoofdstuk "Medianetwerk".

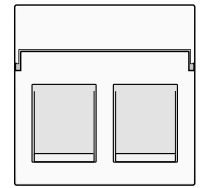
**PASSTUKKEN VOOR VLAKE UITVOERING VOOR ANDERE MERKEN, ENKELVOUDIG**

|  |                  |           |   |
|--|------------------|-----------|---|
|  | <b>170-65101</b> | Stuks: 10 | Enkelvoudig passtuk 1 (voor AMP, Siemon, Nexans, Brandrex,...)                        |
|  | <b>170-65201</b> | Stuks: 10 | Enkelvoudig passtuk 2 (voor systemax,...)   |
|  | <b>170-65501</b> | Stuks: 10 | Enkelvoudig passtuk 5 (voor Krone, Kerpen, Radiall, Gigamedia,...)                    |
|  | <b>170-65601</b> | Stuks: 10 | Enkelvoudig passtuk 6 (voor Panduit,...)  |
|  | <b>170-65701</b> | Stuks: 10 | Enkelvoudig passtuk 7 (voor CAE, Multimedia Connect/MMC, Abitana, Pysmian, Molex,...) |

**PASSTUKKEN VOOR VLAKE UITVOERING VOOR ANDERE MERKEN, DUBBEL**

|  |                  |           |                        |
|--|------------------|-----------|------------------------|
|  | <b>170-65302</b> | Stuks: 10 | Tweevoudig passtuk 3.2 |
|--|------------------|-----------|------------------------|

**AFWERKINGSSET MET ONDOORZICHTIG TEKSTVELD**

|  |  |                  |           |  |                  |           |  |                  |           |
|--|--|------------------|-----------|--|------------------|-----------|--|------------------|-----------|
|  |  | <b>100-65200</b> | Stuks: 10 |  | <b>101-65200</b> | Stuks: 10 |  | <b>111-65200</b> | Stuks: 10 |
|  |  | <b>102-65200</b> | Stuks: 10 |  | <b>104-65200</b> | Stuks: 10 |  | <b>121-65200</b> | Stuks: 10 |
|  |  | <b>122-65200</b> | Stuks: 10 |  | <b>123-65200</b> | Stuks: 10 |  | <b>124-65200</b> | Stuks: 10 |
|  |  | <b>154-65200</b> | Stuks: 10 |  | <b>157-65200</b> | Stuks: 10 |  | <b>161-65200</b> | Stuks: 10 |
|  |  | <b>200-65200</b> | Stuks: 10 |  | <b>220-65200</b> | Stuks: 10 |  | <b>221-65200</b> | Stuks: 10 |

**STANDAARD 45X45 MM-MODULE, VLAKE**

|  |                  |           |   |
|--|------------------|-----------|---|
|  | <b>101-65600</b> | Stuks: 10 | Tweevoudige afwerkingsset met transparant tekstveld |
|--|------------------|-----------|---|

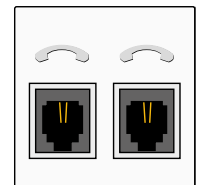
**Telefooncontactdoos, 45 x 45 mm****VOLLEDIG APPARAAT**

|  |                  |           |   |
|--|------------------|-----------|---|
|  | <b>101-69032</b> | Stuks: 10 | Telefooncontactdoos met twee RJ11-connectoren in parallel |
|  | <b>101-69092</b> | Stuks: 10 | ADSL-VDSL-splitter met twee RJ11-connectoren              |

D.1

D.2

D.3

D.4

D.5

D.6





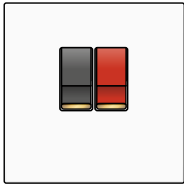











De meest recente informatie  
vind je op [www.niko.eu](http://www.niko.eu)



**Audioaansluiting, 45 x 45 mm**















**AFWERKINGSSET VOOR TWEEVOUDIGE CINCH-AANSLUITING**



|   |                  |           |   |                  |           |   |                  |           |
|---|------------------|-----------|---|------------------|-----------|---|------------------|-----------|
|  | <b>100-69716</b> | Stuks: 10 |  | <b>101-69716</b> | Stuks: 10 |  | <b>102-69716</b> | Stuks: 10 |
|  | <b>104-69716</b> | Stuks: 10 |  | <b>121-69716</b> | Stuks: 10 |  | <b>122-69716</b> | Stuks: 10 |
|  | <b>123-69716</b> | Stuks: 10 |  | <b>124-69716</b> | Stuks: 10 |  | <b>154-69716</b> | Stuks: 10 |
|  | <b>157-69716</b> | Stuks: 10 |  | <b>161-69716</b> | Stuks: 10 |  | <b>200-69716</b> | Stuks: 10 |
|  | <b>220-69716</b> | Stuks: 10 |  | <b>221-69716</b> | Stuks: 10 |   |                  |           |

**AFWERKINGSSET VOOR DRIEVOUDIGE CINCH-AANSLUITING**



|   |                  |           |   |                  |           |   |                  |           |
|---|------------------|-----------|---|------------------|-----------|---|------------------|-----------|
|  | <b>100-69717</b> | Stuks: 10 |  | <b>101-69717</b> | Stuks: 10 |  | <b>102-69717</b> | Stuks: 10 |
|  | <b>104-69717</b> | Stuks: 10 |  | <b>121-69717</b> | Stuks: 10 |  | <b>122-69717</b> | Stuks: 10 |
|  | <b>123-69717</b> | Stuks: 10 |  | <b>124-69717</b> | Stuks: 10 |  | <b>154-69717</b> | Stuks: 10 |
|  | <b>157-69717</b> | Stuks: 10 |  | <b>161-69717</b> | Stuks: 10 |  | <b>200-69717</b> | Stuks: 10 |
|  | <b>220-69717</b> | Stuks: 10 |  | <b>221-69717</b> | Stuks: 10 |   |                  |           |

**VOLLEDIG APPARAAT**



**101-69703** Stuks: 10 Tweevoudige luidsprekeraansluiting



**101-69803** Stuks: 10 Enkelvoudige luidsprekeraansluiting

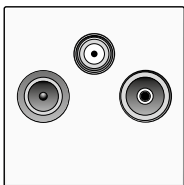

**Tv-fm-contactdoos, 45 x 45 mm**

**VOLLEDIG APPARAAT**



**101-69121** Stuks: 10 Enkelvoudige contactdoos met coxaansluiting voor tv



**101-69501** Stuks: 10 Enkelvoudige contactdoos met coxaansluiting voor tv en FM



**101-69552** Stuks: 10 Enkelvoudige contactdoos met coxaansluiting voor tv, FM en satelliet



**101-69601** Stuks: 10 Doorluscontactdoos met coxaansluiting voor tv en FM

## Ledverlichtingselement

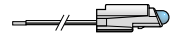

## LEDVERLICHTINGSELEMENTEN

|  |              |                  |           |                                      |
|--|--------------|------------------|-----------|--------------------------------------|
|    | <b>NIEUW</b> | <b>170-37012</b> | Stuks: 10 | Met draden, wit, 12 Vac/Vdc          |
|    | <b>NIEUW</b> | <b>170-37024</b> | Stuks: 10 | Met draden, wit, 24 Vac/Vdc          |
|    | <b>NIEUW</b> | <b>170-37923</b> | Stuks: 10 | Met draden, wit, 230 Vac             |
|    |              | <b>170-37212</b> | Stuks: 10 | Met draden, blauw, 12 Vac/Vdc        |
|    |              | <b>170-37224</b> | Stuks: 10 | Met draden, blauw, 24 Vac/Vdc        |
|    |              | <b>170-37223</b> | Stuks: 10 | Met draden, blauw, 230 Vac           |
|    |              | <b>170-37424</b> | Stuks: 10 | Met draden, amberkleurig, 24 Vac/Vdc |
|    |              | <b>170-37423</b> | Stuks: 10 | Met draden, amberkleurig, 230 Vac    |
|    |              | <b>170-37623</b> | Stuks: 10 | Met draden, rood, 230 Vac            |
|  |              | <b>170-37823</b> | Stuks: 10 | Met draden, groen, 230 Vac           |

D.1

D.2

D.3

D.4

D.5

D.6



De meest recente informatie  
vind je op [www.niko.eu](http://www.niko.eu)

## Niko-productkwaliteit

### CE-markering

Door een product CE te markeren, verklaart de fabrikant op eigen verantwoordelijkheid dat het product beantwoordt aan de toepasselijke Europese richtlijnen en verordeningen die CE-markering vereisen. Je vind de CE-markering op elektrische en elektronische producten van Niko. Binnen de Europese Unie (EU) en de Europese Vrijhandelsassociatie (EVA) is vrij verkeer van goederen mogelijk dankzij deze markering. De FOD Economie houdt hierop toezicht. Het toepassingsgebied van de CE-markering en de gebruikte normen staan in de EU-verklaring van overeenstemming die je kunt raadplegen op [www.niko.eu](http://www.niko.eu).

### Kwaliteitskeurmerken



= nationaal keurmerk België



= nationaal keurmerk Nederland



= nationaal keurmerk Duitsland



= nationaal keurmerk Frankrijk



= nationaal keurmerk Oostenrijk

Deze waarborgen de conformiteit aan de geldende nationale normen van alle producten. De conformiteit wordt gewaarborgd door het keuringsorganisme. De producten worden in gehomologeerde labo's getest alvorens ze op de markt komen. Periodieke fabriekscontroles waarborgen de conformiteit van de producten. De geldende normen zijn er om de veiligheid, de bedrijfszekerheid en de prestaties van de producten te waarborgen. Voor vragen omtrent de keurmerken van een specifiek product kun je steeds bij Niko terecht.

### Niko productkwaliteit

Bij Niko zijn de kwaliteitsmetingen geen periodiek, maar een permanent gegeven. Kwaliteitscontrole is de rode draad doorheen het hele ontwerp- en productieproces. Zowel ontwerp, prototypes, grondstoffen, halffabrikaten en afgewerkte producten worden continu gecontroleerd. Dit kwaliteitssysteem verzekert een constante, uitmuntende kwaliteit.

### Fabriekscontrole:



heeft geen gedefinieerde eisen.



doet periodieke controles door onafhankelijke organismes.

**niko** doet continu eindcontrole.

### Betrouwbaarheid:



stelt geen enkele eis.



gaat na dat de prestaties van het product strikt aan de normen voldoen.

**niko** maakt lastenboeken die de eisen van de norm overstijgen.

### Veiligheid:



goedkeuring door de fabrikant.



gaat na dat van bij het productconcept strikt aan de normen voldaan wordt.

**niko** stelt bijkomende eisen in functie van de toepassing.

### Installatiegemak:



geen enkele eis.



geen enkele eis.

**niko** zorgt voor een absoluut gebruikersgemak.

### Waarborg voor installateur en gebruiker:



is het paspoort voor het vrije verkeer binnen de Europese Unie.



verzekert een eerste onmisbaar kwaliteitsniveau.

**niko** waarborgt de kwaliteitseisen van een groot merk dat zich engageert.

De aansluitschema's, zoals afgedrukt op de bijsluiters van het toestel, hebben steeds voorrang op de typeschema's afgedrukt in deze catalogus. Technische gegevens kunnen, als algemene regel, wijzigen zonder voorafgaande mededeling.



## Beschermingsgraden

### Weergeven van schokweerstand

De schokweerstand wordt weergegeven aan de hand van een IK-waarde en de beschermingsgraad aan de hand van de IP-code, zoals beschreven in de normen EN 62262 en IEC60529.

### IP-code volgens IEC 60529: IP X1X2 - X3

| X1 =   | Bescherming tegen aanraking van onder spanning staande delen en tegen indringen van vaste voorwerpen |   |
|--------|--|---|
| X1 = 0 |  | geen bescherming  |
| X1 = 1 |  | beschermd tegen voorwerp $\geq \varnothing 50$ mm (b.v. vuist)        |
| X1 = 2 |  | beschermd tegen voorwerp $\geq \varnothing 12,5$ mm (b.v. vinger)     |
| X1 = 3 |  | beschermd tegen voorwerp $\geq \varnothing 2,5$ mm (b.v. gereedschap) |
| X1 = 4 |  | beschermd tegen voorwerp $\geq \varnothing 1$ mm (b.v. pen)           |
| X1 = 5 |  | beschermd tegen stof (veroorzaakt geen schade aan de werking)         |
| X1 = 6 |  | volledig stofdicht  |

| X2 =   | Bescherming tegen indringen van vloeistoffen |   |
|--------|--|---|
| X2 = 0 |  | geen bescherming  |
| X2 = 1 |  | beschermd tegen verticaal vallende druppels (b.v. condens)                      |
| X2 = 2 |  | beschermd tegen waterspatten tot 15° van verticale as (b.v. lichte regen)       |
| X2 = 3 |  | beschermd tegen vallende druppels tot 60° van verticale as (b.v. besproeien)    |
| X2 = 4 |  | beschermd tegen waterspatten in alle richtingen (b.v. besproeien)               |
| X2 = 5 |  | beschermd tegen waterstraal in alle richtingen (b.v. bespuiten)                 |
| X2 = 6 |  | beschermd tegen krachtige waterstraal (extreme weersomstandigheden, b.v. schip) |
| X2 = 7 |  | beschermd tegen tijdelijke onderdompeling                                       |
| X2 = 8 |  | beschermd tegen langdurige onderdompeling (druk)                                |

### Bijkomende letter na IP x1 x2 - ...

(voor gebruik met X1)

|   |       |  |   |
|---|-------|--|---|
| A | 0     |  | Bescherming tegen aanraking met de rug van de hand.                   |
| B | 0,1   |  | Bescherming tegen aanraking met een vinger.                           |
| C | 1,2   |  | Bescherming tegen aanraking met een gereedschap $\varnothing 2,5$ mm. |
| D | 1,2,3 |  | Bescherming tegen aanraking met een draad $\varnothing 1$ mm.         |

### IK-waarden volgens NBN EN 62262: slagvastheid

|    | Hamer (massa in kg) | Valhoogte (mm) | Slagenergie (J) |
|----|---------------------|----------------|-----------------|
| 00 | •                   | •              | •               |
| 01 | M = 0,2 kg          | h = 75 mm      | 0,15            |
| 02 | M = 0,2 kg          | h = 100 mm     | 0,2             |
| 03 | M = 0,2 kg          | h = 150 mm     | 0,35            |
| 04 | M = 0,2 kg          | h = 250 mm     | 0,5             |
| 05 | M = 0,2 kg          | h = 350 mm     | 0,7             |
| 06 | M = 0,5 kg          | h = 200 mm     | 1               |
| 07 | M = 0,5 kg          | h = 400 mm     | 2               |
| 08 | M = 1,7 kg          | h = 295 mm     | 5               |
| 09 | M = 5 kg            | h = 200 mm     | 10              |
| 10 | M = 5 kg            | h = 400 mm     | 20              |

• = geen bescherming

## Chemische weerstand van polycarbonaat en PC/ASA

Weerstand bij onderdompeling op kamertemperatuur: **V** = voldoende; **B** = beperkt; **O** = onvoldoende

|                                |                                |                                 |   |
|--------------------------------|--------------------------------|---------------------------------|---|
| 1. Koolwaterstoffen            | 3. Keton                       | 5. Basen                        | 10. Andere  |
| superbenzine.....O             | aceton.....O                   | natronloog geconcentreerd.....O | wasmiddel.....B   |
| diesel/mazout.....B            | 4. Zuren                       | kaliloog geconcentreerd.....O   | vaatwasmiddelen.....O   |
| wasbenzine.....B               | zoutzuur 20%.....V             | ammoniak verdund.....O          | javel, bleekwater, oplossing van natriumhypochloriet in water.....B |
| 2. Alcoholen                   | zoutzuur tot 35%.....B         | 6. Oliën en vetten.....V        | trichloorethyleen.....O   |
| ethylalcohol 96%.....B         | salpeterzuur 10%.....V         | 7. Siliconolie.....V            | waterstofperoxide 30%.....V   |
| isopropanol.....B              | fosforzuur 30%.....V           | 8. Minerale oliën.....V         | water-heet.....B  |
| fenol.....O                    | zwavelzuur 30%.....V           | 9. Zoutoplossingen              | waterige zeepoplossing.....V  |
| glycol.....B                   | citroenzuur 10%.....V          | natrium hypochloriet.....V      |   |
| glycerine.....B                | azijnzuur 10%.....V            | koud zeewater.....V             |   |
| methanol (methylalcohol).....O | azijnzuur geconcentreerd.....O |                                 |   |

**D.1 Inbouwmaterialiaal**

**Aansluitschema's /**

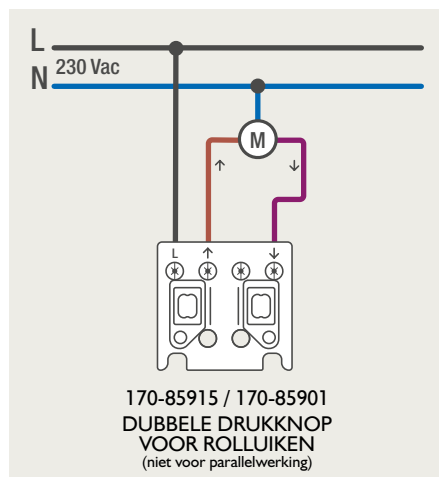
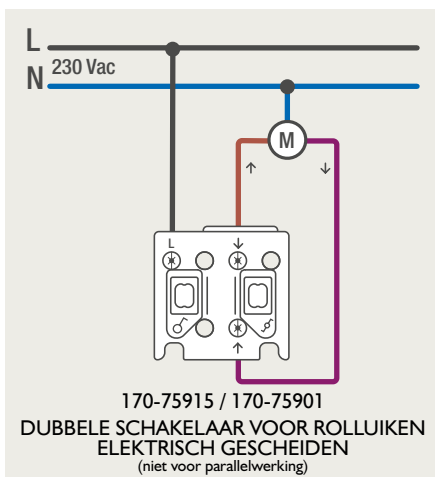
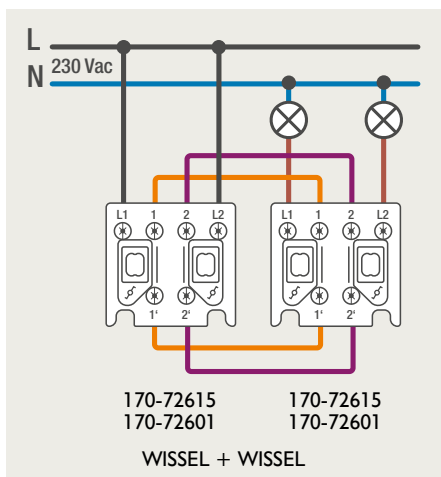
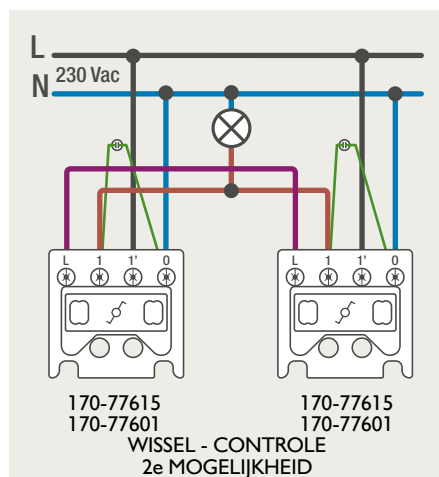
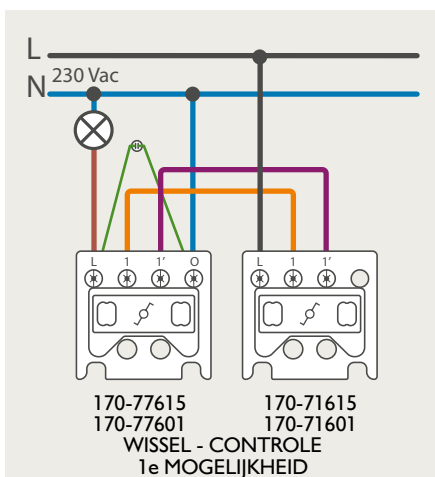
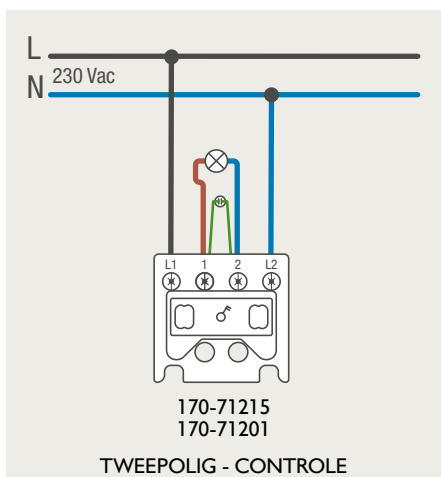
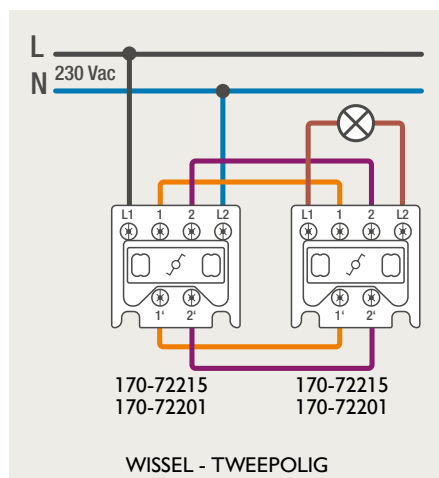
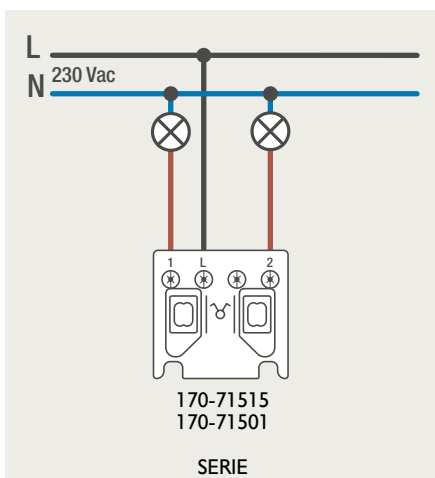
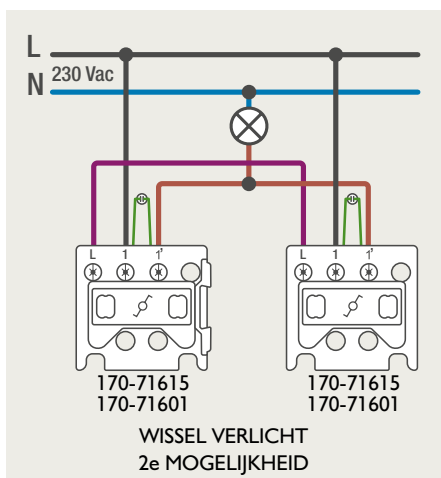
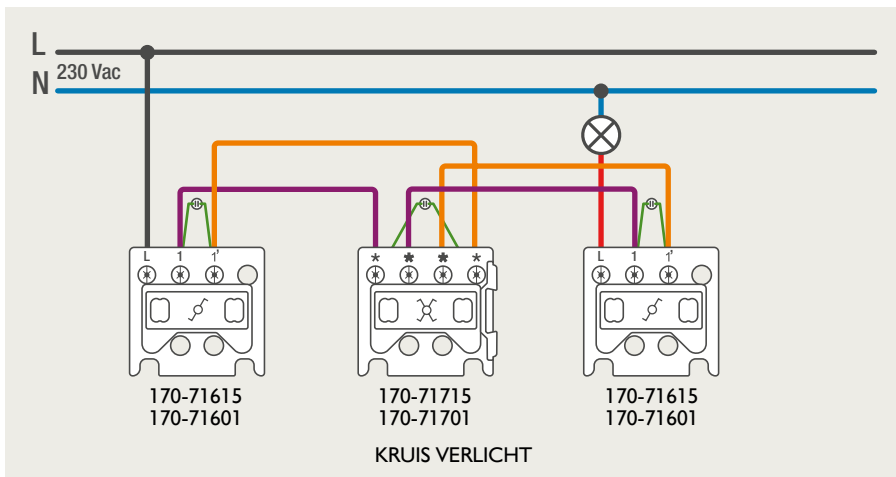
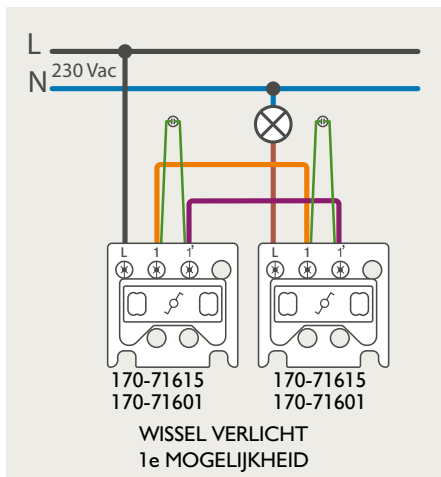

**Inbouwmaterial aansluitschema's**

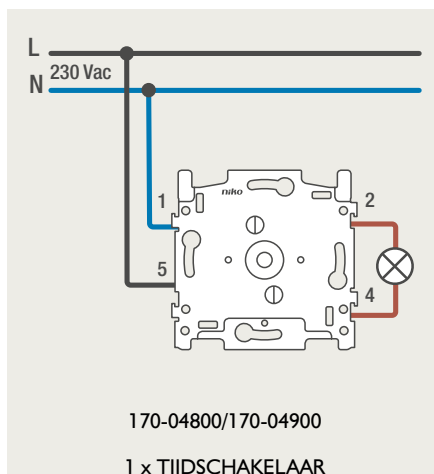
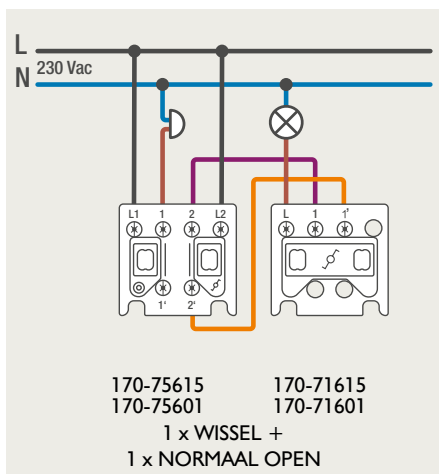
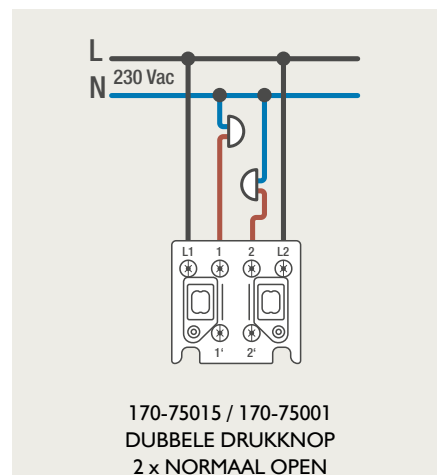
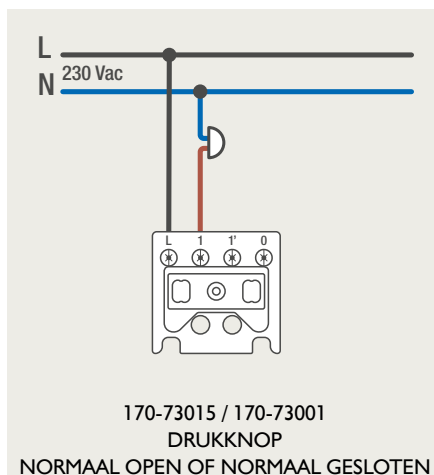
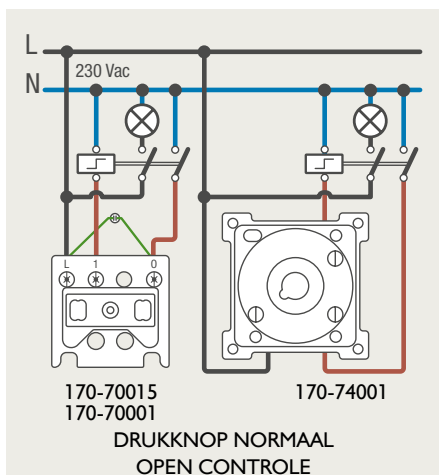
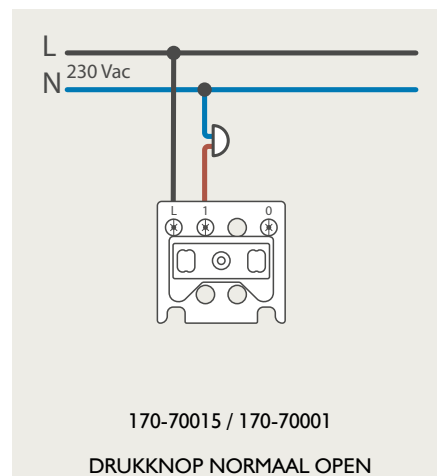
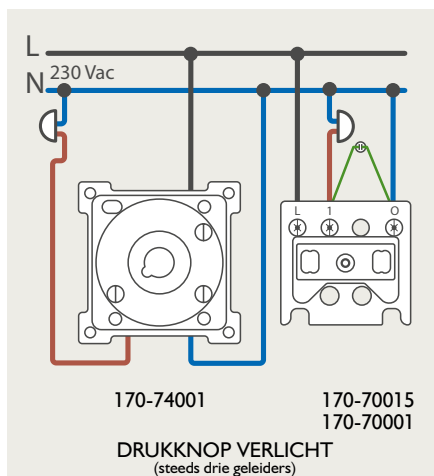
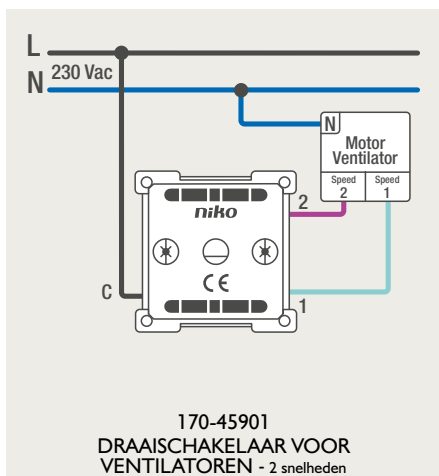
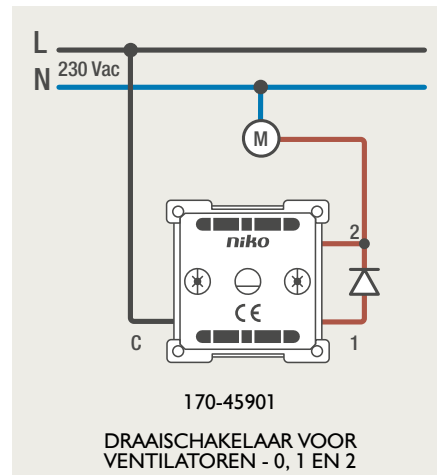
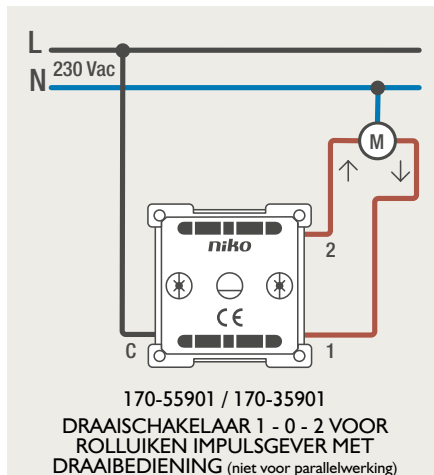

- D.1
- D.2
- D.3
- D.4
- D.5
- D.6



De meest recente informatie vind je op [www.niko.eu](http://www.niko.eu)

**Inbouw materiaal montage trekmodule**

Schakelaarfunctie 1XX-63606

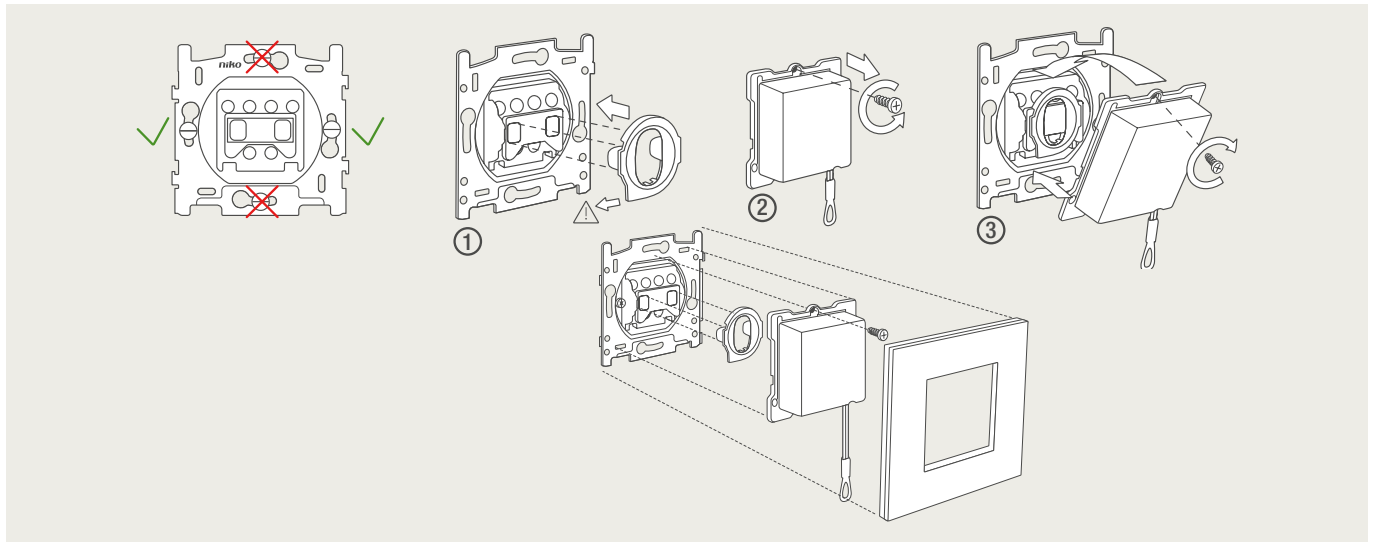

**Drukknopfunctie 1XX-63906**

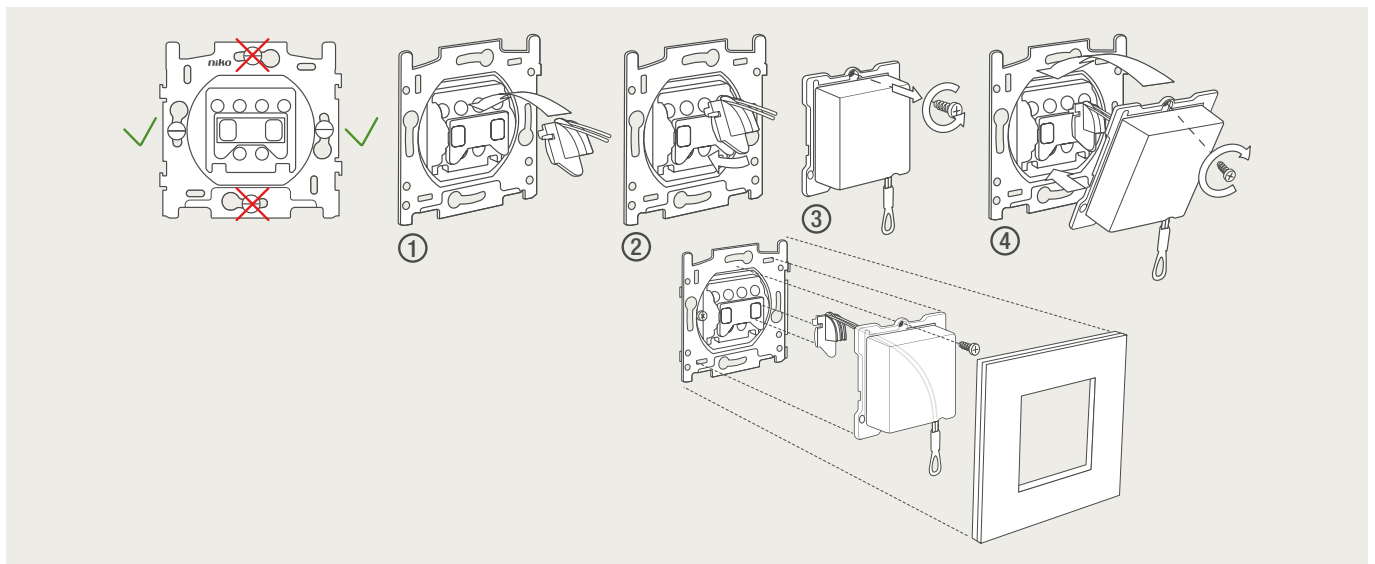

**Demontage trekmodule**

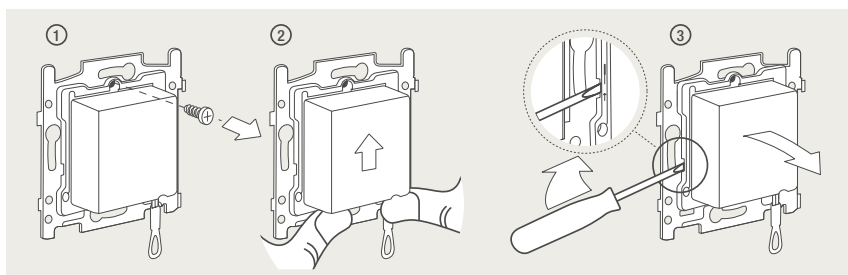

## Module (24 V) met 4 of 6 potentiaalvrije drukknoppen

- De module (24 V) met 4 of 6 potentiaalvrije drukknoppen dient om afstandsschakelaars (telerruptoren) en domoticasystemen aan te sturen. Bij het aansturen van een Niko Home Control installatie kan de interface voor drukknoppen (550-20000) gebruikt worden! Andere aansluitschema's aangaande Niko Home Control vindt u in het technische gedeelte van de catalogus en op de website.
- Aansluitschema's: zie bijlage

### Technische specificaties:

Als u werkt met een afstandsschakelaar, sluit dan de drukknopmodule aan op 24 V~ via een kortsluitvaste veiligheidstransformator.

Als de feedback-LED's van uw domoticasysteem niet op 24 V werken, moet u zelf voor een aanpassing naar 24V DC zorgen.

| gebruik van 24 V voor module        |   | max. schakelvermogen drukknop | voeding LED (24V, ±10%) drukknop | signalisatiekabel  | voor leds                         |
|-------------------------------------|---|-------------------------------|----------------------------------|--|-----------------------------------|
| afstandsschakelaar (wisselspanning) | 24 V~ via kortsluitvaste veiligheidstransformator | max. 25 VA                    | 4 leds = 9 mA<br>6 leds = 13 mA  | 8/10/12/14/16/20<br>min. 0,5mm - max. 0,8mm<br>(bv. SPV/SVV) | klem C2 = +<br>klemmen 123456 = - |
| andere systemen (gelijkspanning)    | 0 - 24 Vdc  | 1 A                           | 4 leds = 5 mA<br>6 leds = 7,5 mA |  |                                   |

- **Aansturen van dimmers: sluit enkel dimmers aan die galvanisch gescheiden zijn: 05-715 / 65-410 / 330-00700.**

Elke module bestaat in 4 verschillende versies: 2 verschillende types bruggen, allebei beschikbaar 'met' en 'zonder' klauwen. De beschikbaarheid van deze versies hangt af van de installatiemethode die gangbaar is in je land.

### 4-voudige potentiaalvrije drukknop zonder led

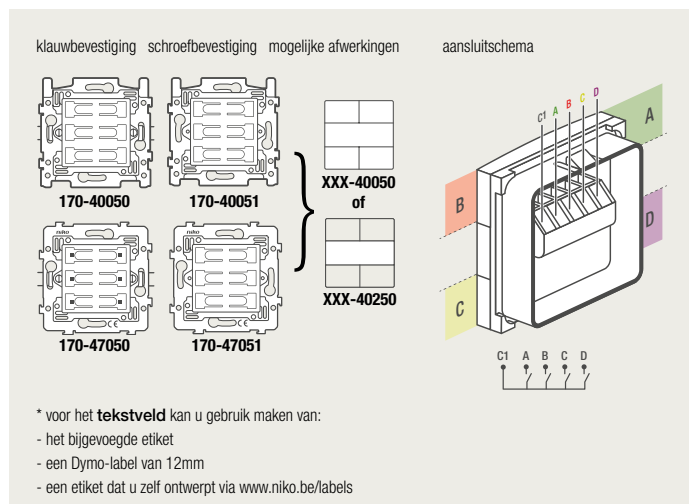

### 4-voudige potentiaalvrije drukknop met led

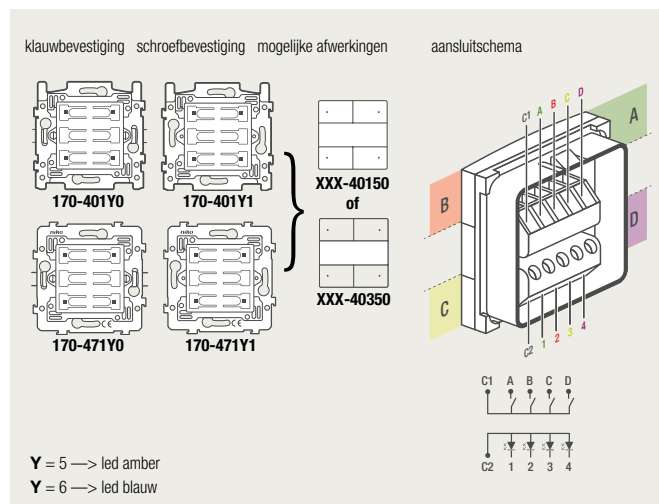

### 6-voudige potentiaalvrije drukknop zonder led

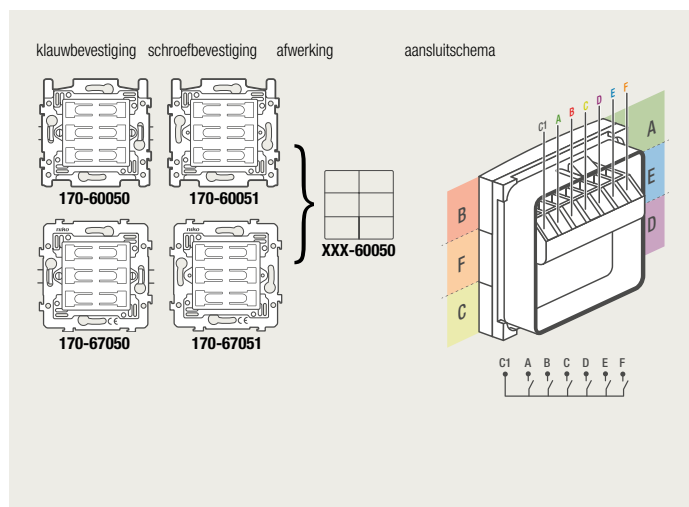

### 6-voudige potentiaalvrije drukknop met led

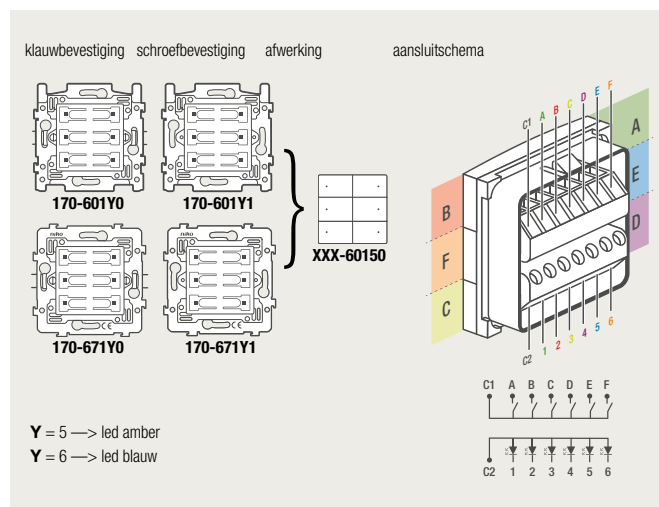

**1 lichtkring vanop 2 plaatsen bedienen**

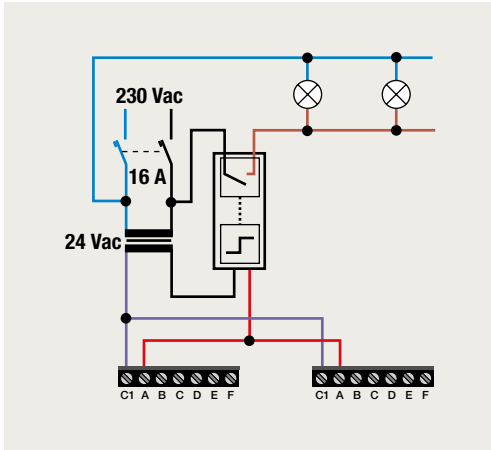

**4 lichtkringen vanop 1 plaats bedienen**

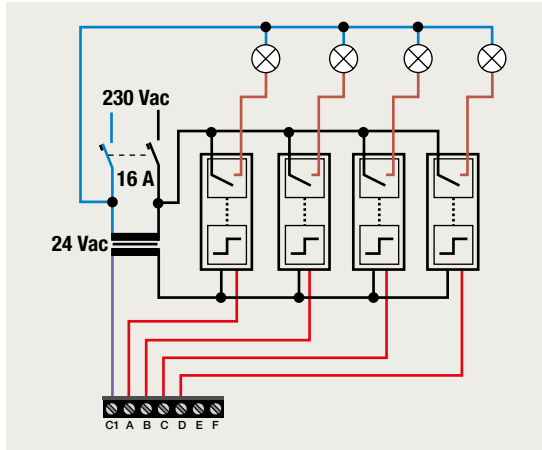

**2 lichtkringen vanop 1 plaats bedienen: 1 = zonder, 2 = met feedback**

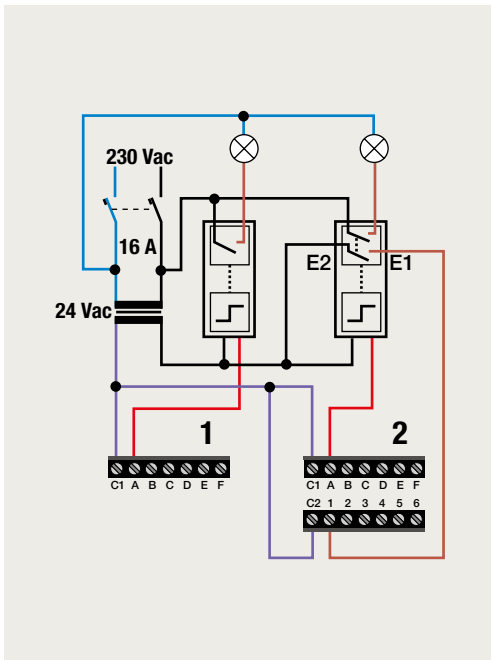

**4 lichtkringen, waarvan 1 gedimd kan worden, van op 1 plaats bedienen**

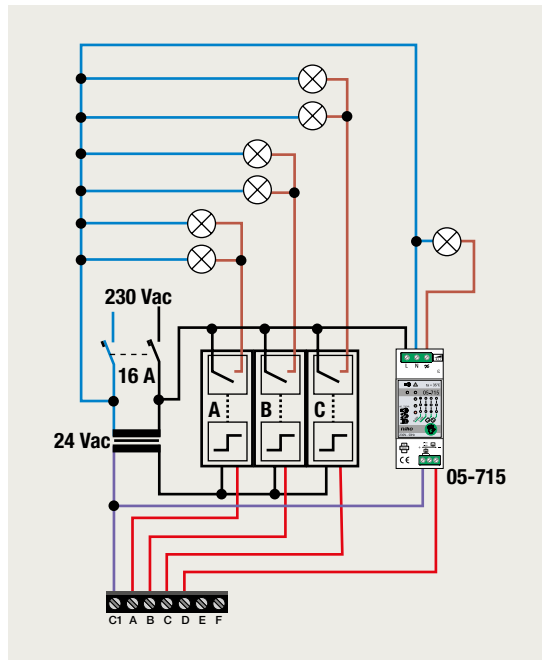

**Niko Home Control via de interface voor drukknoppen (550-20000)**

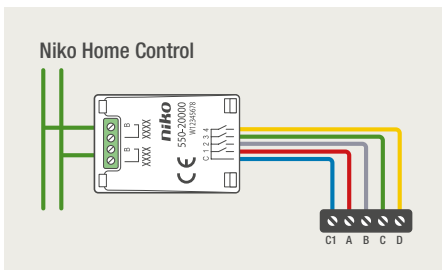

**Bewegingsmelder XXX-7801X: 180° met schakelcontact 10 A, 230 V, 8 m**

A. Eén lichtkring met één detectiepunt  
Sluit de inbouwbewegingsmelder en de belasting aan volgens onderstaand aansluitschema:

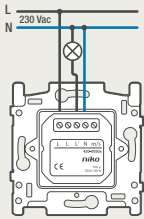

B. Eén lichtkring met meerdere detectiepunten  
In dit geval is er sprake van een master en een slave.  
Je kunt maximaal acht slaves aansluiten op één master.  
Sluit de slave(s) aan op de master volgens onderstaand aansluitschema:

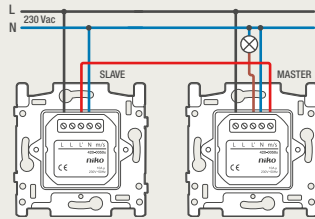

C. Gebruik van een externe drukknop of schakelaar  
Je sluit een externe drukknop of schakelaar aan op de inbouwbewegingsmelder als je het toestel ook manueel moet kunnen bedienen. Je kunt de drukknop of schakelaar zowel op de master als op een slave aansluiten. Volg onderstaand aansluitschema om de drukknop of schakelaar aan te sluiten:

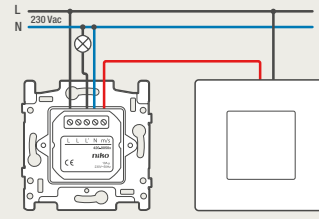
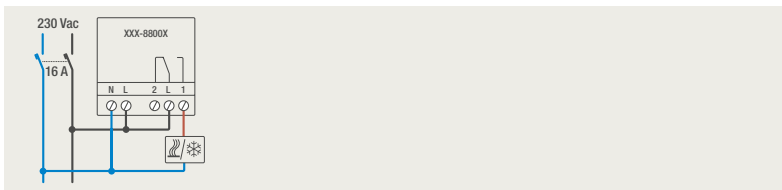
**Elektronische analoge thermostaat XXX-8800X****Blinde afsluitplaat met trekcontlasting 170-00900**

De trekcontlasting voldoet aan de EN60669-1 annex B-norm voor volgende kabels (deze lijst is niet limitatief):

|               |                          |
|---------------|--------------------------|
| H03VVH2-F     | 2 x 0,75 mm <sup>2</sup> |
| H05VV-F       | 3 x 0,75 mm <sup>2</sup> |
| H03VV-F       | 2 x 0,75 mm <sup>2</sup> |
| Telefoonkabel |                          |

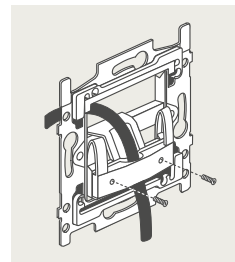
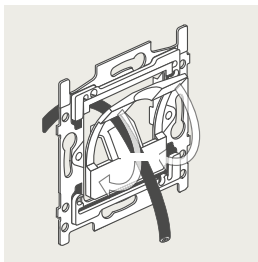

D.1

D.2

D.3

D.4

D.5

D.6



De meest recente informatie vind je op [www.niko.eu](http://www.niko.eu)

## D.2 Medianetwerk

## Hoe kiest u de juiste Niko datacomoplossing?

Eerst zoek je in de tabellen de juiste outlet op aan de hand van het merk en de soort. Daarnaast vind je de overeenstemmende Niko artikelnummers.

| Merk connector | Referentie van fabrikant | Gewenste uitvoering wand-contactdoos | Ref. Passtuk of 45 x 45 mm module | # Passtukken | Inbouwraam Niko;<br>X=6 klauw-bevestiging,<br>X=7 schroef-bevestiging | cpl 1-voudig   |                    | cpl 2-voudig |           |
|----------------|--------------------------|--------------------------------------|-----------------------------------|--------------|---|----------------|--------------------|--------------|-----------|
|                |                          |                                      |                                   |              |   | ΔΔΔ Kleur      | ΔΔΔ Kleur          | ΔΔΔ Kleur    | ΔΔΔ Kleur |
|                |                          |                                      |                                   |              |   | 100 cream      | 121 sterling       |              |           |
|                |                          |                                      |                                   |              |   | 101 white      | 122 anthracite     |              |           |
|                |                          |                                      |                                   |              |   | 102 light grey | 123 bronze         |              |           |
|                |                          |                                      |                                   |              |   | 104 greige     | 124 dark brown     |              |           |
|                |                          |                                      |                                   |              |   |                | 154 white          |              |           |
|                |                          |                                      |                                   |              |   |                | 157 champagne      |              |           |
|                |                          |                                      |                                   |              |   |                | 161 black          |              |           |
|                |                          |                                      |                                   |              |   |                | 200 piano black    |              |           |
|                |                          |                                      |                                   |              |   |                | 201 chocolate      |              |           |
|                |                          |                                      |                                   |              |   |                | 220 alu steel grey |              |           |
|                |                          |                                      |                                   |              |   |                | 221 alu gold       |              |           |
| <b>Niko</b>    |                          |                                      |                                   |              |   |                |                    |              |           |
| Niko           | 650-45013                | vlak enkelvoudig                     | 170-65901                         | 1            | 170-68X00   | ΔΔΔ-65100      |                    |              |           |
|                |                          | vlak tweevoudig                      | 170-65901                         | 2            | 170-68X00   |                |                    | ΔΔΔ-65200    |           |
|                |                          | schuin tweevoudig                    | 170-65904                         | 1            | 170-68X00   |                |                    | ΔΔΔ-65400    |           |
| Niko           | 650-45051                | vlak enkelvoudig                     | 170-65901                         | 1            | 170-68X00   | ΔΔΔ-65100      |                    |              |           |
|                |                          | vlak tweevoudig                      | 170-65901                         | 2            | 170-68X00   |                |                    | ΔΔΔ-65200    |           |
|                |                          | schuin tweevoudig                    | 170-65904                         | 1            | 170-68X00   |                |                    | ΔΔΔ-65400    |           |
| Niko           | 650-45055                | vlak enkelvoudig                     | 170-65901                         | 1            | 170-68X00   | ΔΔΔ-65100      |                    |              |           |
|                |                          | vlak tweevoudig                      | 170-65901                         | 2            | 170-68X00   |                |                    | ΔΔΔ-65200    |           |
|                |                          | schuin tweevoudig                    | 170-65904                         | 1            | 170-68X00   |                |                    | ΔΔΔ-65400    |           |
| Niko           | 650-45061                | vlak enkelvoudig                     | 170-65901                         | 1            | 170-68X00   | ΔΔΔ-65100      |                    |              |           |
|                |                          | vlak tweevoudig                      | 170-65901                         | 2            | 170-68X00   |                |                    | ΔΔΔ-65200    |           |
|                |                          | schuin tweevoudig                    | 170-65904                         | 1            | 170-68X00   |                |                    | ΔΔΔ-65400    |           |
| Niko           | 650-45066                | vlak enkelvoudig                     | 170-65901                         | 1            | 170-68X00   | ΔΔΔ-65100      |                    |              |           |
|                |                          | vlak tweevoudig                      | 170-65901                         | 2            | 170-68X00   |                |                    | ΔΔΔ-65200    |           |
|                |                          | schuin tweevoudig                    | 170-65904                         | 1            | 170-68X00   |                |                    | ΔΔΔ-65400    |           |
| <b>Nexans</b>  |                          |                                      |                                   |              |   |                |                    |              |           |
| Nexans         | N420.550 *               | vlak enkelvoudig                     | 170-65101                         | 1            | 170-68X00   | ΔΔΔ-65100      |                    |              |           |
|                |                          | vlak tweevoudig                      | 170-65101                         | 2            | 170-68X00   |                |                    | ΔΔΔ-65200    |           |
| Nexans         | N420.551 *               | vlak enkelvoudig                     | 170-65101                         | 1            | 170-68X00   | ΔΔΔ-65100      |                    |              |           |
|                |                          | vlak tweevoudig                      | 170-65101                         | 2            | 170-68X00   |                |                    | ΔΔΔ-65200    |           |
| Nexans         | N420.555 *               | vlak enkelvoudig                     | 170-65101                         | 1            | 170-68X00   | ΔΔΔ-65100      |                    |              |           |
|                |                          | vlak tweevoudig                      | 170-65101                         | 2            | 170-68X00   |                |                    | ΔΔΔ-65200    |           |
| Nexans         | N420.556*                | vlak enkelvoudig                     | 170-65101                         | 1            | 170-68X00   | ΔΔΔ-65100      |                    |              |           |
|                |                          | vlak tweevoudig                      | 170-65101                         | 2            | 170-68X00   |                |                    | ΔΔΔ-65200    |           |
| Nexans         | N420.560 *               | vlak enkelvoudig                     | 170-65101                         | 1            | 170-68X00   | ΔΔΔ-65100      |                    |              |           |
|                |                          | vlak tweevoudig                      | 170-65101                         | 2            | 170-68X00   |                |                    | ΔΔΔ-65200    |           |
| Nexans         | N420.661 *               | vlak enkelvoudig                     | 170-65101                         | 1            | 170-68X00   | ΔΔΔ-65100      |                    |              |           |
|                |                          | vlak tweevoudig                      | 170-65101                         | 2            | 170-68X00   |                |                    | ΔΔΔ-65200    |           |
| Nexans         | N420.666 *               | vlak enkelvoudig                     | 170-65101                         | 1            | 170-68X00   | ΔΔΔ-65100      |                    |              |           |
|                |                          | vlak tweevoudig                      | 170-65101                         | 2            | 170-68X00   |                |                    | ΔΔΔ-65200    |           |
| Nexans         | N420.667 *               | vlak enkelvoudig                     | 170-65101                         | 1            | 170-68X00   | ΔΔΔ-65100      |                    |              |           |
|                |                          | vlak tweevoudig                      | 170-65101                         | 2            | 170-68X00   |                |                    | ΔΔΔ-65200    |           |
| Nexans         | N420.666G *              | vlak enkelvoudig                     | 170-65101                         | 1            | 170-68X00   | ΔΔΔ-65100      |                    |              |           |
|                |                          | vlak tweevoudig                      | 170-65101                         | 2            | 170-68X00   |                |                    | ΔΔΔ-65200    |           |
| Nexans         | N420.667G *              | vlak enkelvoudig                     | 170-65101                         | 1            | 170-68X00   | ΔΔΔ-65100      |                    |              |           |
|                |                          | vlak tweevoudig                      | 170-65101                         | 2            | 170-68X00   |                |                    | ΔΔΔ-65200    |           |
| Nexans         | N420.66A *               | vlak enkelvoudig                     | 170-65101                         | 1            | 170-68X00   | ΔΔΔ-65100      |                    |              |           |
|                |                          | vlak tweevoudig                      | 170-65101                         | 2            | 170-68X00   |                |                    | ΔΔΔ-65200    |           |
| Nexans         | N420.67A *               | vlak enkelvoudig                     | 170-65101                         | 1            | 170-68X00   | ΔΔΔ-65100      |                    |              |           |
|                |                          | vlak tweevoudig                      | 170-65101                         | 2            | 170-68X00   |                |                    | ΔΔΔ-65200    |           |
| Nexans         | N420.735 **              | vlak enkelvoudig                     | 170-65101                         | 1            | 170-68X00   | ΔΔΔ-65100      |                    |              |           |
|                |                          | vlak tweevoudig                      | 170-65101                         | 2            | 170-68X00   |                |                    | ΔΔΔ-65200    |           |
| Nexans         | N420.736 **              | vlak enkelvoudig                     | 170-65101                         | 1            | 170-68X00   | ΔΔΔ-65100      |                    |              |           |
|                |                          | vlak tweevoudig                      | 170-65101                         | 2            | 170-68X00   |                |                    | ΔΔΔ-65200    |           |

(\*) in combinatie met blauwe kunststof keystone clip van Nexans ref. N429.626 (24x)

(\*\*) in combinatie met metalen keystone clip van Nexans ref. N429.620 (24x)



| Merk connector | Referentie van fabrikant | Gewenste uitvoering wand-contactdoos | Ref. Passtuk of 45 x 45 mm module | # Passtukken | Inbouwraam Niko;<br>X=6 klauw-bevestiging,<br>X=7 schroef-bevestiging | cpl 1-voudig   | cpl 2-voudig       |
|----------------|--------------------------|--------------------------------------|-----------------------------------|--------------|---|----------------|--------------------|
|                |                          |                                      |                                   |              |   | ΔΔΔ Kleur      | ΔΔΔ Kleur          |
|                |                          |                                      |                                   |              |   | 100 cream      | 121 sterling       |
|                |                          |                                      |                                   |              |   | 101 white      | 122 anthracite     |
|                |                          |                                      |                                   |              |   | 102 light grey | 123 bronze         |
|                |                          |                                      |                                   |              |   | 104 greige     | 124 dark brown     |
|                |                          |                                      |                                   |              |   |                | 154 white          |
|                |                          |                                      |                                   |              |   |                | 157 champagne      |
|                |                          |                                      |                                   |              |   |                | 161 black          |
|                |                          |                                      |                                   |              |   |                | 200 piano black    |
|                |                          |                                      |                                   |              |   |                | 201 chocolate      |
|                |                          |                                      |                                   |              |   |                | 220 alu steel grey |
|                |                          |                                      |                                   |              |   |                | 221 alu gold       |
| <b>Abitana</b> |                          |                                      |                                   |              |   |                |                    |
| Abitana        | ABI-CP1001S06            | vlak enkelvoudig                     | 170-65701                         | 1            | 170-68X00   | ΔΔΔ-65100      |                    |
|                |                          | vlak tweevoudig                      | 170-65701                         | 2            | 170-68X00   |                | ΔΔΔ-65200          |
| Abitana        | ABI-CP2006S00            | vlak enkelvoudig                     | 170-65701                         | 1            | 170-68X00   | ΔΔΔ-65100      |                    |
|                |                          | vlak tweevoudig                      | 170-65701                         | 2            | 170-68X00   |                | ΔΔΔ-65200          |
| <b>Belden</b>  |                          |                                      |                                   |              |   |                |                    |
| Belden         | AX102283                 | vlak enkelvoudig                     | 170-65501                         | 1            | 170-68X00   | ΔΔΔ-65100      |                    |
|                |                          | vlak tweevoudig                      | 170-65501                         | 2            | 170-68X00   |                | ΔΔΔ-65200          |
| Belden         | AX104562                 | vlak enkelvoudig                     | 170-65501                         | 1            | 170-68X00   | ΔΔΔ-65100      |                    |
|                |                          | vlak tweevoudig                      | 170-65501                         | 2            | 170-68X00   |                | ΔΔΔ-65200          |
| Belden         | RVAMJKU_ _               | vlak enkelvoudig                     | 170-65501                         | 1            | 170-68X00   | ΔΔΔ-65100      |                    |
|                |                          | vlak tweevoudig                      | 170-65501                         | 2            | 170-68X00   |                | ΔΔΔ-65200          |
| Belden         | RV6MJKU_ _               | vlak enkelvoudig                     | 170-65501                         | 1            | 170-68X00   | ΔΔΔ-65100      |                    |
|                |                          | vlak tweevoudig                      | 170-65501                         | 2            | 170-68X00   |                | ΔΔΔ-65200          |
| Belden         | RV5MJKU_ _               | vlak enkelvoudig                     | 170-65501                         | 1            | 170-68X00   | ΔΔΔ-65100      |                    |
|                |                          | vlak tweevoudig                      | 170-65501                         | 2            | 170-68X00   |                | ΔΔΔ-65200          |
| Belden         | RVAMJKSME                | vlak enkelvoudig                     | 170-65501                         | 1            | 170-68X00   | ΔΔΔ-65100      |                    |
|                |                          | vlak tweevoudig                      | 170-65501                         | 2            | 170-68X00   |                | ΔΔΔ-65200          |
| Belden         | RV6MJKSME                | vlak enkelvoudig                     | 170-65501                         | 1            | 170-68X00   | ΔΔΔ-65100      |                    |
|                |                          | vlak tweevoudig                      | 170-65501                         | 2            | 170-68X00   |                | ΔΔΔ-65200          |
| Belden         | RV5MJKSME                | vlak enkelvoudig                     | 170-65501                         | 1            | 170-68X00   | ΔΔΔ-65100      |                    |
|                |                          | vlak tweevoudig                      | 170-65501                         | 2            | 170-68X00   |                | ΔΔΔ-65200          |
| <b>Hubbell</b> |                          |                                      |                                   |              |   |                |                    |
| Hubbell        | HXJ6_ _                  | vlak enkelvoudig                     | 170-65501                         | 1            | 170-68X00   | ΔΔΔ-65100      |                    |
|                |                          | vlak tweevoudig                      | 170-65501                         | 2            | 170-68X00   |                | ΔΔΔ-65200          |
| <b>Panduit</b> |                          |                                      |                                   |              |   |                |                    |
| Panduit        | CJ64_ _                  | vlak enkelvoudig                     | 170-65601                         | 1            | 170-68X00   | ΔΔΔ-65100      |                    |
|                |                          | vlak tweevoudig                      | 170-65601                         | 2            | 170-68X00   |                | ΔΔΔ-65200          |
| Panduit        | CJ66_ _                  | vlak enkelvoudig                     | 170-65601                         | 1            | 170-68X00   | ΔΔΔ-65100      |                    |
|                |                          | vlak tweevoudig                      | 170-65601                         | 2            | 170-68X00   |                | ΔΔΔ-65200          |
| Panduit        | CFPFS2SAW                | schuin tweevoudig                    | 45 x 45 module                    |              | 170-68X00   |                |                    |
| Panduit        | CFPFS2AW                 | schuin tweevoudig                    | 45 x 45 module                    |              | 170-68X00   |                |                    |
| Panduit        | CFPFF2AW                 | vlak tweevoudig                      | 45 x 45 module                    |              | 170-68X00   |                |                    |
| Panduit        | CFPFS1SAW                | schuin enkelvoudig                   | 45 x 45 module                    |              | 170-68X00   |                |                    |
| Panduit        | C2FPAW                   | schuin tweevoudig                    | 45 x 45 module                    |              | 170-68X00   |                |                    |
| Panduit        | CS2FPAW                  | schuin tweevoudig                    | 45 x 45 module                    |              | 170-68X00   |                |                    |
| Panduit        | CJ5E88TG_ _              | vlak enkelvoudig                     | 170-65601                         | 1            | 170-68X00   | ΔΔΔ-65100      |                    |
|                |                          | vlak tweevoudig                      | 170-65601                         | 2            | 170-68X00   |                | ΔΔΔ-65200          |
| Panduit        | CJ5E88TG                 | vlak enkelvoudig                     | 170-65601                         | 1            | 170-68X00   | ΔΔΔ-65100      |                    |
|                |                          | vlak tweevoudig                      | 170-65601                         | 2            | 170-68X00   |                | ΔΔΔ-65200          |
| Panduit        | CJ688TG_ _               | vlak enkelvoudig                     | 170-65601                         | 1            | 170-68X00   | ΔΔΔ-65100      |                    |
|                |                          | vlak tweevoudig                      | 170-65601                         | 2            | 170-68X00   |                | ΔΔΔ-65200          |
| Panduit        | CJ6X88TG_ _ (Cat. 6A)    | vlak enkelvoudig                     | 170-65601                         | 1            | 170-68X00   | ΔΔΔ-65100      |                    |
|                |                          | vlak tweevoudig                      | 170-65601                         | 2            | 170-68X00   |                | ΔΔΔ-65200          |
| Panduit        | CJS688TG                 | vlak enkelvoudig                     | 170-65601                         | 1            | 170-68X00   | ΔΔΔ-65100      |                    |
|                |                          | vlak tweevoudig                      | 170-65601                         | 2            | 170-68X00   |                | ΔΔΔ-65200          |
| Panduit        | CJS6X88TG (Cat. 6A)      | vlak enkelvoudig                     | 170-65601                         | 1            | 170-68X00   | ΔΔΔ-65100      |                    |
|                |                          | vlak tweevoudig                      | 170-65601                         | 2            | 170-68X00   |                | ΔΔΔ-65200          |
| Panduit        | CMDSC_ _ glasvezel SC    | vlak enkelvoudig                     | 170-65601                         | 1            | 170-68X00   | ΔΔΔ-65100      |                    |
|                |                          | vlak tweevoudig                      | 170-65601                         | 2            | 170-68X00   |                | ΔΔΔ-65200          |
| Panduit        | CMST_ _ glasvezel ST     | vlak enkelvoudig                     | 170-65601                         | 1            | 170-68X00   | ΔΔΔ-65100      |                    |
|                |                          | vlak tweevoudig                      | 170-65601                         | 2            | 170-68X00   |                | ΔΔΔ-65200          |

D.1

D.2

D.3

D.4

D.5

D.6



| Merk connector                       | Referentie van fabrikant | Gewenste uitvoering wand-contactdoos | Ref. Passtuk of 45 x 45 mm module | # Passtukken | Inbouwraam Niko;<br>X=6 klauw-bevestiging,<br>X=7 schroef-bevestiging | cpl 1-voudig   | cpl 2-voudig       |
|--------------------------------------|--------------------------|--------------------------------------|-----------------------------------|--------------|---|----------------|--------------------|
|                                      |                          |                                      |                                   |              |   | ΔΔΔ Kleur      | ΔΔΔ Kleur          |
|                                      |                          |                                      |                                   |              |   | 100 cream      | 121 sterling       |
|                                      |                          |                                      |                                   |              |   | 101 white      | 122 anthracite     |
|                                      |                          |                                      |                                   |              |   | 102 light grey | 123 bronze         |
|                                      |                          |                                      |                                   |              |   | 104 greige     | 124 dark brown     |
|                                      |                          |                                      |                                   |              |   |                | 154 white          |
|                                      |                          |                                      |                                   |              |   |                | 157 champagne      |
|                                      |                          |                                      |                                   |              |   |                | 161 black          |
|                                      |                          |                                      |                                   |              |   |                | 200 piano black    |
|                                      |                          |                                      |                                   |              |   |                | 201 chocolate      |
|                                      |                          |                                      |                                   |              |   |                | 220 alu steel grey |
|                                      |                          |                                      |                                   |              |   |                | 221 alu gold       |
| <b>AMP NetConnect</b>                |                          |                                      |                                   |              |   |                |                    |
| AMP NetConnect                       | 1375191-2                | vlak enkelvoudig                     | 170-65101                         | 1            | 170-68X00   | ΔΔΔ-65100      |                    |
|                                      |                          | vlak tweevoudig                      | 170-65101                         | 2            | 170-68X00   |                | ΔΔΔ-65200          |
| AMP NetConnect                       | 1375189-1                | vlak enkelvoudig                     | 170-65101                         | 1            | 170-68X00   | ΔΔΔ-65100      |                    |
|                                      |                          | vlak tweevoudig                      | 170-65101                         | 2            | 170-68X00   |                | ΔΔΔ-65200          |
| AMP NetConnect                       | 1375055-2                | vlak enkelvoudig                     | 170-65101                         | 1            | 170-68X00   | ΔΔΔ-65100      |                    |
|                                      |                          | vlak tweevoudig                      | 170-65101                         | 2            | 170-68X00   |                | ΔΔΔ-65200          |
| AMP NetConnect                       | 1375187-2                | vlak enkelvoudig                     | 170-65101                         | 1            | 170-68X00   | ΔΔΔ-65100      |                    |
|                                      |                          | vlak tweevoudig                      | 170-65101                         | 2            | 170-68X00   |                | ΔΔΔ-65200          |
| AMP NetConnect                       | 1933476-2                | vlak enkelvoudig                     | 170-65101                         | 1            | 170-68X00   | ΔΔΔ-65100      |                    |
|                                      |                          | vlak tweevoudig                      | 170-65101                         | 2            | 170-68X00   |                | ΔΔΔ-65200          |
| AMP NetConnect                       | 2111676-2                | vlak enkelvoudig                     | 170-65101                         | 1            | 170-68X00   | ΔΔΔ-65100      |                    |
|                                      |                          | vlak tweevoudig                      | 170-65101                         | 2            | 170-68X00   |                | ΔΔΔ-65200          |
| AMP NetConnect                       | 2153001-1                | vlak enkelvoudig                     | 170-65101                         | 1            | 170-68X00   | ΔΔΔ-65100      |                    |
|                                      |                          | vlak tweevoudig                      | 170-65101                         | 2            | 170-68X00   |                | ΔΔΔ-65200          |
| AMP NetConnect                       | 2153000-1                | vlak enkelvoudig                     | 170-65101                         | 1            | 170-68X00   | ΔΔΔ-65100      |                    |
|                                      |                          | vlak tweevoudig                      | 170-65101                         | 2            | 170-68X00   |                | ΔΔΔ-65200          |
| AMP NetConnect                       | 1711716-1                | vlak enkelvoudig                     | 170-65101                         | 1            | 170-68X00   | ΔΔΔ-65100      |                    |
|                                      |                          | vlak tweevoudig                      | 170-65101                         | 2            | 170-68X00   |                | ΔΔΔ-65200          |
| AMP NetConnect                       | 1711592-1                | vlak enkelvoudig                     | 170-65101                         | 1            | 170-68X00   | ΔΔΔ-65100      |                    |
|                                      |                          | vlak tweevoudig                      | 170-65101                         | 2            | 170-68X00   |                | ΔΔΔ-65200          |
| AMP NetConnect                       | 1711342-1                | vlak enkelvoudig                     | 170-65101                         | 1            | 170-68X00   | ΔΔΔ-65100      |                    |
|                                      |                          | vlak tweevoudig                      | 170-65101                         | 2            | 170-68X00   |                | ΔΔΔ-65200          |
| AMP NetConnect                       | 1711160-1                | vlak enkelvoudig                     | 170-65101                         | 1            | 170-68X00   | ΔΔΔ-65100      |                    |
|                                      |                          | vlak tweevoudig                      | 170-65101                         | 2            | 170-68X00   |                | ΔΔΔ-65200          |
| Stofklepje verwijderen voor montage! |                          |                                      |                                   |              |   |                |                    |
| <b>Systemax</b>                      |                          |                                      |                                   |              |   |                |                    |
| Systemax                             | MPS100E-262              | vlak enkelvoudig                     | 170-65201                         | 1            | 170-68X00   | ΔΔΔ-65100      |                    |
|                                      |                          | vlak tweevoudig                      | 170-65201                         | 2            | 170-68X00   |                | ΔΔΔ-65200          |
| Systemax                             | MPS100E-003              | vlak enkelvoudig                     | 170-65201                         | 1            | 170-68X00   | ΔΔΔ-65100      |                    |
|                                      |                          | vlak tweevoudig                      | 170-65201                         | 2            | 170-68X00   |                | ΔΔΔ-65200          |
| Systemax                             | MGS400-262               | vlak enkelvoudig                     | 170-65201                         | 1            | 170-68X00   | ΔΔΔ-65100      |                    |
|                                      |                          | vlak tweevoudig                      | 170-65201                         | 2            | 170-68X00   |                | ΔΔΔ-65200          |
| Systemax                             | MGS400-003               | vlak enkelvoudig                     | 170-65201                         | 1            | 170-68X00   | ΔΔΔ-65100      |                    |
|                                      |                          | vlak tweevoudig                      | 170-65201                         | 2            | 170-68X00   |                | ΔΔΔ-65200          |
| Systemax                             | MGS600-262               | vlak enkelvoudig                     | 170-65201                         | 1            | 170-68X00   | ΔΔΔ-65100      |                    |
|                                      |                          | vlak tweevoudig                      | 170-65201                         | 2            | 170-68X00   |                | ΔΔΔ-65200          |
| Systemax                             | MGS600-003               | vlak enkelvoudig                     | 170-65201                         | 1            | 170-68X00   | ΔΔΔ-65100      |                    |
|                                      |                          | vlak tweevoudig                      | 170-65201                         | 2            | 170-68X00   |                | ΔΔΔ-65200          |
| Systemax                             | HGS620                   | vlak enkelvoudig                     | 170-65201                         | 1            | 170-68X00   | ΔΔΔ-65100      |                    |
|                                      |                          | vlak tweevoudig                      | 170-65201                         | 2            | 170-68X00   |                | ΔΔΔ-65200          |
| <b>Siemon</b>                        |                          |                                      |                                   |              |   |                |                    |
| Siemon                               | MX5-K(XX)                | vlak enkelvoudig                     | 170-65101                         | 1            | 170-68X00   | ΔΔΔ-65100      |                    |
|                                      |                          | vlak tweevoudig                      | 170-65101                         | 2            | 170-68X00   |                | ΔΔΔ-65200          |
| Siemon                               | MX-K-C5-(XX)             | vlak enkelvoudig                     | 170-65101                         | 1            | 170-68X00   | ΔΔΔ-65100      |                    |
|                                      |                          | vlak tweevoudig                      | 170-65101                         | 2            | 170-68X00   |                | ΔΔΔ-65200          |
| Siemon                               | MX6-K(XX)                | vlak enkelvoudig                     | 170-65101                         | 1            | 170-68X00   | ΔΔΔ-65100      |                    |
|                                      |                          | vlak tweevoudig                      | 170-65101                         | 2            | 170-68X00   |                | ΔΔΔ-65200          |

| Merk connector      | Referentie van fabrikant         | Gewenste uitvoering wand-contactdoos | Ref. Passtuk of 45 x 45 mm module | # Passtukken | Inbouwraam Niko;<br>X=6 klauw-bevestiging,<br>X=7 schroef-bevestiging | cpl 1-voudig   | cpl 2-voudig  |
|---------------------|----------------------------------|--------------------------------------|-----------------------------------|--------------|---|--|---|
|                     |                                  |                                      |                                   |              |   | ΔΔΔ Kleur  | ΔΔΔ Kleur   |
|                     |                                  |                                      |                                   |              |   | 100 cream<br>101 white<br>102 light grey<br>104 greige | 121 sterling<br>122 anthracite<br>123 bronze<br>124 dark brown<br>154 white<br>157 champagne<br>161 black<br>200 piano black<br>201 chocolate<br>220 alu steel grey<br>221 alu gold |
| <b>R&amp;M</b>      |                                  |                                      |                                   |              |   |  |   |
| R&M                 | 313330                           | vlak enkelvoudig                     | 45 x 45 module                    |              | 170-68X00   |  |   |
| R&M                 | 313331                           | vlak tweevoudig                      | 45 x 45 module                    |              | 170-68X00   |  |   |
| R&M                 | 313332                           | vlak enkelvoudig                     | 45 x 45 module                    |              | 170-68X00   |  |   |
| R&M                 | 313333                           | vlak tweevoudig                      | 45 x 45 module                    |              | 170-68X00   |  |   |
| R&M                 | R813512                          | vlak enkelvoudig                     | 170-65501                         | 1            | 170-68X00   | ΔΔΔ-65100  |   |
|                     |                                  | vlak tweevoudig                      | 170-65501                         | 2            | 170-68X00   |  | ΔΔΔ-65200   |
| R&M                 | R813514                          | vlak enkelvoudig                     | 170-65501                         | 1            | 170-68X00   | ΔΔΔ-65100  |   |
|                     |                                  | vlak tweevoudig                      | 170-65501                         | 2            | 170-68X00   |  | ΔΔΔ-65200   |
| <b>Radiall</b>      |                                  |                                      |                                   |              |   |  |   |
| Radiall             | R280MOD804A                      | vlak enkelvoudig                     | 170-65501                         | 1            | 170-68X00   | ΔΔΔ-65100  |   |
| Radiall             | R280MOD805A                      | vlak enkelvoudig                     | 170-65501                         | 1            | 170-68X00   | ΔΔΔ-65100  |   |
| Radiall             | R280MOD807                       | vlak enkelvoudig                     | 170-65501                         | 1            | 170-68X00   | ΔΔΔ-65100  |   |
|                     |                                  | vlak tweevoudig                      | 170-65501                         | 2            | 170-68X00   |  | ΔΔΔ-65200   |
| Radiall             | R280MOD812                       | vlak enkelvoudig                     | 170-65501                         | 1            | 170-68X00   | ΔΔΔ-65100  |   |
| Radiall             | R280MOD803                       | vlak enkelvoudig                     | 170-65501                         | 1            | 170-68X00   | ΔΔΔ-65100  |   |
|                     |                                  | vlak tweevoudig                      | 170-65501                         | 2            | 170-68X00   |  | ΔΔΔ-65200   |
| Radiall             | R280MOD800                       | vlak enkelvoudig                     | 170-65501                         | 1            | 170-68X00   | ΔΔΔ-65100  |   |
|                     |                                  | vlak tweevoudig                      | 170-65501                         | 2            | 170-68X00   |  | ΔΔΔ-65200   |
| <b>Leoni-Kerpen</b> |                                  |                                      |                                   |              |   |  |   |
| Leoni-Kerpen        | Megaline Connect 45              | vlak enkelvoudig                     | 170-65501                         | 1            | 170-68X00   | ΔΔΔ-65100  |   |
|                     |                                  | vlak tweevoudig                      | 170-65501                         | 2            | 170-68X00   |  | ΔΔΔ-65200   |
| <b>Brand-Rex</b>    |                                  |                                      |                                   |              |   |  |   |
| Brand-Rex           | GigaPlus GIG 0140 - GPCJAKU002   | vlak enkelvoudig                     | 170-65101                         | 1            | 170-68X00   | ΔΔΔ-65100  |   |
|                     |                                  | vlak tweevoudig                      | 170-65101                         | 2            | 170-68X00   |  | ΔΔΔ-65200   |
| Brand-Rex           | 10GPlus BCA 0140 - AC6JAKU002    | vlak enkelvoudig                     | 170-65101                         | 1            | 170-68X00   | ΔΔΔ-65100  |   |
|                     |                                  | vlak tweevoudig                      | 170-65101                         | 2            | 170-68X00   |  | ΔΔΔ-65200   |
| Brand-Rex           | 10GPlus BCA 0170 - AC6JAKS000DC  | vlak enkelvoudig                     | 170-65101                         | 1            | 170-68X00   | ΔΔΔ-65100  |   |
|                     |                                  | vlak tweevoudig                      | 170-65101                         | 2            | 170-68X00   |  | ΔΔΔ-65200   |
| Brand-Rex           | Cat6Plus BBR 0140 - C6CJAKU002   | vlak enkelvoudig                     | 170-65101                         | 1            | 170-68X00   | ΔΔΔ-65100  |   |
|                     |                                  | vlak tweevoudig                      | 170-65101                         | 2            | 170-68X00   |  | ΔΔΔ-65200   |
| Brand-Rex           | Cat6Plus BBR 0170 - C6CJAKS000DC | vlak enkelvoudig                     | 170-65101                         | 1            | 170-68X00   | ΔΔΔ-65100  |   |
|                     |                                  | vlak tweevoudig                      | 170-65101                         | 2            | 170-68X00   |  | ΔΔΔ-65200   |
| <b>AT&amp;T</b>     |                                  |                                      |                                   |              |   |  |   |
| AT&T                | AKD 0102 - 15A5ENV008A-WL61      | vlak enkelvoudig                     | 170-65101                         | 1            | 170-68X00   | ΔΔΔ-65100  |   |
|                     |                                  | vlak tweevoudig                      | 170-65101                         | 2            | 170-68X00   |  | ΔΔΔ-65200   |
| AT&T                | AKD 0112 - 15C5ENV008A-ML61      | vlak enkelvoudig                     | 170-65101                         | 1            | 170-68X00   | ΔΔΔ-65100  |   |
|                     |                                  | vlak tweevoudig                      | 170-65101                         | 2            | 170-68X00   |  | ΔΔΔ-65200   |
| AT&T                | AKE 0120 - 15A06NV008A-WB61      | vlak enkelvoudig                     | 170-65101                         | 1            | 170-68X00   | ΔΔΔ-65100  |   |
|                     |                                  | vlak tweevoudig                      | 170-65101                         | 2            | 170-68X00   |  | ΔΔΔ-65200   |
| AT&T                | AKE 0130 - 15C06NV008A-MB61      | vlak enkelvoudig                     | 170-65101                         | 1            | 170-68X00   | ΔΔΔ-65100  |   |
|                     |                                  | vlak tweevoudig                      | 170-65101                         | 2            | 170-68X00   |  | ΔΔΔ-65200   |
| AT&T                | AKF 0140 - 15A6ANV008A-WK61      | vlak enkelvoudig                     | 170-65101                         | 1            | 170-68X00   | ΔΔΔ-65100  |   |
|                     |                                  | vlak tweevoudig                      | 170-65101                         | 2            | 170-68X00   |  | ΔΔΔ-65200   |
| AT&T                | AKF 0170 - 15C6ANV008A-MK61      | vlak enkelvoudig                     | 170-65101                         | 1            | 170-68X00   | ΔΔΔ-65100  |   |
|                     |                                  | vlak tweevoudig                      | 170-65101                         | 2            | 170-68X00   |  | ΔΔΔ-65200   |

D.1

D.2

D.3

D.4

D.5

D.6



| Merk connector                       | Referentie van fabrikant | Gewenste uitvoering wand-contactdoos | Ref. Passtuk of 45 x 45 mm module | # Passtukken | Inbouwraam Niko; X=6 klauw-bevestiging, X=7 schroef-bevestiging | cpl 1-voudig   | cpl 2-voudig  |
|--------------------------------------|--------------------------|--------------------------------------|-----------------------------------|--------------|---|--|---|
|                                      |                          |                                      |                                   |              |   | ΔΔΔ Kleur  | ΔΔΔ Kleur   |
|                                      |                          |                                      |                                   |              |   | 100 cream<br>101 white<br>102 light grey<br>104 greige | 121 sterling<br>122 anthracite<br>123 bronze<br>124 dark brown<br>154 white<br>157 champagne<br>161 black<br>200 piano black<br>201 chocolate<br>220 alu steel grey<br>221 alu gold |
| <b>Leviton</b>                       |                          |                                      |                                   |              |   |  |   |
| Leviton                              | 5G110                    | vlak enkelvoudig                     | 170-65101                         | 1            | 170-68X00   | ΔΔΔ-65100  |   |
|                                      |                          | vlak tweevoudig                      | 170-65101                         | 2            | 170-68X00   |  | ΔΔΔ-65200   |
| Leviton                              | 5EUJK                    | vlak enkelvoudig                     | 170-65101                         | 1            | 170-68X00   | ΔΔΔ-65100  |   |
|                                      |                          | vlak tweevoudig                      | 170-65101                         | 2            | 170-68X00   |  | ΔΔΔ-65200   |
| Leviton                              | 5ESJK                    | vlak enkelvoudig                     | 170-65101                         | 1            | 170-68X00   | ΔΔΔ-65100  |   |
|                                      |                          | vlak tweevoudig                      | 170-65101                         | 2            | 170-68X00   |  | ΔΔΔ-65200   |
| Leviton                              | 61110                    | vlak enkelvoudig                     | 170-65101                         | 1            | 170-68X00   | ΔΔΔ-65100  |   |
|                                      |                          | vlak tweevoudig                      | 170-65101                         | 2            | 170-68X00   |  | ΔΔΔ-65200   |
| Leviton                              | 61UJK                    | vlak enkelvoudig                     | 170-65101                         | 1            | 170-68X00   | ΔΔΔ-65100  |   |
|                                      |                          | vlak tweevoudig                      | 170-65101                         | 2            | 170-68X00   |  | ΔΔΔ-65200   |
| Leviton                              | 61SJK                    | vlak enkelvoudig                     | 170-65101                         | 1            | 170-68X00   | ΔΔΔ-65100  |   |
|                                      |                          | vlak tweevoudig                      | 170-65101                         | 2            | 170-68X00   |  | ΔΔΔ-65200   |
| Leviton                              | 6110G                    | vlak enkelvoudig                     | 170-65101                         | 1            | 170-68X00   | ΔΔΔ-65100  |   |
|                                      |                          | vlak tweevoudig                      | 170-65101                         | 2            | 170-68X00   |  | ΔΔΔ-65200   |
| Leviton                              | 6AUJK                    | vlak enkelvoudig                     | 170-65101                         | 1            | 170-68X00   | ΔΔΔ-65100  |   |
|                                      |                          | vlak tweevoudig                      | 170-65101                         | 2            | 170-68X00   |  | ΔΔΔ-65200   |
| Leviton                              | 6ASJK                    | vlak enkelvoudig                     | 170-65101                         | 1            | 170-68X00   | ΔΔΔ-65100  |   |
|                                      |                          | vlak tweevoudig                      | 170-65101                         | 2            | 170-68X00   |  | ΔΔΔ-65200   |
| <b>Corning</b>                       |                          |                                      |                                   |              |   |  |   |
| Corning                              | FutureCom xs500          | vlak enkelvoudig                     | 170-65501                         | 1            | 170-68X00   | ΔΔΔ-65100  |   |
|                                      |                          | vlak tweevoudig                      | 170-65501                         | 2            | 170-68X00   |  | ΔΔΔ-65200   |
| Stofklepje verwijderen voor montage! |                          |                                      |                                   |              |   |  |   |
| <b>Multimedia Connect (MMC)</b>      |                          |                                      |                                   |              |   |  |   |
| Multimedia Connect                   | ECONN5ENB                | vlak enkelvoudig                     | 170-65701                         | 1            | 170-68X00   | ΔΔΔ-65100  |   |
|                                      |                          | vlak tweevoudig                      | 170-65701                         | 2            | 170-68X00   |  | ΔΔΔ-65200   |
| Multimedia Connect                   | ECONN6AFS                | vlak enkelvoudig                     | 170-65701                         | 1            | 170-68X00   | ΔΔΔ-65100  |   |
|                                      |                          | vlak tweevoudig                      | 170-65701                         | 2            | 170-68X00   |  | ΔΔΔ-65200   |
| Multimedia Connect                   | ECONN6FS                 | vlak enkelvoudig                     | 170-65701                         | 1            | 170-68X00   | ΔΔΔ-65100  |   |
|                                      |                          | vlak tweevoudig                      | 170-65701                         | 2            | 170-68X00   |  | ΔΔΔ-65200   |
| Multimedia Connect                   | MK6NB                    | vlak enkelvoudig                     | 170-65701                         | 1            | 170-68X00   | ΔΔΔ-65100  |   |
|                                      |                          | vlak tweevoudig                      | 170-65701                         | 2            | 170-68X00   |  | ΔΔΔ-65200   |
| Multimedia Connect                   | MK6AN                    | vlak enkelvoudig                     | 170-65701                         | 1            | 170-68X00   | ΔΔΔ-65100  |   |
|                                      |                          | vlak tweevoudig                      | 170-65701                         | 2            | 170-68X00   |  | ΔΔΔ-65200   |
| Multimedia Connect                   | MK6FS                    | vlak enkelvoudig                     | 170-65701                         | 1            | 170-68X00   | ΔΔΔ-65100  |   |
|                                      |                          | vlak tweevoudig                      | 170-65701                         | 2            | 170-68X00   |  | ΔΔΔ-65200   |
| Multimedia Connect                   | MK6ANB                   | vlak enkelvoudig                     | 170-65701                         | 1            | 170-68X00   | ΔΔΔ-65100  |   |
|                                      |                          | vlak tweevoudig                      | 170-65701                         | 2            | 170-68X00   |  | ΔΔΔ-65200   |
| Multimedia Connect                   | MK6AFS                   | vlak enkelvoudig                     | 170-65701                         | 1            | 170-68X00   | ΔΔΔ-65100  |   |
|                                      |                          | vlak tweevoudig                      | 170-65701                         | 2            | 170-68X00   |  | ΔΔΔ-65200   |
| Multimedia Connect                   | BC5ENB                   | vlak enkelvoudig                     | 170-65701                         | 1            | 170-68X00   | ΔΔΔ-65100  |   |
|                                      |                          | vlak tweevoudig                      | 170-65701                         | 2            | 170-68X00   |  | ΔΔΔ-65200   |
| Multimedia Connect                   | BC5FS(TL)                | vlak enkelvoudig                     | 170-65701                         | 1            | 170-68X00   | ΔΔΔ-65100  |   |
|                                      |                          | vlak tweevoudig                      | 170-65701                         | 2            | 170-68X00   |  | ΔΔΔ-65200   |
| Multimedia Connect                   | BC6NB                    | vlak enkelvoudig                     | 170-65701                         | 1            | 170-68X00   | ΔΔΔ-65100  |   |
|                                      |                          | vlak tweevoudig                      | 170-65701                         | 2            | 170-68X00   |  | ΔΔΔ-65200   |
| Multimedia Connect                   | BC6FS(TL)                | vlak enkelvoudig                     | 170-65701                         | 1            | 170-68X00   | ΔΔΔ-65100  |   |
|                                      |                          | vlak tweevoudig                      | 170-65701                         | 2            | 170-68X00   |  | ΔΔΔ-65200   |
| Multimedia Connect                   | BC6AFS(TL)               | vlak enkelvoudig                     | 170-65701                         | 1            | 170-68X00   | ΔΔΔ-65100  |   |
|                                      |                          | vlak tweevoudig                      | 170-65701                         | 2            | 170-68X00   |  | ΔΔΔ-65200   |
| Multimedia Connect                   | IV6AFS                   | vlak enkelvoudig                     | 170-65701                         | 1            | 170-68X00   | ΔΔΔ-65100  |   |
|                                      |                          | vlak tweevoudig                      | 170-65701                         | 2            | 170-68X00   |  | ΔΔΔ-65200   |

Stofklepje verwijderen voor montage!

| Merk connector   | Referentie van fabrikant | Gewenste uitvoering wand-contactdoos | Ref. Passtuk of 45 x 45 mm module | # Passtukken | Inbouwraam Niko;<br>X=6 klauw-bevestiging,<br>X=7 schroef-bevestiging | cpl 1-voudig   |                    | cpl 2-voudig |           |
|------------------|--------------------------|--------------------------------------|-----------------------------------|--------------|---|----------------|--------------------|--------------|-----------|
|                  |                          |                                      |                                   |              |   | ΔΔΔ Kleur      | ΔΔΔ Kleur          | ΔΔΔ Kleur    | ΔΔΔ Kleur |
|                  |                          |                                      |                                   |              |   | 100 cream      | 121 sterling       |              |           |
|                  |                          |                                      |                                   |              |   | 101 white      | 122 anthracite     |              |           |
|                  |                          |                                      |                                   |              |   | 102 light grey | 123 bronze         |              |           |
|                  |                          |                                      |                                   |              |   | 104 greige     | 124 dark brown     |              |           |
|                  |                          |                                      |                                   |              |   |                | 154 white          |              |           |
|                  |                          |                                      |                                   |              |   |                | 157 champagne      |              |           |
|                  |                          |                                      |                                   |              |   |                | 161 black          |              |           |
|                  |                          |                                      |                                   |              |   |                | 200 piano black    |              |           |
|                  |                          |                                      |                                   |              |   |                | 201 chocolate      |              |           |
|                  |                          |                                      |                                   |              |   |                | 220 alu steel grey |              |           |
|                  |                          |                                      |                                   |              |   |                | 221 alu gold       |              |           |
| <b>Molex</b>     |                          |                                      |                                   |              |   |                |                    |              |           |
| Molex            | KSJ-00033-02             | vlak enkelvoudig                     | 170-65701                         | 1            | 170-68X00   | ΔΔΔ-65100      |                    |              |           |
|                  |                          | vlak tweevoudig                      | 170-65701                         | 2            | 170-68X00   |                |                    | ΔΔΔ-65200    |           |
| Molex            | KSJ-00079                | vlak enkelvoudig                     | 170-65701                         | 1            | 170-68X00   | ΔΔΔ-65100      |                    |              |           |
|                  |                          | vlak tweevoudig                      | 170-65701                         | 2            | 170-68X00   |                |                    | ΔΔΔ-65200    |           |
| <b>Optronics</b> |                          |                                      |                                   |              |   |                |                    |              |           |
| Optronics        | 500-101                  | vlak enkelvoudig                     | 170-65701                         | 1            | 170-68X00   | ΔΔΔ-65100      |                    |              |           |
|                  |                          | vlak tweevoudig                      | 170-65701                         | 2            | 170-68X00   |                |                    | ΔΔΔ-65200    |           |
| Optronics        | 501-101                  | vlak enkelvoudig                     | 170-65701                         | 1            | 170-68X00   | ΔΔΔ-65100      |                    |              |           |
|                  |                          | vlak tweevoudig                      | 170-65701                         | 2            | 170-68X00   |                |                    | ΔΔΔ-65200    |           |
| Optronics        | 600-101                  | vlak enkelvoudig                     | 170-65701                         | 1            | 170-68X00   | ΔΔΔ-65100      |                    |              |           |
|                  |                          | vlak tweevoudig                      | 170-65701                         | 2            | 170-68X00   |                |                    | ΔΔΔ-65200    |           |
| Optronics        | 601-101                  | vlak enkelvoudig                     | 170-65701                         | 1            | 170-68X00   | ΔΔΔ-65100      |                    |              |           |
|                  |                          | vlak tweevoudig                      | 170-65701                         | 2            | 170-68X00   |                |                    | ΔΔΔ-65200    |           |
| Optronics        | 800-101                  | vlak enkelvoudig                     | 170-65701                         | 1            | 170-68X00   | ΔΔΔ-65100      |                    |              |           |
|                  |                          | vlak tweevoudig                      | 170-65701                         | 2            | 170-68X00   |                |                    | ΔΔΔ-65200    |           |
| <b>Eurolan</b>   |                          |                                      |                                   |              |   |                |                    |              |           |
| Eurolan          | 16B-U6-03BL              | vlak enkelvoudig                     | 170-65701                         | 1            | 170-68X00   | ΔΔΔ-65100      |                    |              |           |
|                  |                          | vlak tweevoudig                      | 170-65701                         | 2            | 170-68X00   |                |                    | ΔΔΔ-65200    |           |
| <b>Gigamedia</b> |                          |                                      |                                   |              |   |                |                    |              |           |
| Gigamedia        | GGM PRJCxxx              | vlak enkelvoudig                     | 170-65501                         | 1            | 170-68X00   | ΔΔΔ-65100      |                    |              |           |
|                  |                          | vlak tweevoudig                      | 170-65501                         | 2            | 170-68X00   |                |                    | ΔΔΔ-65200    |           |

D.1

D.2

D.3

D.4

D.5

D.6

**Aansluiting TV, radio en satelliet**

**Enkelvoudige aansluiting in de woning:**



170-09121  
Enkelvoudige aansluiting,  
aansluitdemping < 1 dB



170-79501 & 170-09531  
Enkelvoudige aansluiting EDU,  
aansluitdemping: TV < 1 dB, FM < 3 dB

**Meerdere aansluitingen in de woning met contactdozen TV + FM**

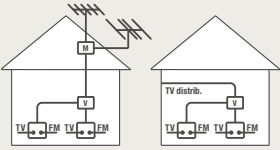

170-79501  
Tweevoudige aansluiting EDU,  
aansluitdemping: TV < 1 dB, FM < 3 dB



170-79601  
Meervoudige aansluiting GEDU,  
aansluitdemping: TV/ FM 15 dB ± 1 dB,  
doorgangsdemping < 1 dB

+ 170-29601  
Afluitweerstand voor weerkaatsingvrij  
afsluiten van een meervoudige aansluiting

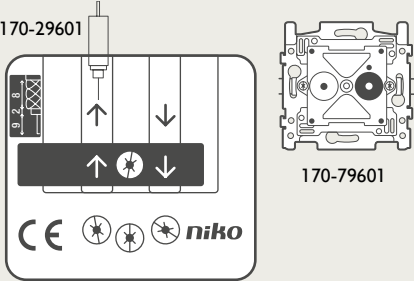

170-29601

170-79601

**Enkele of meerdere contactdozen met satelliet aansluiting**



170-79551  
Enkelvoudige aansluiting SATELLIET,  
aansluitdemping:  
TV < 1 dB (5 - 75 MHz), 1,5 dB ± 1 dB (125 - 860 MHz);  
FM < 3 dB; Sat. 2,5 dB ± 1 dB

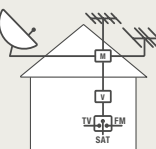

170-79551  
Enkelvoudige aansluiting SATELLIET,  
aansluitdemping:  
TV < 1 dB (5 - 75 MHz), 1,5 dB ± 1 dB (125 - 860 MHz);  
FM < 3 dB; Sat. 2,5 dB ± 1 dB

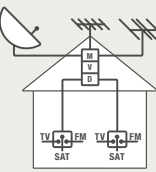

170-79551  
Tweevoudige aansluiting SATELLIET,  
aansluitdemping:  
TV < 1 dB (5 - 75 MHz), 1,5 dB ± 1 dB (125 - 860 MHz);  
FM < 3 dB; Sat. 2,5 dB ± 1 dB

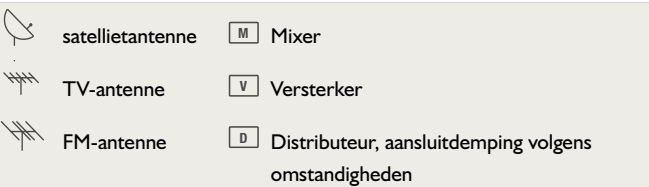

satellietantenne

TV-antenne

FM-antenne

Mixer

Versterker

Distributeur, aansluitdemping volgens omstandigheden

Zorg ervoor dat de aansluiting gebeurt volgens onderstaande tekening. Een foute aansluiting kan storingen veroorzaken. Controle kan gebeuren met multimeter door kortsluiting uit te sluiten tussen afscherming en centergeleider.

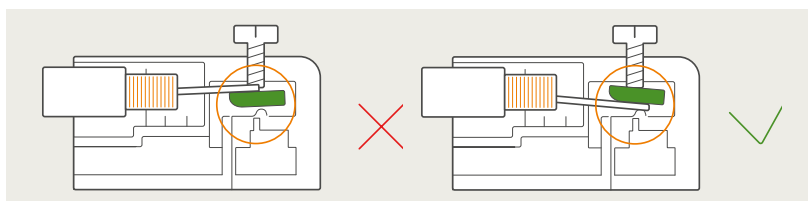

|           | Coax           | Att.<br>dB      | Return signals<br>5 - 30 MHz | Band 1<br>47 - 75 MHz | FM band<br>88 - 108 MHz | VHF<br>125 - 450 MHz | UHF<br>450 - 860 MHz | Sat.<br>950 - 2150 MHz | DC 1 A<br>18 Vdc |
|-----------|----------------|-----------------|------------------------------|-----------------------|-------------------------|----------------------|----------------------|------------------------|------------------|
| 170-79501 | ⓐ              | i < 1 dB        |                              |                       |                         |                      |                      |                        |                  |
| 170-09531 | ⓑ              | i < 3 dB        |                              |                       |                         |                      |                      |                        |                  |
| 170-79601 | ⓒ              | i 15 dB ± 1 dB  |                              |                       |                         |                      |                      |                        |                  |
|           | ⓓ              | i 15 dB ± 1 dB  |                              |                       |                         |                      |                      |                        |                  |
|           | Insertion loss | i < 1 dB        |                              |                       |                         |                      |                      |                        |                  |
| 170-79551 | ⓔ              | i < 1 dB        |                              |                       |                         |                      |                      |                        |                  |
|           | ⓕ              | i 1,5 db ± 1 dB |                              |                       |                         |                      |                      |                        |                  |
|           | Sat. type F    | i 2,5 dB ± 1 dB |                              |                       |                         |                      |                      |                        |                  |
| 170-09121 | ⓖ              | i < 1dB         |                              |                       |                         |                      |                      |                        |                  |

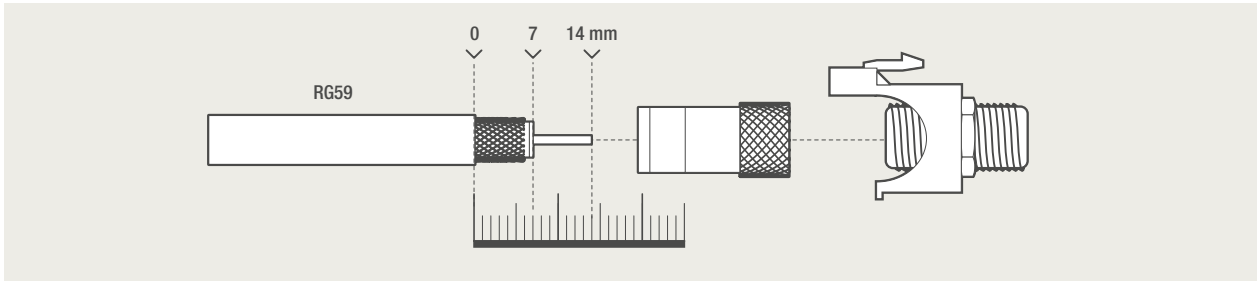
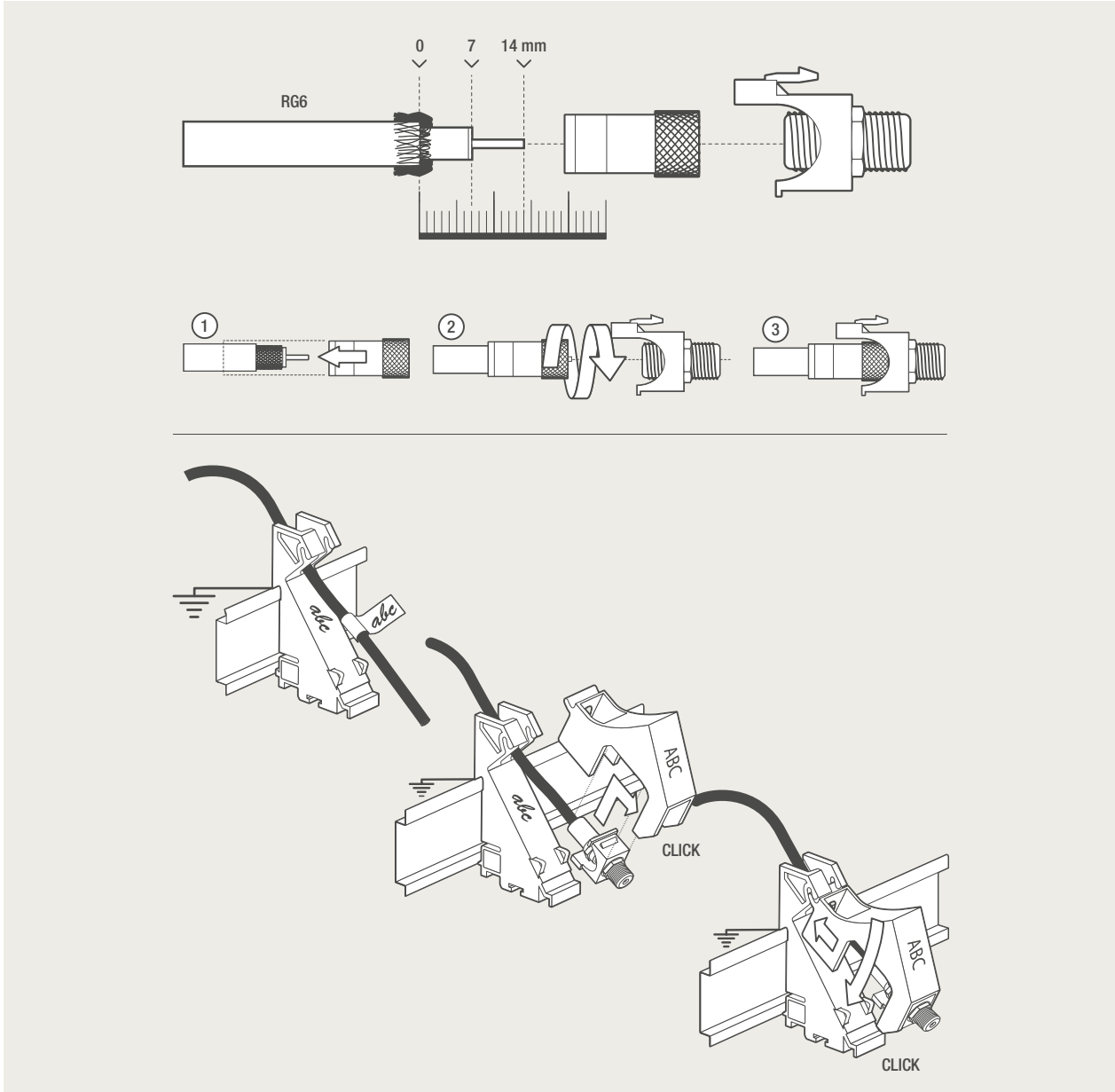
**650-16900 Coax F-connector TV (RG59)****650-16910 Coax F-connector TV + SAT (RG6)**

D.1

D.2

D.3

D.4

D.5

D.6

**ADSL-splitter**

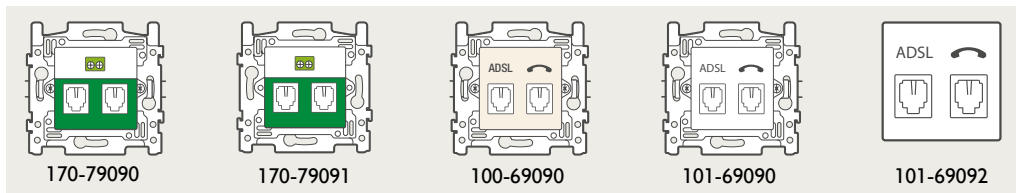

**Vroeger**

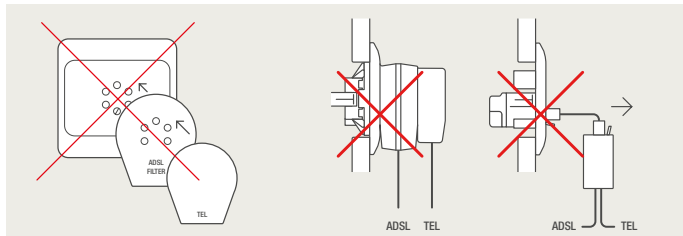

**Nu**

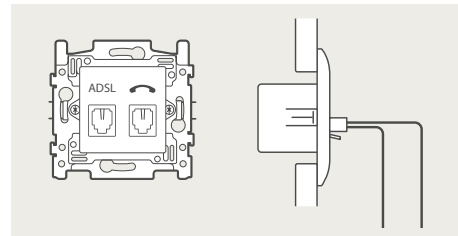

**Technische kenmerken Niko ADSL-splitter**

- Conform de specificaties voor het Proximus telefoonnetwerk
- In overeenstemming met de ETSI-standaard TS101952-1-5, optie B
- Conform de specificaties voor het Franse ADSL-netwerk
- CE-gekeurd
- EN60950-1
- Geschikt voor de volgende ADSL-generaties: ADSL, ADSL2, ADSL2+ en VDSL2 (standaard ITU G.6.993.2). Niet geschikt voor o.a. ISDN, SDL, SHDL.
- Een goede werking kan niet meer gegarandeerd worden wanneer de splitter gebruikt wordt in combinatie met andere ADSL-filters die niet aan de ET-SI-standaard TS101952-1-5, optie B voldoen.

**Bedrading en montage**

170-79090 / 170-79091 / 100-69090 / 101-69090 / 101-69092

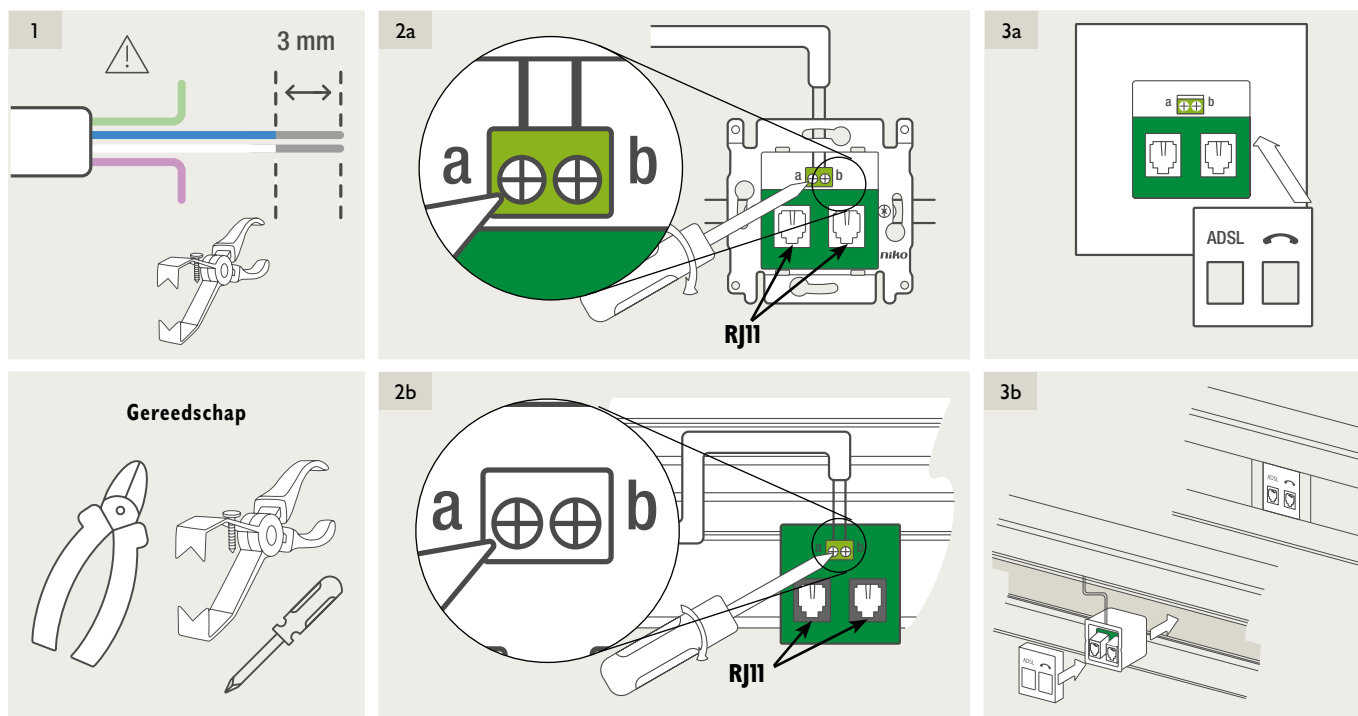



## montagevoorbeelden

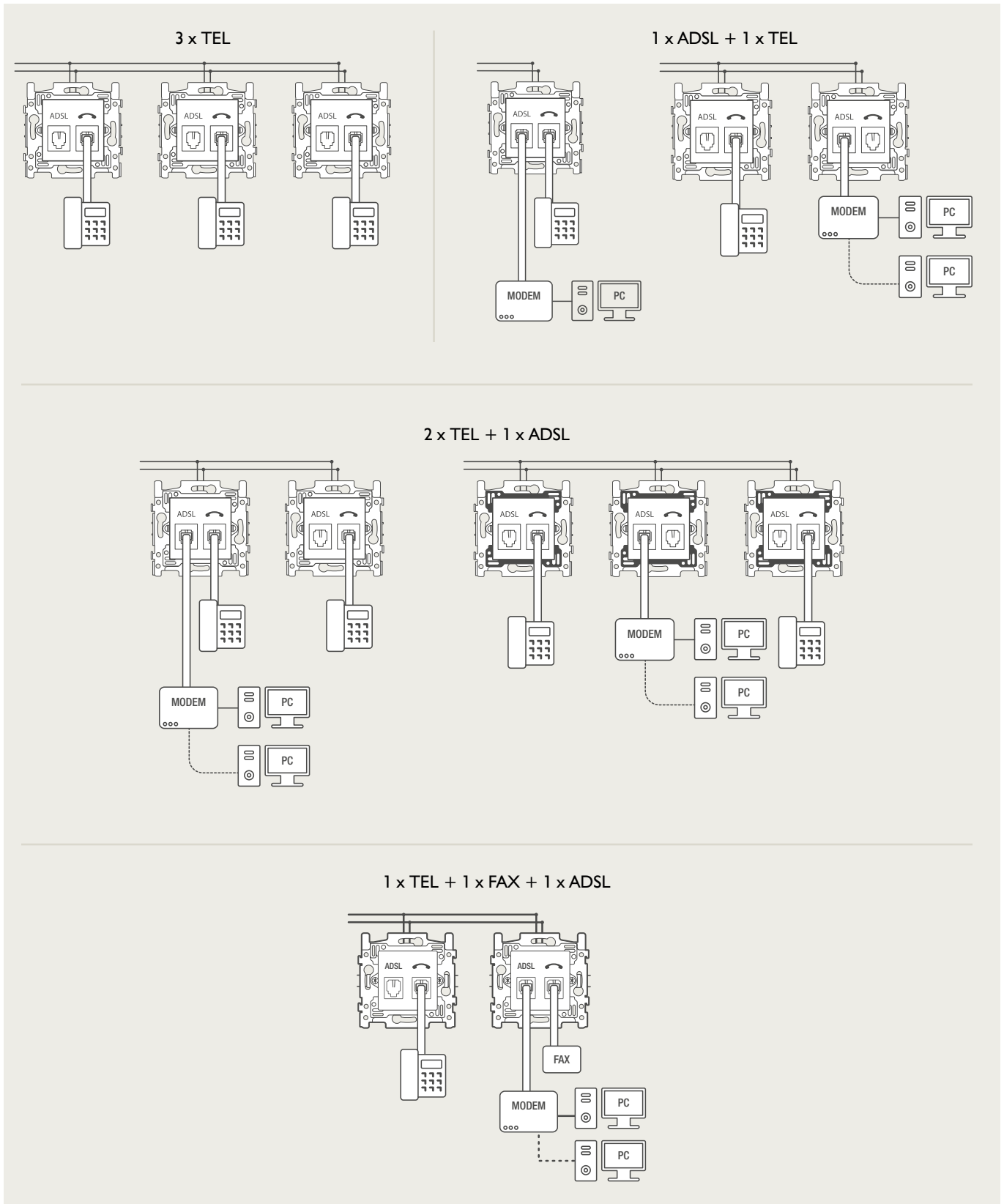

Er mogen max. 3 ADSL-splitters in parallel geplaatst worden waarop max. 1 ADSL-modem mag aangesloten worden. Telefoontoestellen worden parallel geschakeld.

D.1  
D.2  
D.3  
D.4  
D.5  
D.6



170-65101 / 170-65201 / 170-65302 / 170-65401 / 170-65402 / 170-65404 / 170-65501 / 170-65601 / 170-65701 / 170-65901 / 170-65904

**Montage**

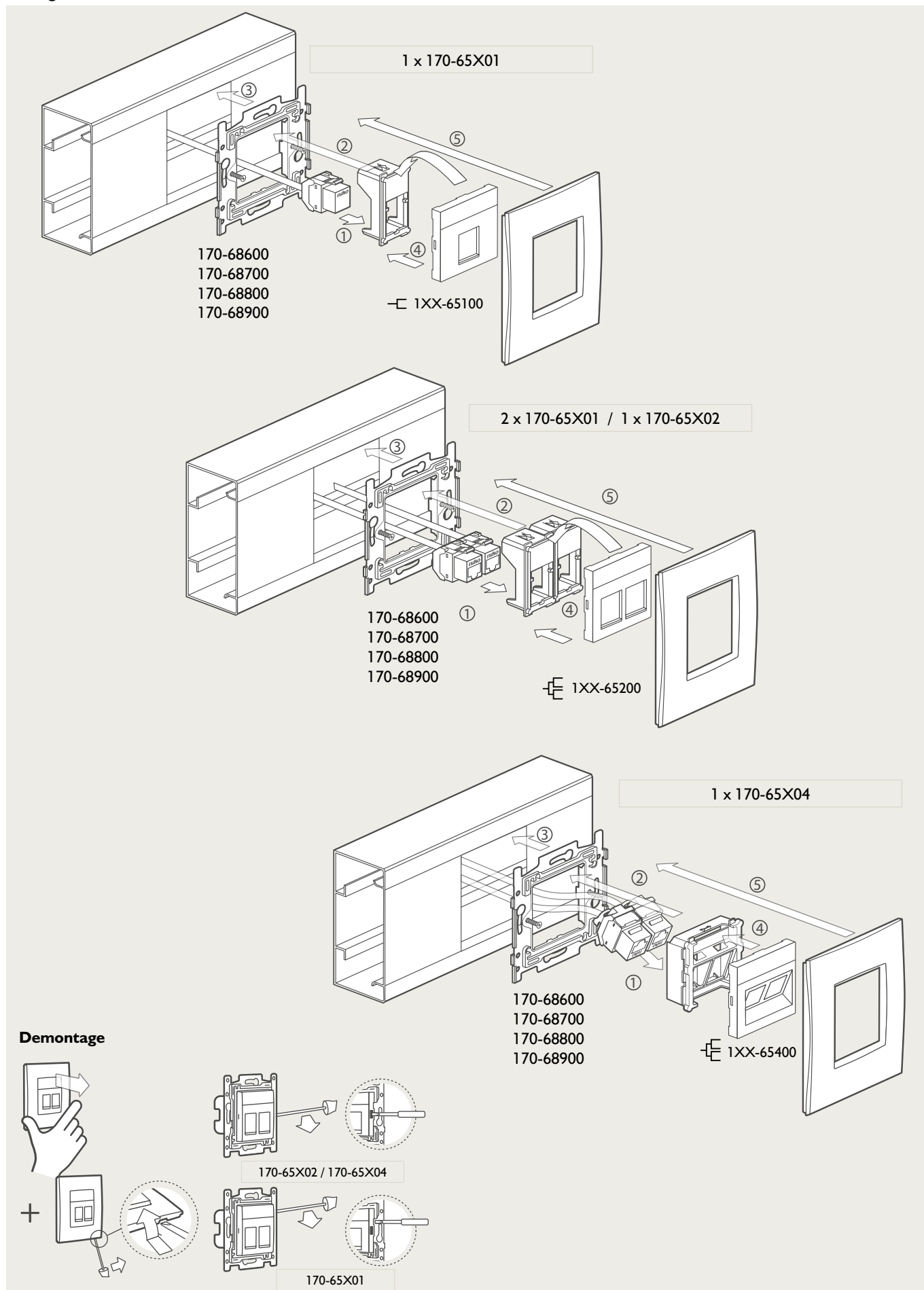

**Connector RJ45 UTP 650-45051 / 650-45061**

**Montage**

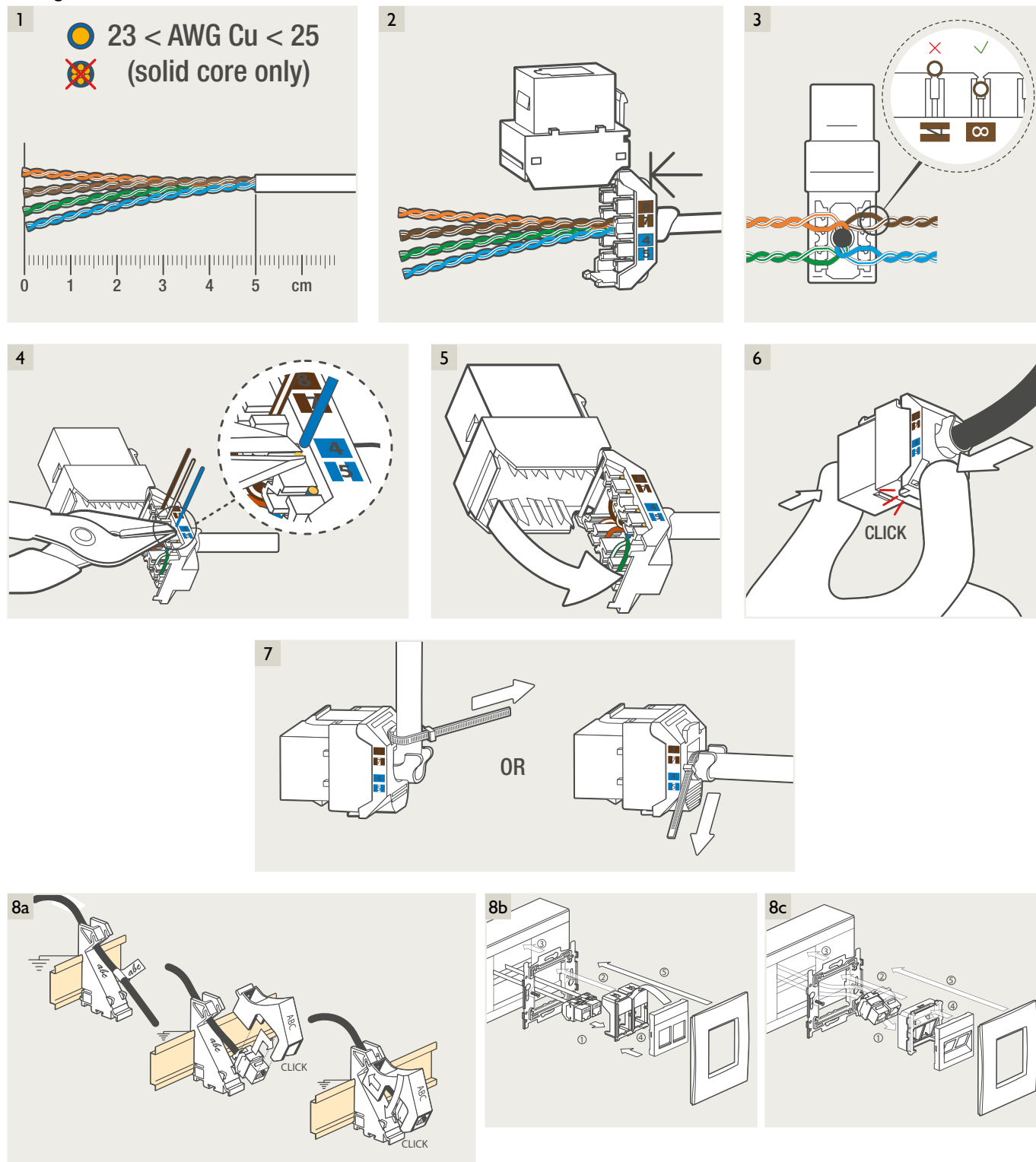

- D.1
- D.2
- D.3
- D.4
- D.5
- D.6

**Demontage**

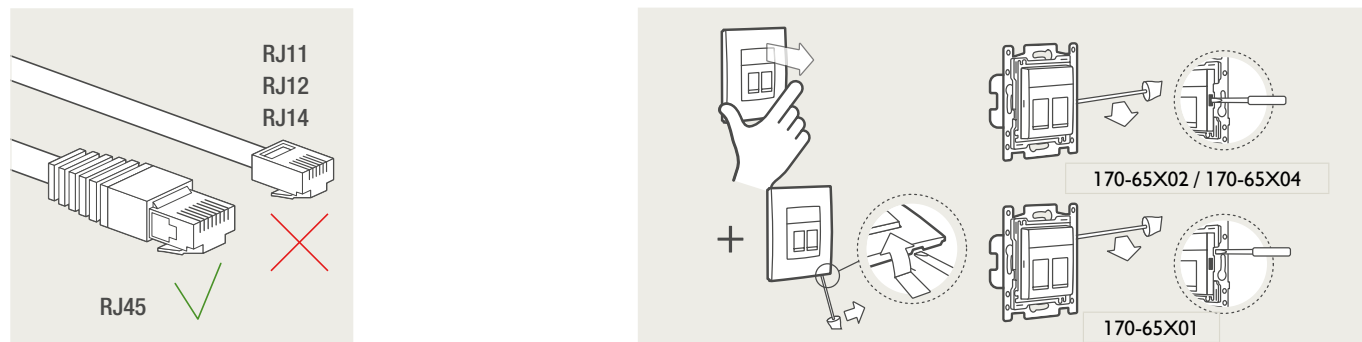

**Connector RJ45 STP 650-45055 / 650-45066**

**Montage**

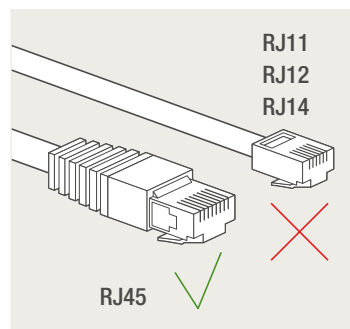
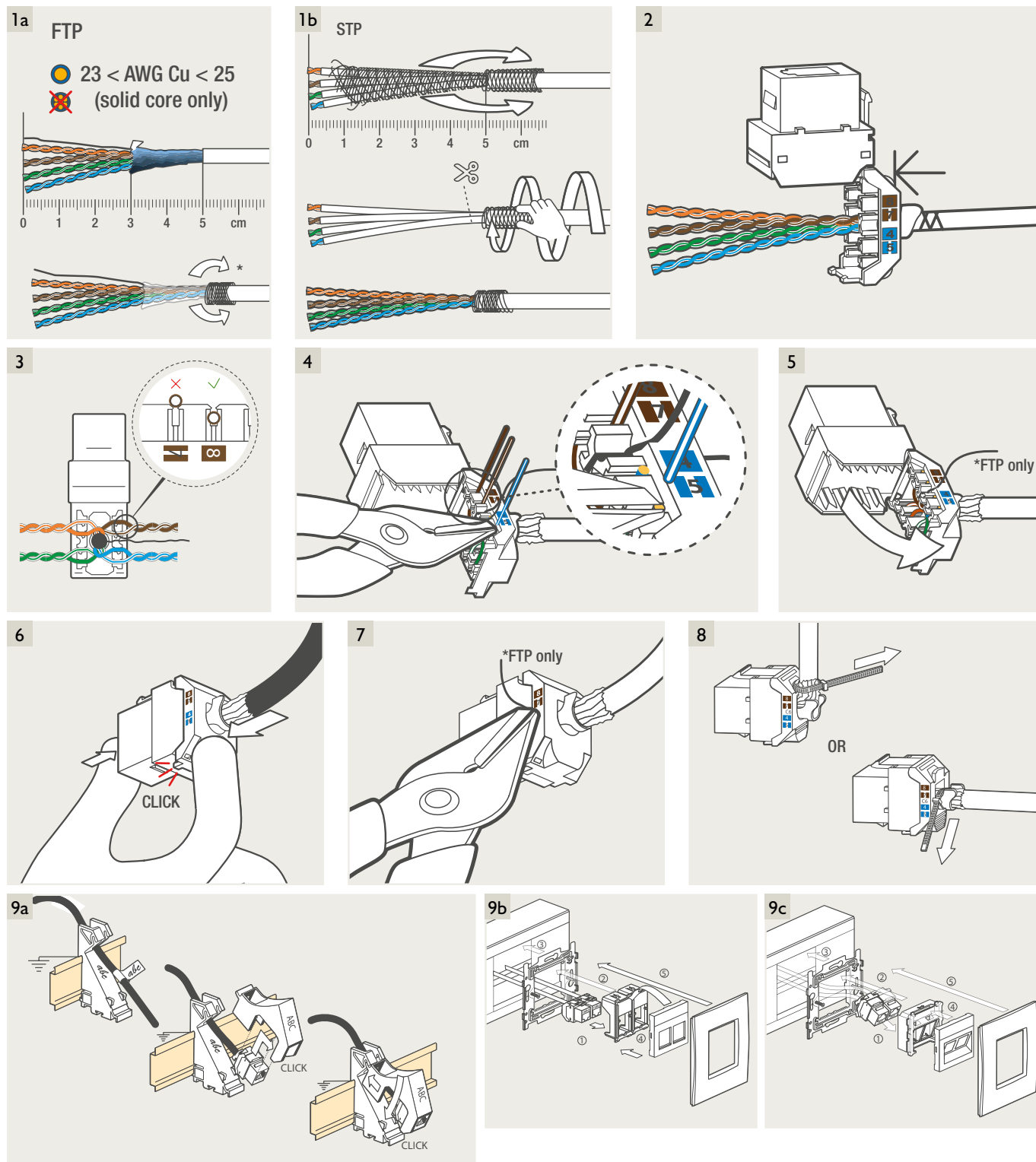

**Demontage**

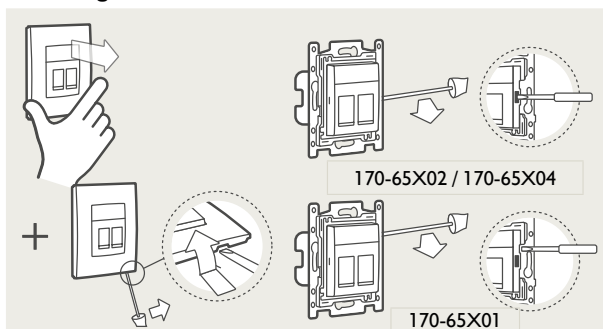

### Connector RJ11 650-45013

#### Montage

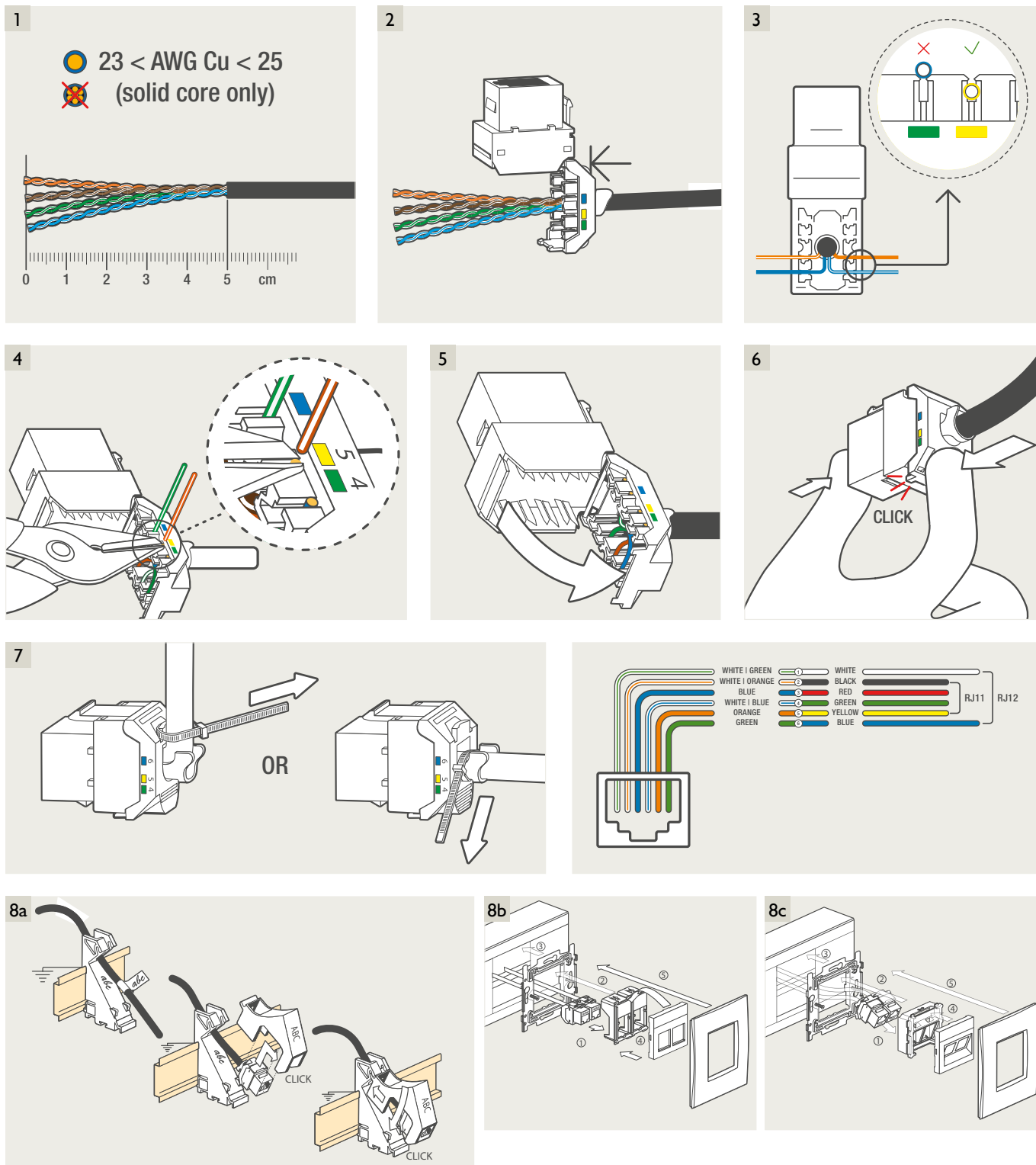

D.1  
 D.2  
 D.3  
 D.4  
 D.5  
 D.6

#### Demontage

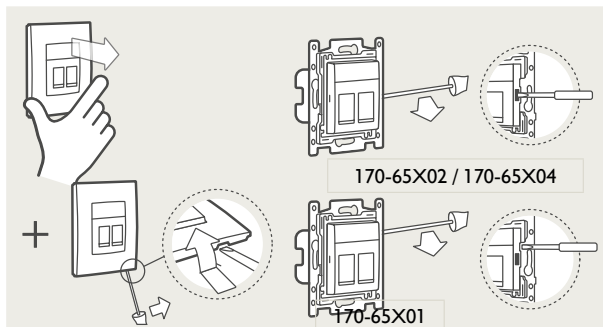

**DIN-rail connectoren 650-145XX / 650-111XX / 650-169XX**

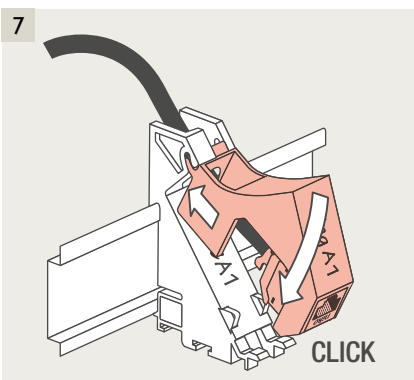
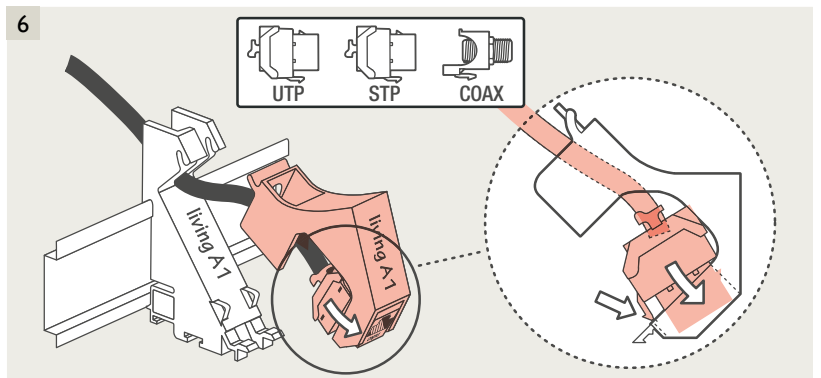
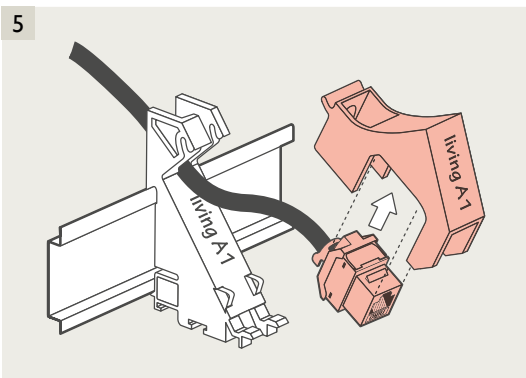
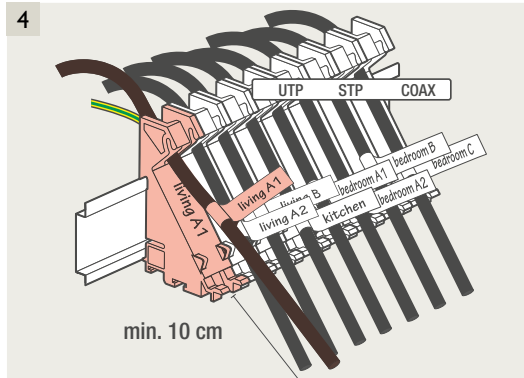
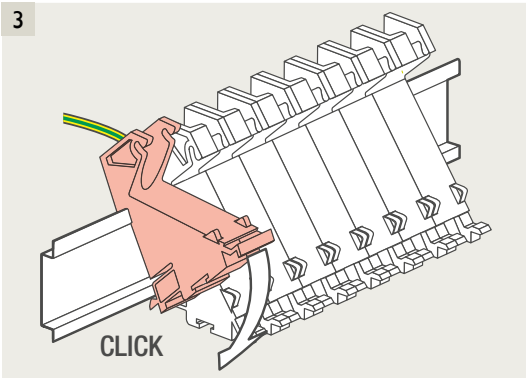
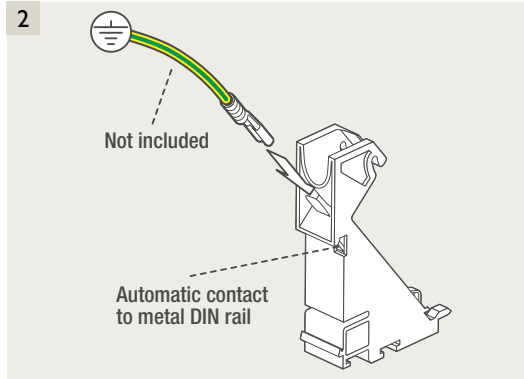
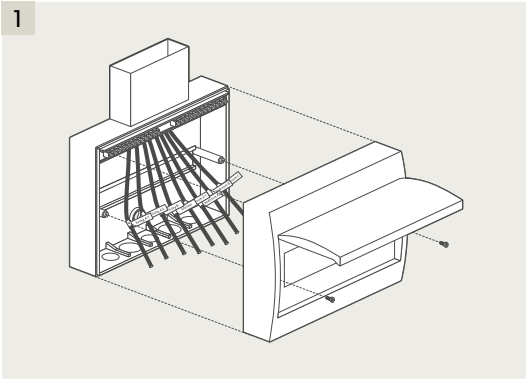

**Demontage**

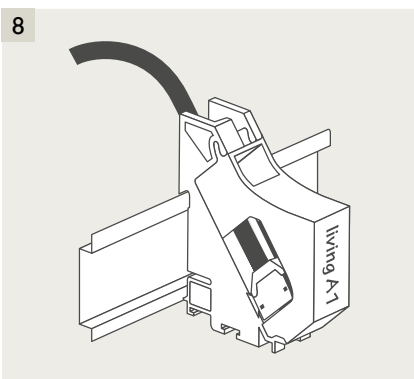
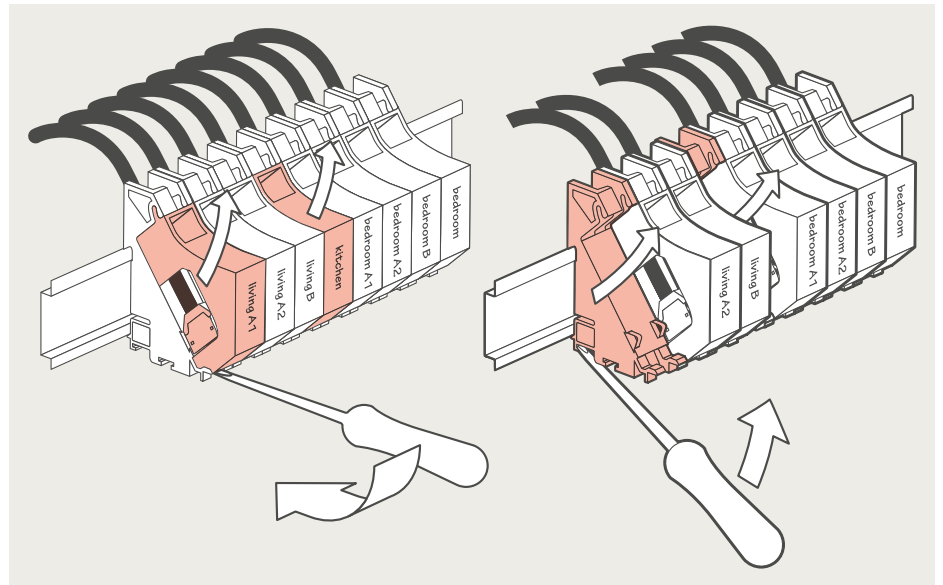

**D.3 Niko opbouwkit**

100-80100 / 101-80100 / 100-80200 / 101-80200

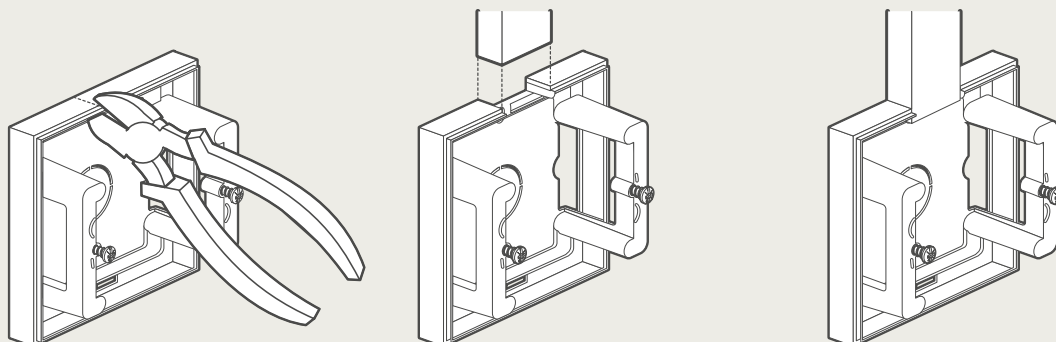
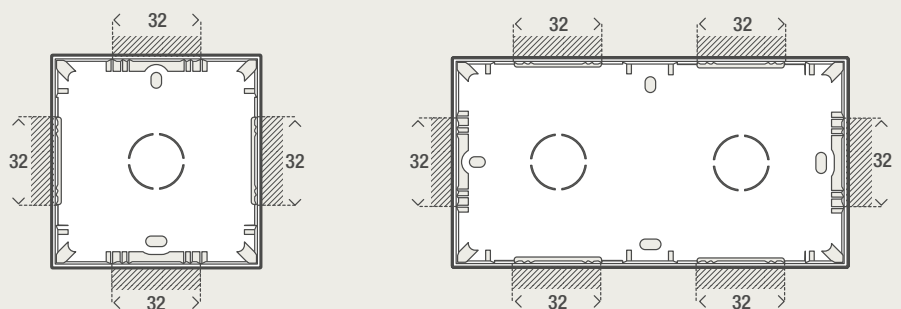
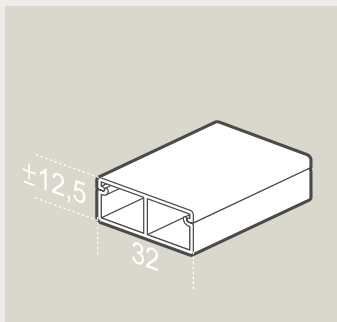
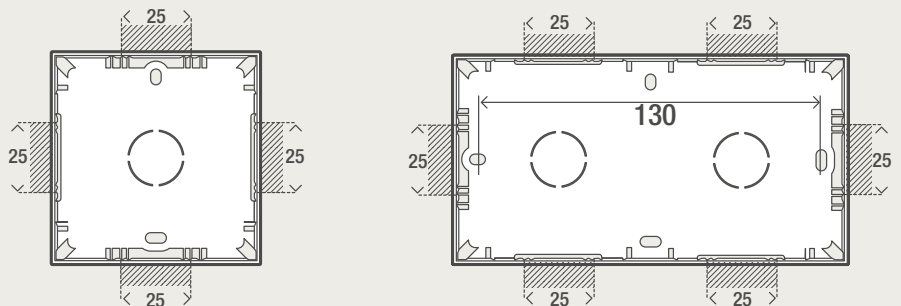
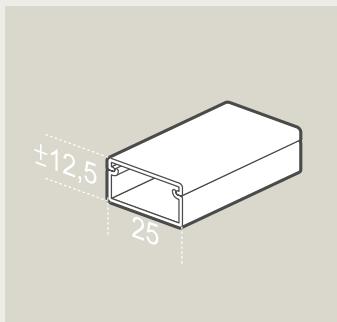
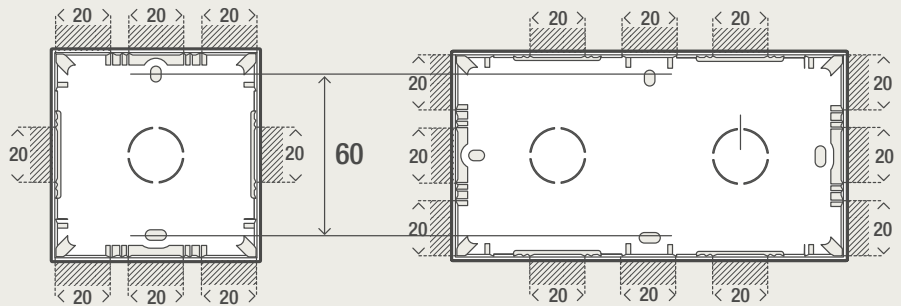
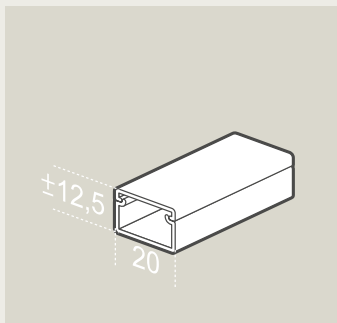
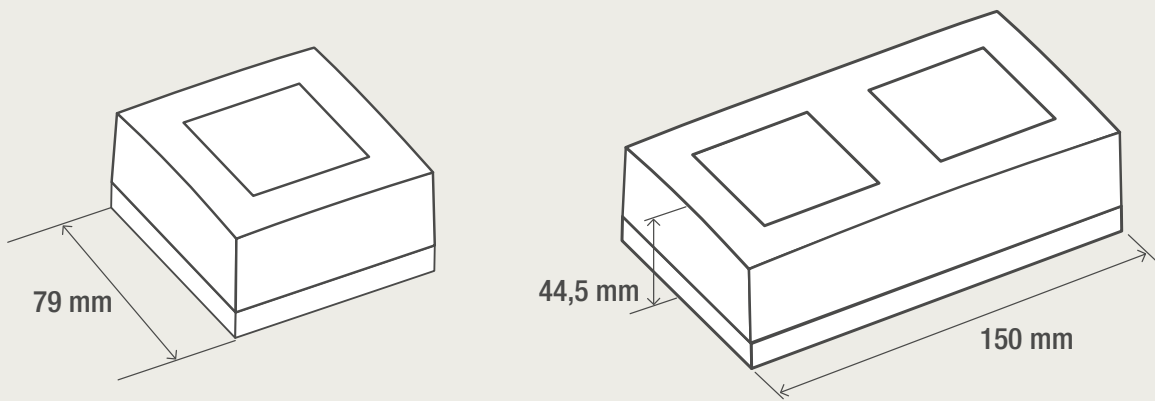

- D.1
- D.2
- D.3
- D.4
- D.5
- D.6**



**100-80100 / 101-80100 / 100-80200 / 101-80200**

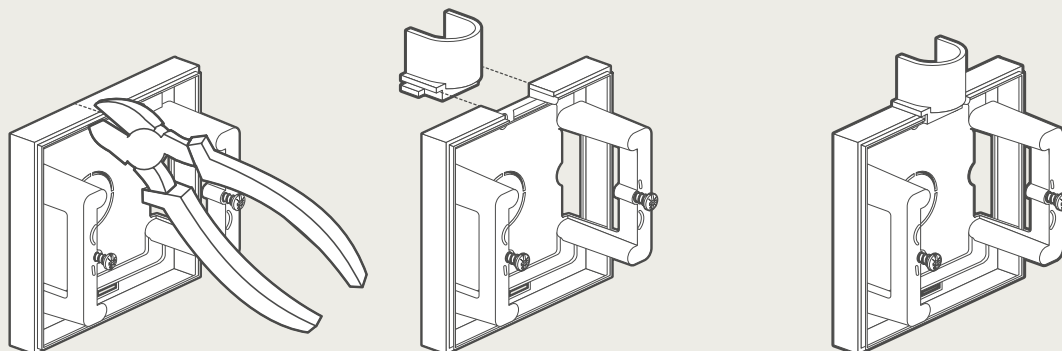
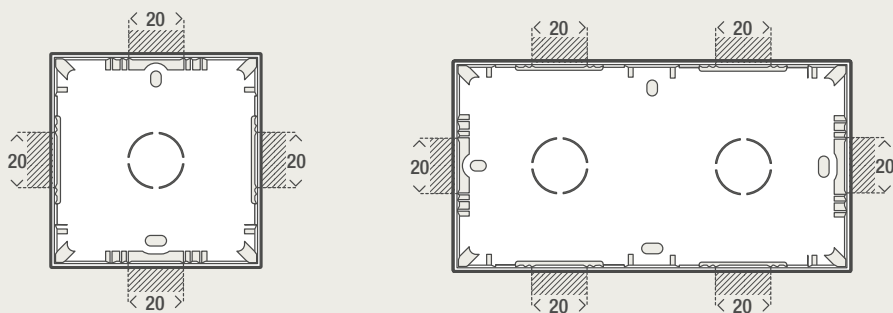
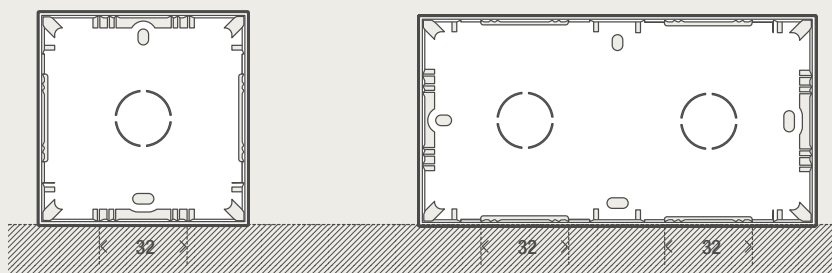
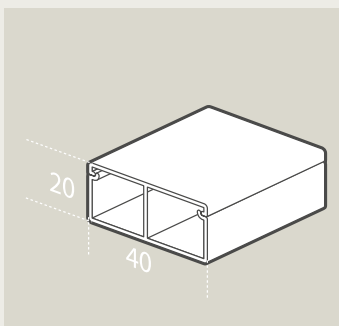
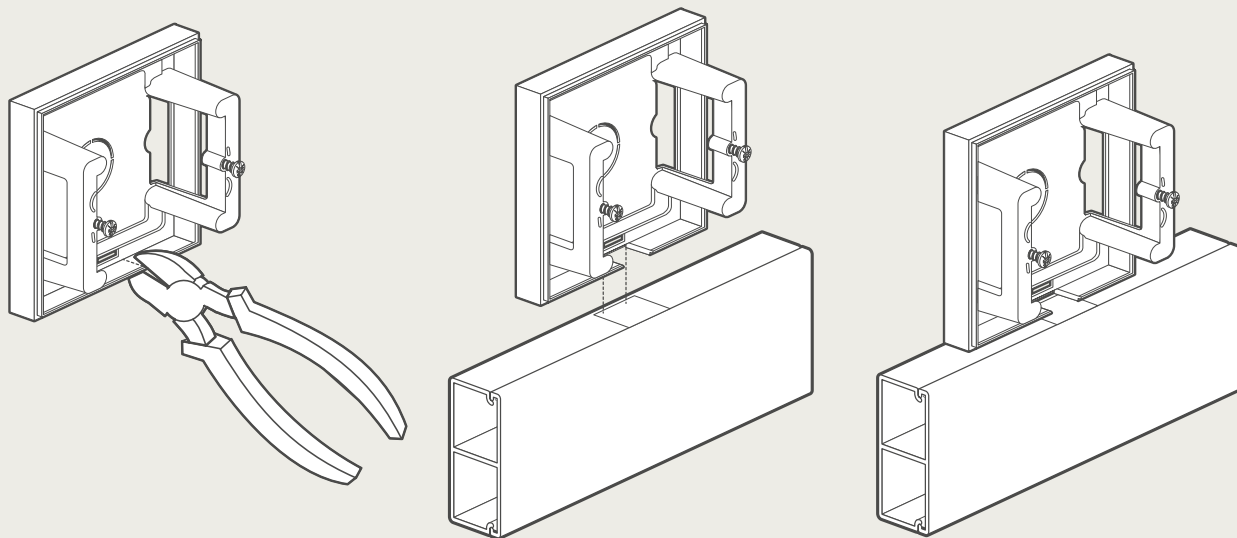

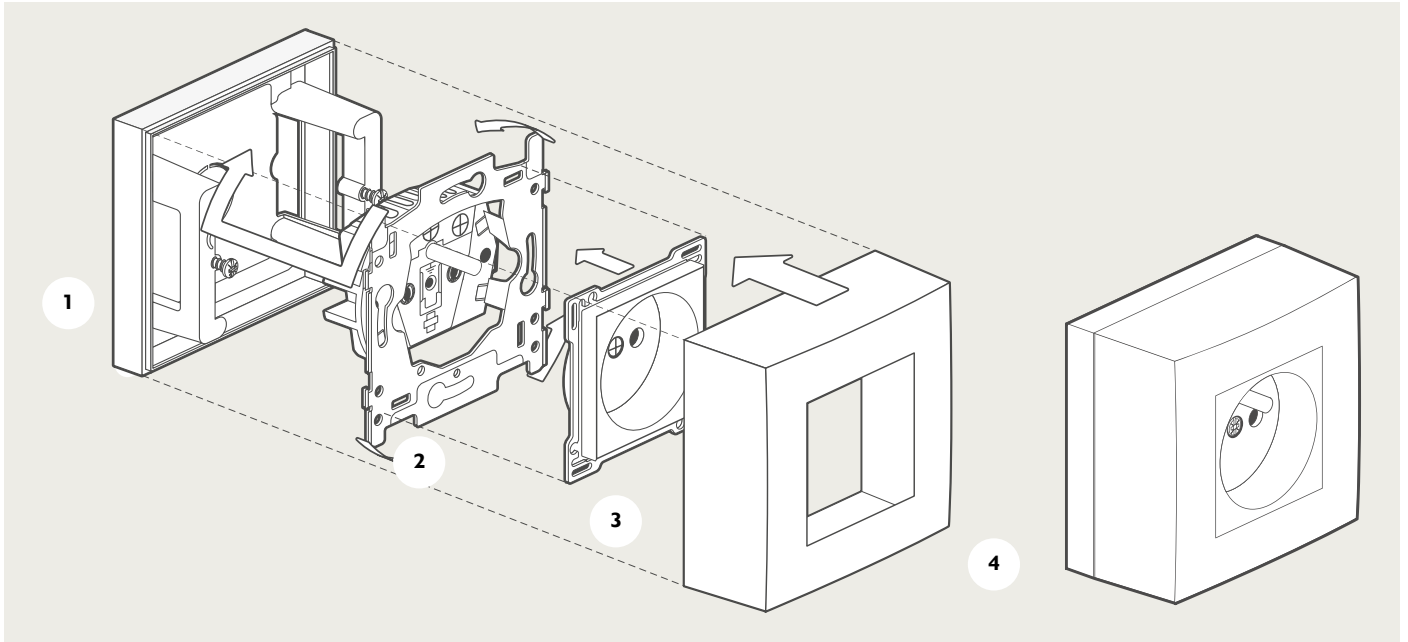
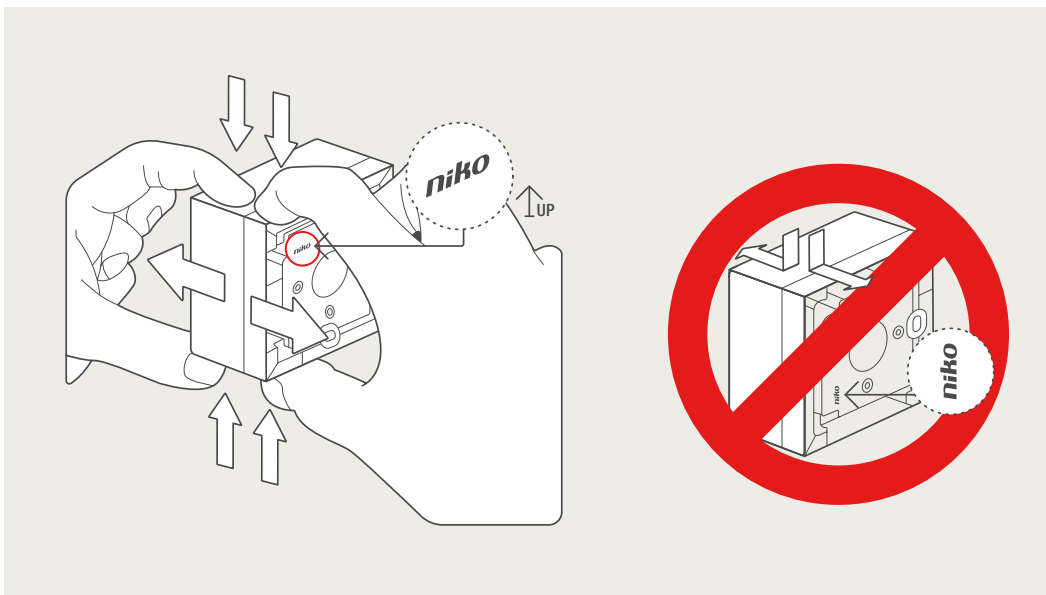

**Snelle en eenvoudige plaatsing in vier stappen****Demontage**

D.1

D.2

D.3

D.4

D.5

D.6



## D.4 Niko Hydro

### bevestigen en installeren

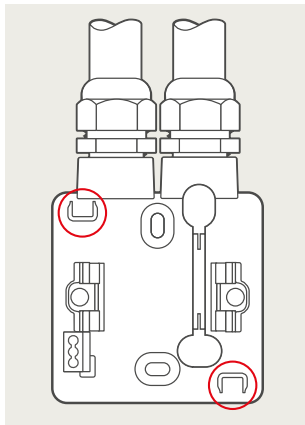

#### Condensatieopeningen

Door één van beide condensatieopeningen (volgens norm EN60669-1; NBN61-112-1) uit te breken, wordt de onderkant van de doos bepaald. De doos kan immers in twee richtingen gemonteerd worden en de opening hoort steeds onderaan te zitten.

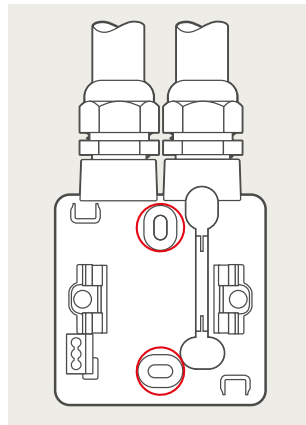

#### Bevestigingsopeningen

De bevestigingsopeningen bevinden zich op een verticale as. Elke schroefopening is ovaal en laat toe een onnauwkeurige boring op te vangen. De hartafstand tussen de bevestigingsopeningen is onuitwisbaar vermeld op de bodem van elke doos. Er is voldoende ruimte voorzien voor een elektrische schroevendraaier. Plaats het afdichtingslepelje over de schroeven om de dubbele isolatie en de beschermingsgraad IP55 te waarborgen.

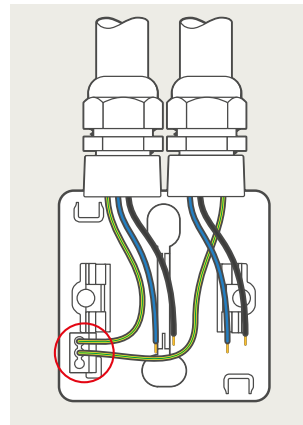

#### Aardingsklem

Breng de kabel in de doos en draai de wartel aan. Bij dozen met meerdere ingangen moet de aarding doorverbonden worden in de daartoe voorziene Wago insteekklem. Denk aan voldoende draadlengte.

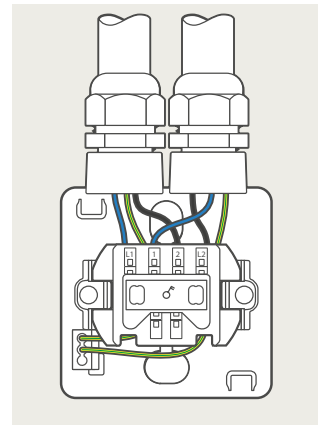

#### Sokkel

Eenmaal bedraad klikt u de sokkel op zijn plaats. Twee stevige houders grijpen de sokkel vast. De bedrading drukt het mechanisme dus niet naar buiten. Je hebt daardoor de handen vrij voor het monteren van het deksel. De sokkel kan eenvoudig worden verwijderd dmv een schroevendraaier.

## Niko Hydro - Inbouwkader (7XX-73000) voor het inbouwen van Niko Hydro functies in stenen muren

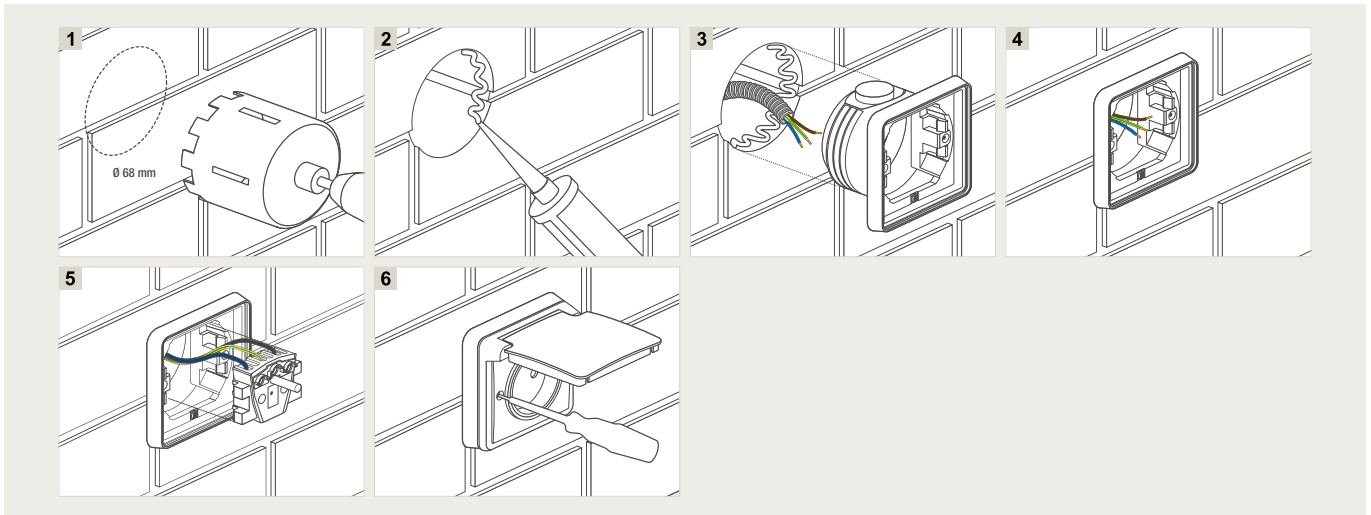

Je gebruikt het inbouwkader voor het waterdicht inbouwen van Niko Hydro functies. Het geheel garandeert een waterdichte afwerking.

Voor inbouw in gevelstenen of stenen muren:

1. Boor een gat met een diameter van 68 mm.
2. Breng een chemisch anker aan. (2-componentenlijm 2-K MIX 7)
3. Breng de bedrading binnen in de doos en veranker deze laatste in de muur.
- 4/5/6. Sluit de functie aan en werk verder af.

### Demontage - Optie 1

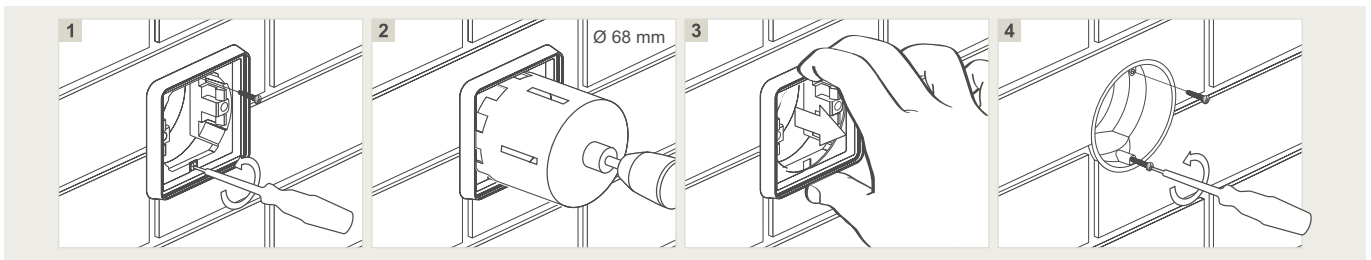

### Demontage - Optie 2

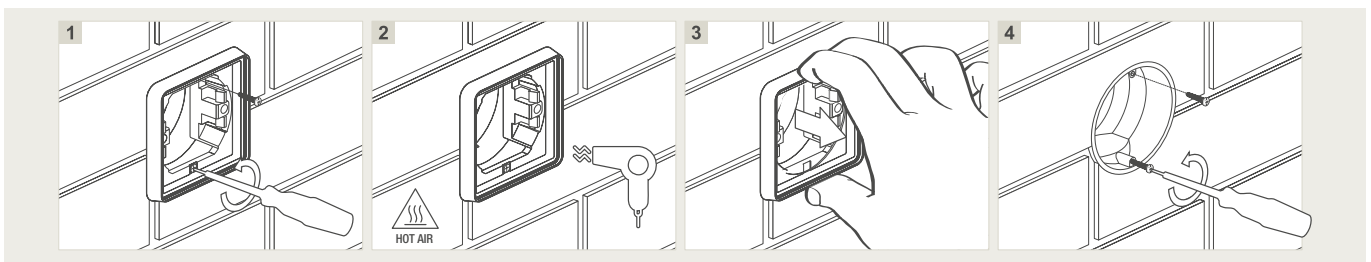

## Niko Hydro - Inbouwkader (7XX-73000) voor het inbouwen van Niko Hydro functies in panelen

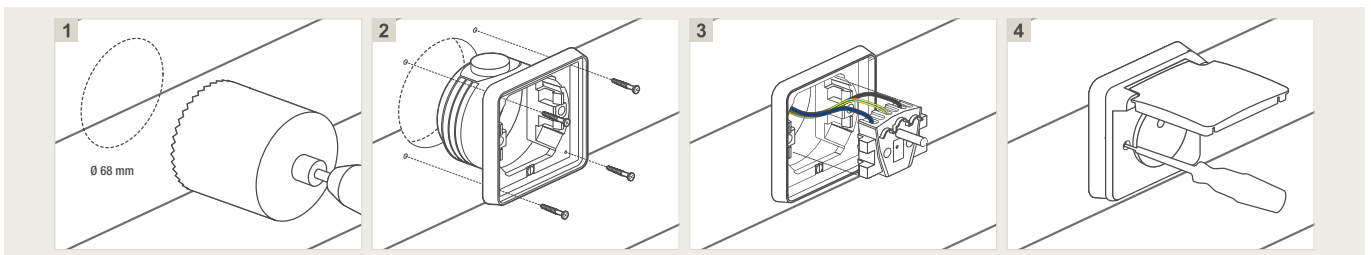

Voor inbouw in panelen:

1. Boor een gat met een diameter van 68 mm.
2. Breng de bedrading binnen in de doos en schroef het inbouwkader vast in de daartoe voorziene schroefgaten.
- 3/4. Sluit de functie aan en werk verder af.



De meest recente informatie vind je op [www.niko.eu](http://www.niko.eu)

D.1

D.2

D.3

D.4

D.5

D.6

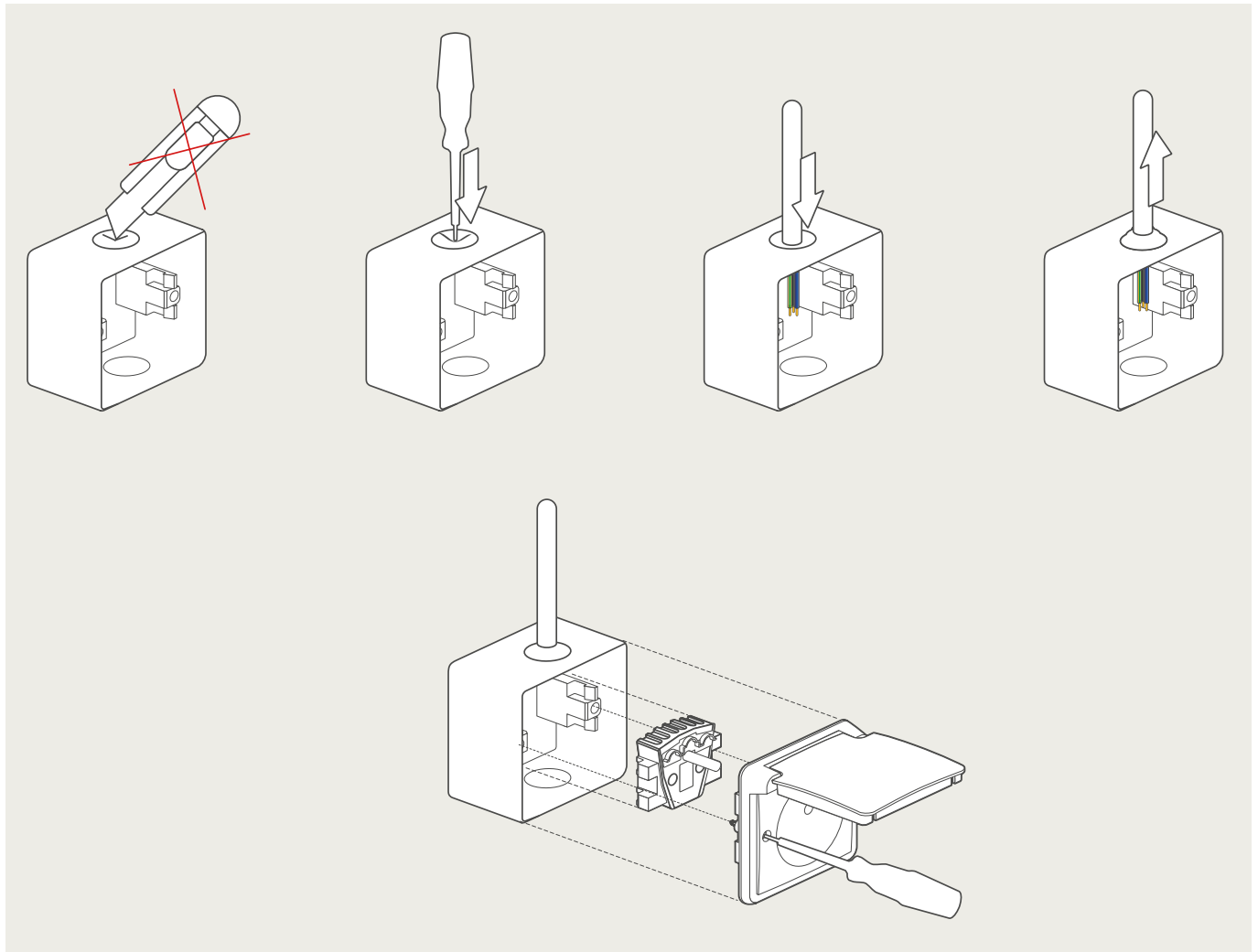
**Niko Hydro - opbouwdozen met soepele ingang (7XX-83101 en 7XX-83201)**

## Chemische bestendigheid (bij 23 °C)

|                          | ABS* | PP** |
|--------------------------|------|------|
| Aceton                   | -    | +/-  |
| Alkoholische drank       | +    | +    |
| Ammoniak (waterig)       | +    | +    |
| Benzine                  | +    | +/-  |
| Benzol                   | -    | -    |
| Dieselolie               | +    | +    |
| Azijazuur (sterk)        | +/-  | +    |
| Fluorkoolwaterstof       | -    | +/-  |
| Vruchtensappen           | +    | +    |
| Vaatwasmiddelen          |      | +    |
| Kaliloog (sterk)         | +    | +    |
| Methanol                 | +/-  | +    |
| Melk                     | +    | +    |
| Motorolie                | +    | +    |
| Natronloog (geconcentr.) | +    | +    |
| Ozon                     | +    | +/-  |
| Zoutzuur tot 35%         | +/-  | +    |
| Zwavelzuur tot 40%       | +    | +    |
| Zeepoplossing (waterig)  | +    | +    |
| Silikonolie              | +    | +    |
| Spijsolie - vet          | +    | +    |
| Tolueen                  | -    | -    |
| Trichloorethyleen (tri)  | -    | -    |
| Wasmiddelen              | +    | +    |
| Water en zeewater (koud) | +    | +    |
| Water (heet)             | +    | +    |

+ bestendig

+/- beperkt bestendig

- niet bestendig

\* = acrylonitril butadien styreen

\*\* = polypropyleen

D.1

D.2

D.3

D.4

D.5

D.6



De meest recente informatie  
vind je op [www.niko.eu](http://www.niko.eu)

**Niko Hydro - Maatschetsen**

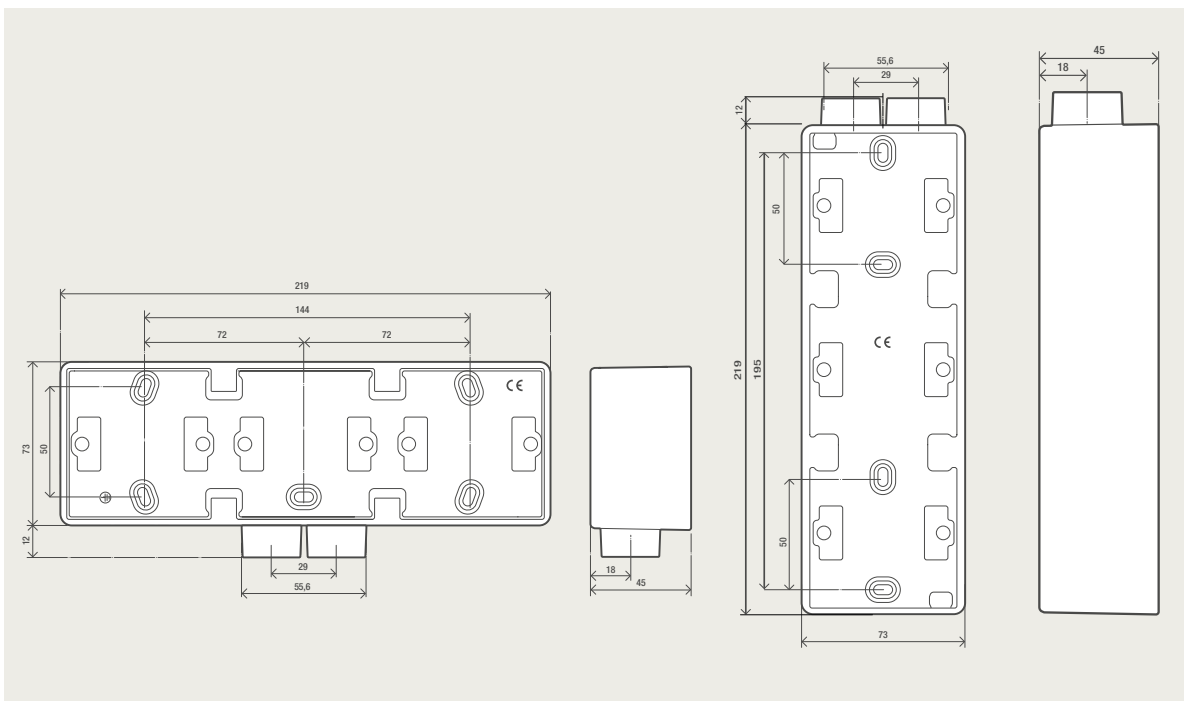
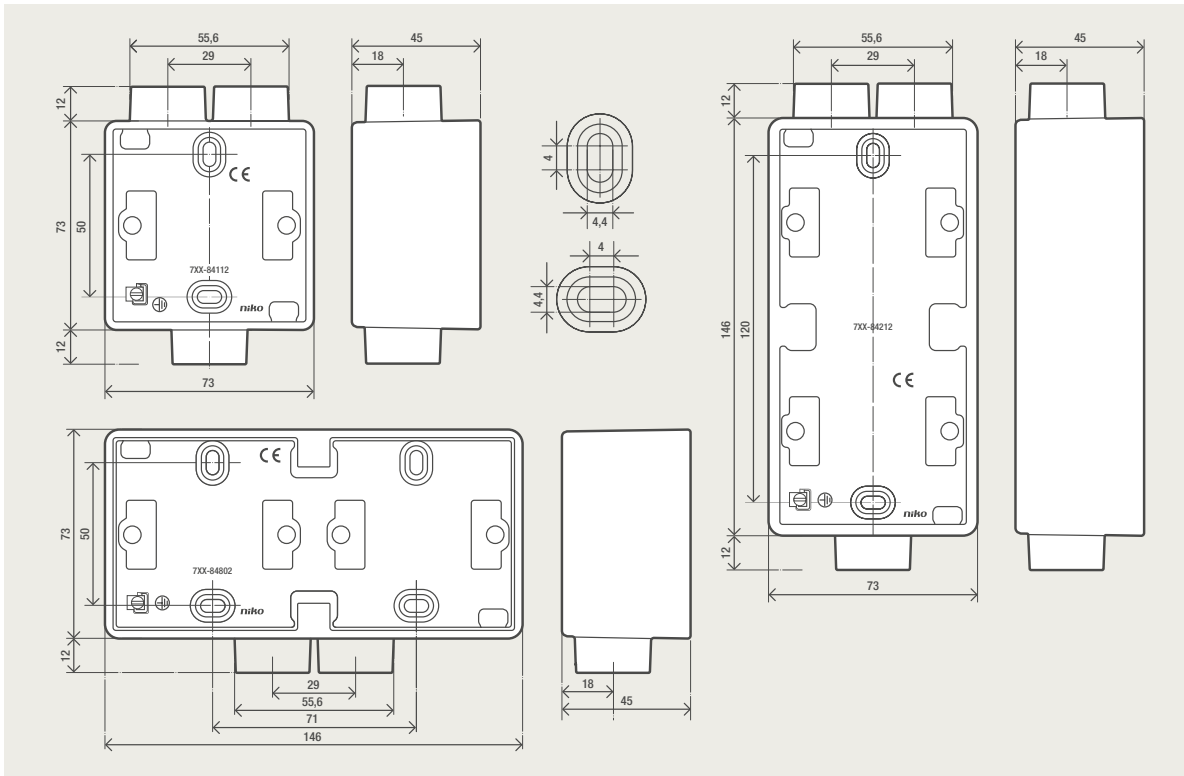

## Niko Hydro inbouwkader - Maatschetsen

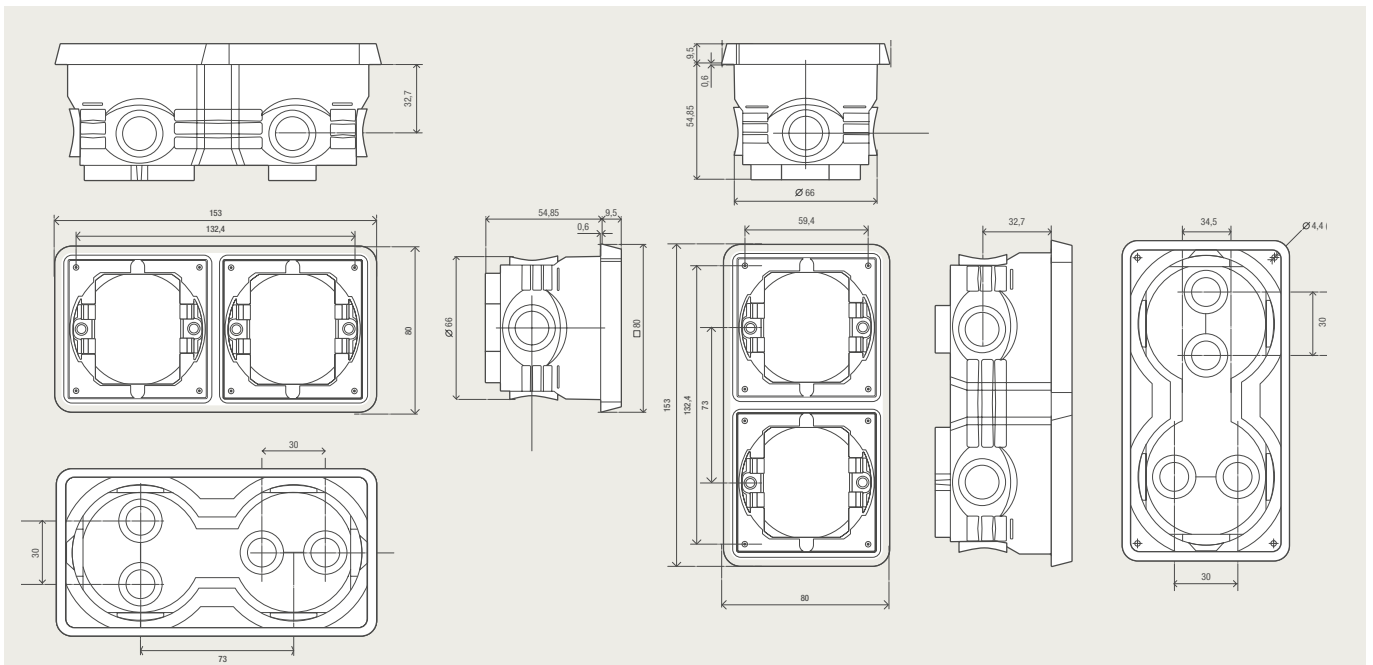
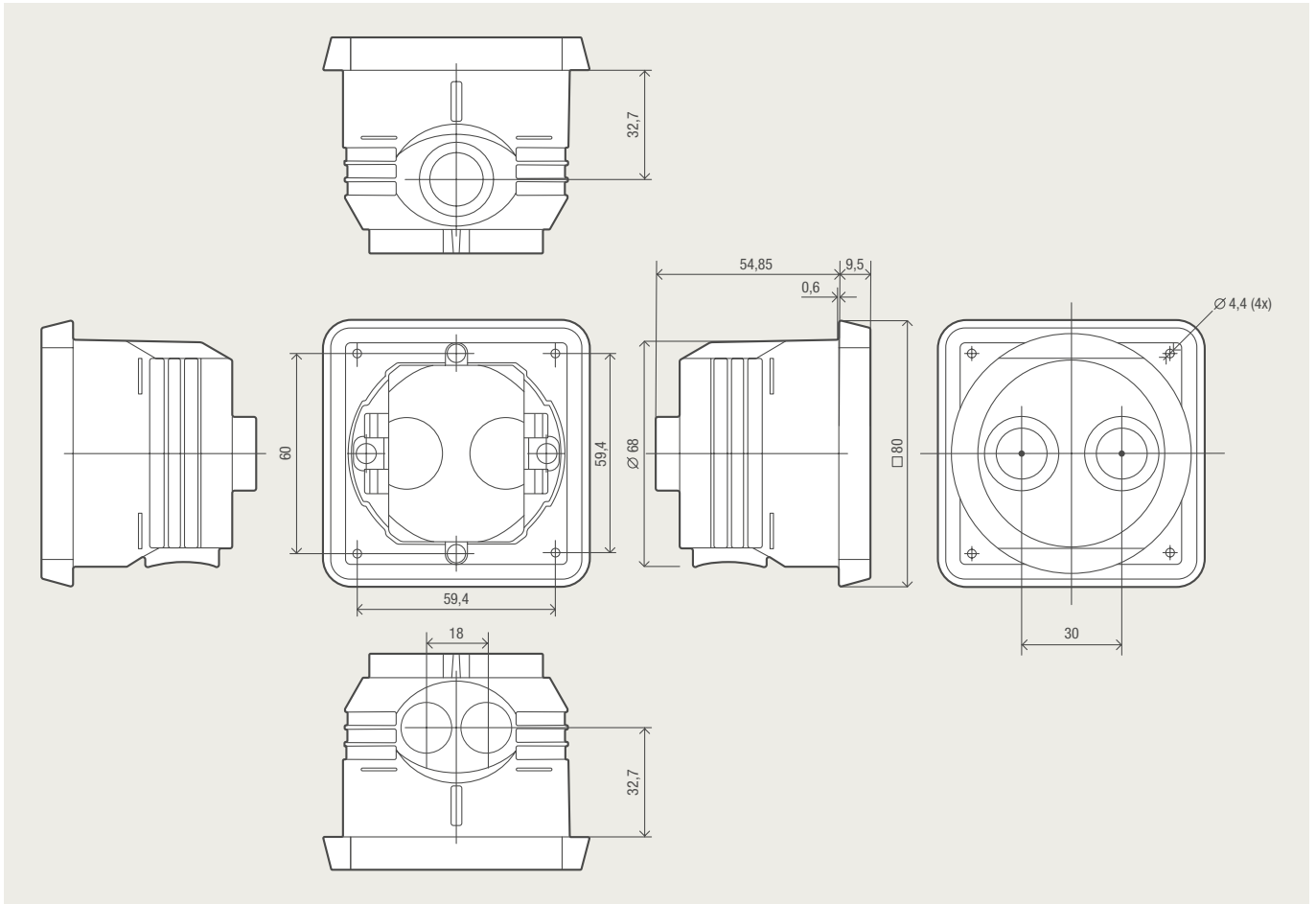

D.1

D.2

D.3

D.4

D.5

D.6



**D.5 Installatiekanalen**

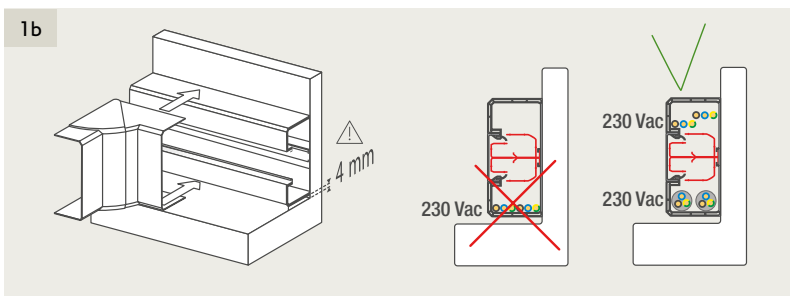
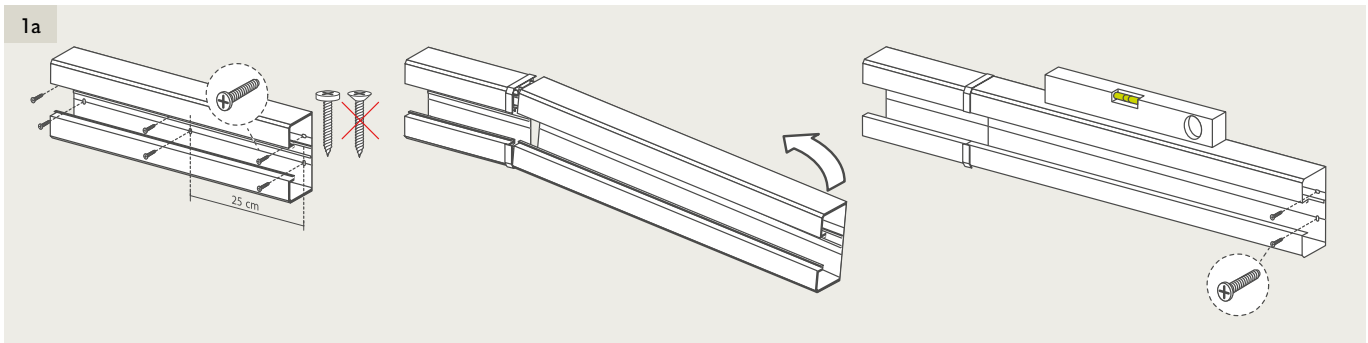
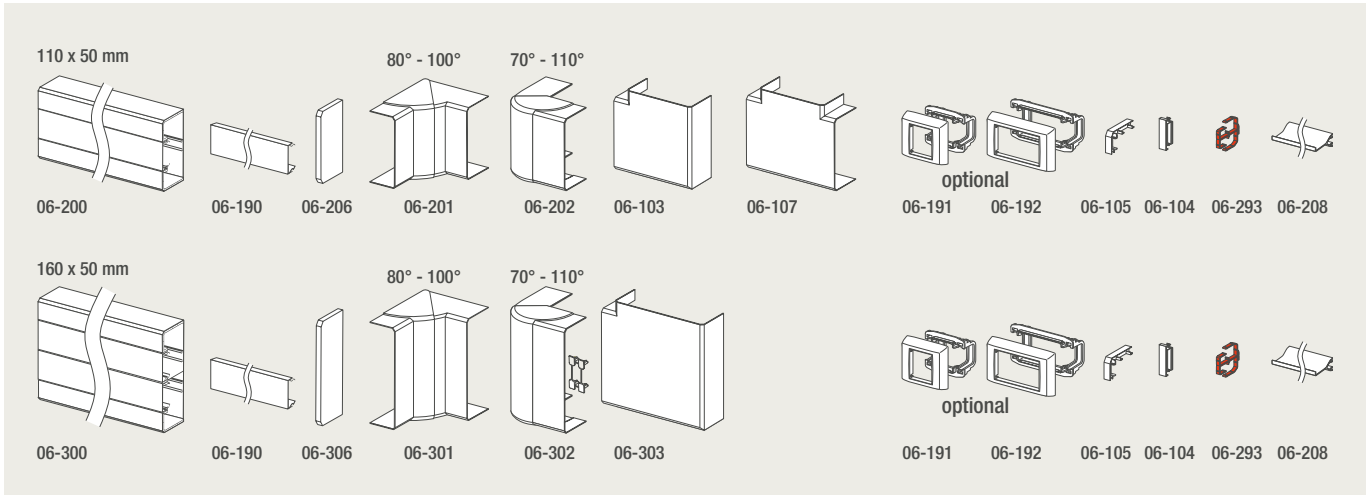
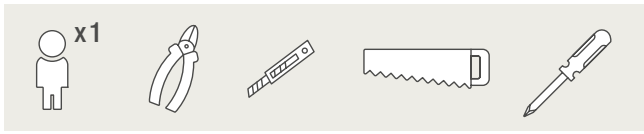



2

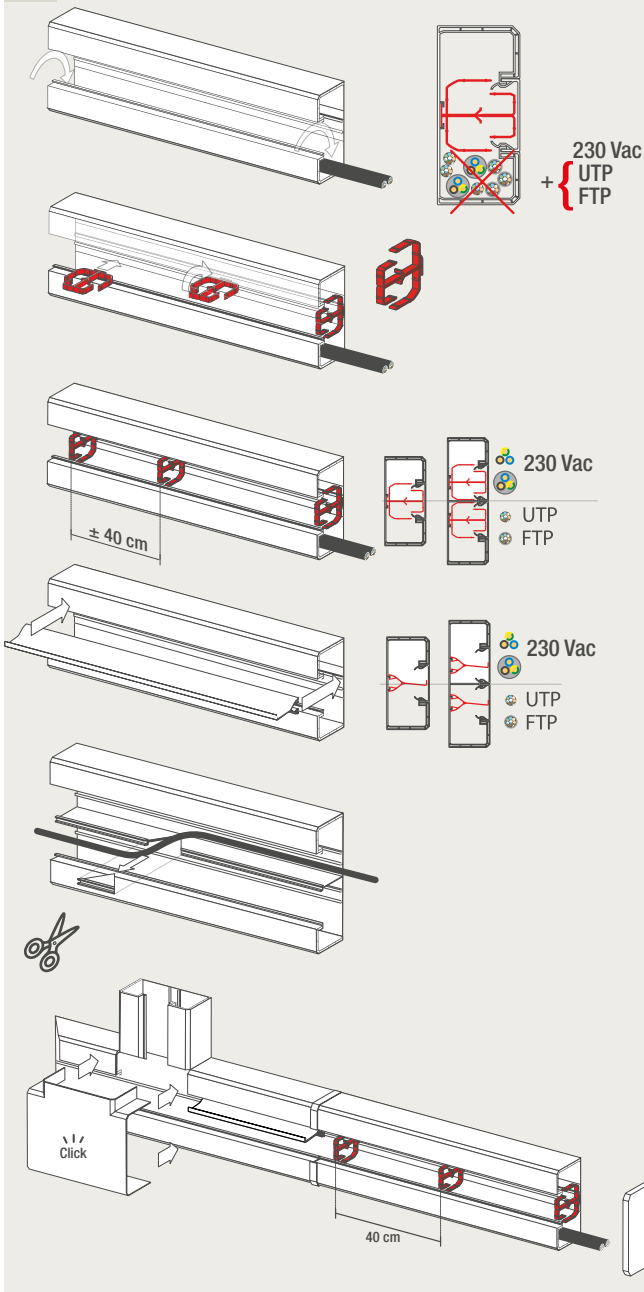

|                                    |        | 110 x 50 mm          | 160 x 50 mm          |
|------------------------------------|--------|----------------------|----------------------|
| 230 Vac<br>3 x 2,5 mm <sup>2</sup> | ZONE 1 | 7                    | 7                    |
|                                    | ZONE 2 | 4                    | 4                    |
| UTP<br>ø 6 mm                      | ZONE 1 | 21                   | 24                   |
|                                    | ZONE 2 | 12                   | 14                   |
| FTP<br>ø 8 mm                      | ZONE 1 | 15                   | 16                   |
|                                    | ZONE 2 | 8                    | 7                    |
| ZONE 1                             |        | 1250 mm <sup>2</sup> | 1250 mm <sup>2</sup> |
| ZONE 2                             |        | 662 mm <sup>2</sup>  | 662 mm <sup>2</sup>  |

3

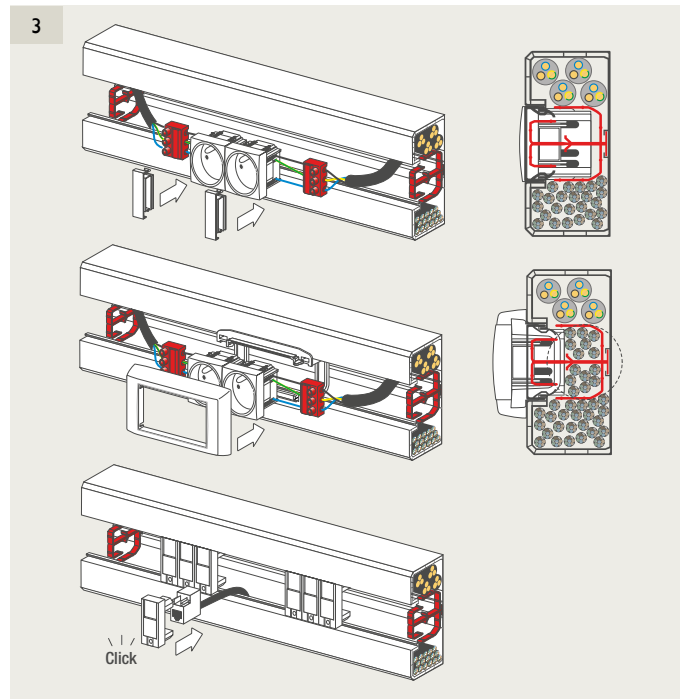

4

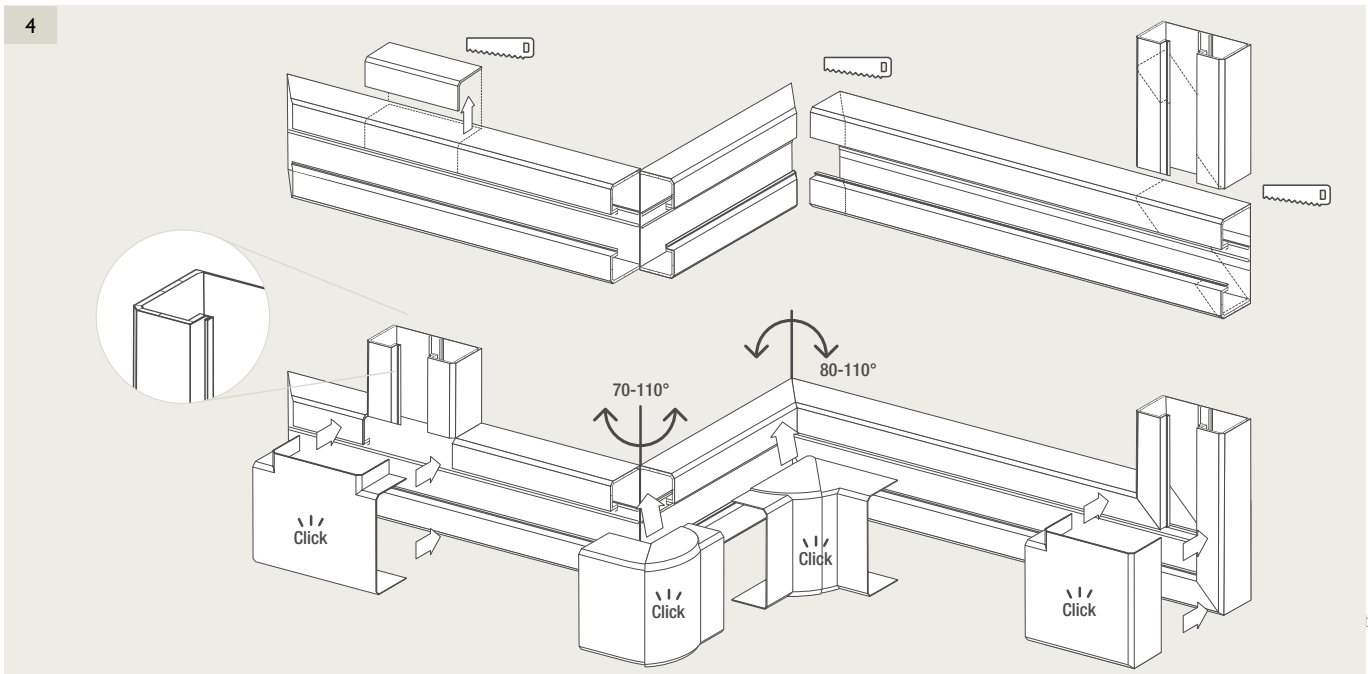

D.1  
D.2  
D.3  
D.4  
D.5  
D.6

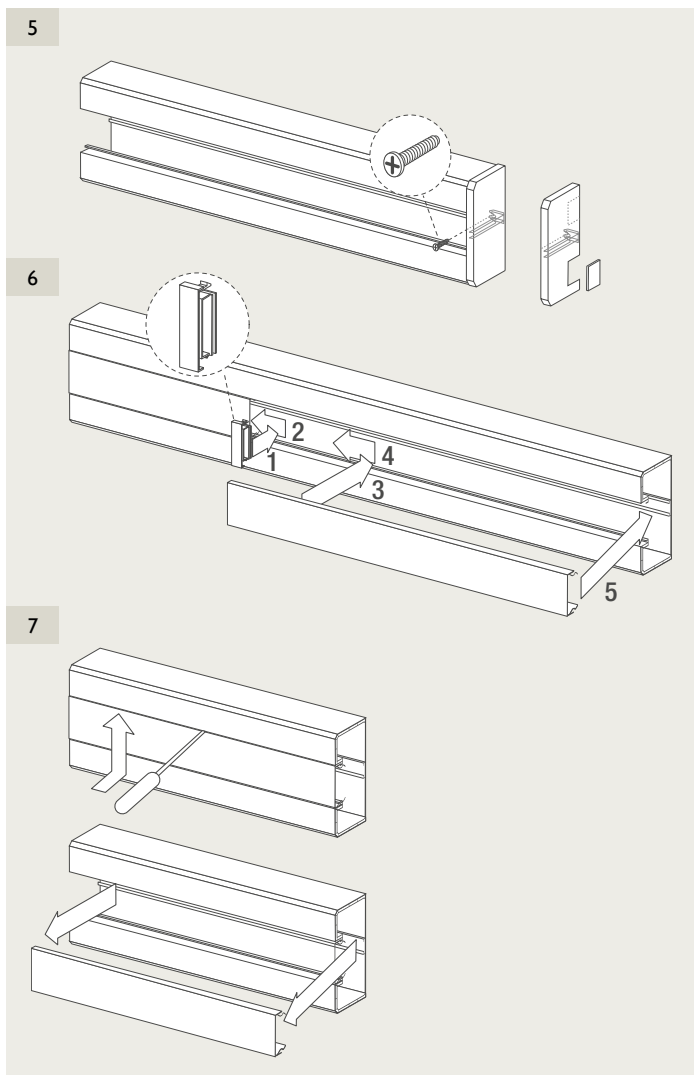
**Technische kenmerken installatiekanalen**

- Materiaal: PVC
- Slagsterkte: voldoet aan IK07 (EN 50102)
- Isolatieweerstand:  $\geq 100 \text{ MW}$
- Gebruikstemperatuur: bij transport:  $-25 \text{ }^\circ\text{C}$  tot  $60 \text{ }^\circ\text{C}$   
bij installatie:  $-5 \text{ }^\circ\text{C}$  tot  $60 \text{ }^\circ\text{C}$
- IP40: bescherming tegen indringen van vaste stoffen  $\varnothing > 1 \text{ mm}$
- 230 Vac, 16 A
- Brandklasse M1 volgens NF P 92-501 en FD P 92-507

- D.1
- D.2
- D.3
- D.4
- D.5
- D.6**











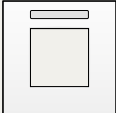

### Afdekplaten voor specifieke toepassingen

Afdekplaten met tekstveld voor gemakkelijke etikettering en identificatie. Bijzonder geschikt voor gebruik in de gezondheidszorg, detailhandels, kantoorgebouwen, ziekenhuizen ...

#### Afdekplaten voor een veilige en onverliesbare identificatie



|    | Referentie | Omschrijving                       | Centerafstand | Afm. afdekplaat | Opbouwhoogte | Verpakking |
|---|------------|------------------------------------|---------------|-----------------|--------------|------------|
|    | 120-76101  | enkelvoudige afdekplaat            | -             | 85 x 85 mm      | 8,5 mm       | 50 stuks   |
|    | 120-76801  | tweevoudige afdekplaat verticaal   | 71 mm         | 156 x 85 mm     | 8,5 mm       | 25 stuks   |
|    | 120-76802  | tweevoudige afdekplaat horizontaal | 71 mm         | 156 x 85 mm     | 8,5 mm       | 25 stuks   |
|    | 120-76701  | drievoudige afdekplaat verticaal   | 71 mm         | 227 x 85 mm     | 8,5 mm       | 20 stuks   |
|   | 120-76702  | drievoudige afdekplaat horizontaal | 71 mm         | 227 x 85 mm     | 8,5 mm       | 20 stuks   |
|  | 120-76401  | viervoudige afdekplaat verticaal   | 71 mm         | 298 x 85 mm     | 8,5 mm       | 5 stuks    |
|  | 120-76402  | viervoudige afdekplaat horizontaal | 71 mm         | 298 x 85 mm     | 8,5 mm       | 5 stuks    |





#### Afzonderlijk te bestellen accessoires:

- labeldrager 170-00090
- labelpapier 170-00091

#### Afdekplaten voor gebruik in installatiekanalen





Speciaal ontworpen voor gebruik in installatiekanalen met een dekselopening van 80mm

|  | Referentie | Omschrijving                       | Centerafstand | Afm. afdekplaat | Opbouwhoogte | Verpakking |
|---|------------|------------------------------------|---------------|-----------------|--------------|------------|
|  | 101-76101  | enkelvoudige afdekplaat            | -             | 80 x 80 mm      | 9,5 mm       | 50 stuks   |
|  | 101-76801  | tweevoudige afdekplaat horizontaal | 71 mm         | 80 x 150 mm     | 9,5 mm       | 25 stuks   |







| Afdekplaten   |   |   |   |   | Afwerkingsset |              |
|---|---|---|---|---|---------------|--------------|
| Centerafstand 71 mm horizontaal/verticaal   |   |   |   |   |               |              |
|  |  |  |  |  | Ref. code     | Omschrijving |
| 8,3 x<br>8,3 cm   | 8,3 x<br>15,4 cm  | 8,3 x<br>22,5 cm  | 8,3 x<br>29,6 cm  | 8,3 x<br>36,7 cm  |               |              |

| Niko Pure   |                                  |           |           |           |           |           |           |                                   |
|---|----------------------------------|-----------|-----------|-----------|-----------|-----------|-----------|-----------------------------------|
|    | liquid snow white                | 241-76100 | 241-76800 | 241-76700 | 241-76400 | 241-76005 | 101-xxxxx | white                             |
|    | white steel                      | 154-76100 | 154-76800 | 154-76700 | 154-76400 | 154-76005 | 154-xxxxx | white coated                      |
|    | stainless steel<br>on white      | 250-76100 | 250-76800 | 250-76700 | 250-76400 | 250-76005 | 154-xxxxx | white coated                      |
|    | champagne steel                  | 157-76100 | 157-76800 | 157-76700 | 157-76400 | 157-76005 | 157-xxxxx | champagne coated                  |
|   | alu gold                         | 221-76100 | 221-76800 | 221-76700 | 221-76400 | 221-76005 | 221-xxxxx | gold coated                       |
|  | natural soft grey                | 159-76100 | 159-76800 | 159-76700 | /         | /         | 122-xxxxx | anthracite                        |
|  | alu grey                         | 155-76100 | 155-76800 | 155-76700 | 155-76400 | 155-76005 | 122-xxxxx | anthracite                        |
|  | stainless steel<br>on anthracite | 150-76100 | 150-76800 | 150-76700 | 150-76400 | 150-76005 | 122-xxxxx | anthracite                        |
|  | bamboo                           | 156-76100 | 156-76800 | 156-76700 | 156-76400 | 156-76005 | 122-xxxxx | anthracite                        |
|  | natural red                      | 152-76100 | 152-76800 | 152-76700 | /         | /         | 122-xxxxx | anthracite                        |
|  | alu steel grey                   | 220-76100 | 220-76800 | 220-76700 | 220-76400 | 220-76005 | 220-xxxxx | steel grey coated                 |
|  | alu black                        | 158-76100 | 158-76800 | 158-76700 | 158-76400 | 158-76005 | 154-xxxxx | white coated                      |
|  | black steel                      | 161-76100 | 161-76800 | 161-76700 | 161-76400 | 161-76005 | 161-xxxxx | black coated                      |
|  | liquid black                     | 242-76100 | 242-76800 | 242-76700 | 242-76400 | 242-76005 | 200-xxxxx | Bakelite®-look piano black coated |
|  | Bakelite® piano black            | 200-76100 | 200-76800 | 200-76700 | /         | /         | 200-xxxxx | Bakelite®-look piano black coated |
|  | dark bamboo<br>on gold           | 257-76100 | 257-76800 | 257-76700 | 257-76400 | 257-76005 | 221-xxxxx | gold coated                       |
|  | dark bamboo<br>on anthracite     | 256-76100 | 256-76800 | 256-76700 | 256-76400 | 256-76005 | 122-xxxxx | anthracite                        |
| <b>Verpakking (stuks)</b>   |                                  | 10        | 5         | 1         | 1         | 1         |           |                                   |





Bakelite® is a registered trademark of Hexion GmbH

|   |   |   |   |   |               |              |
|---|---|---|---|---|---------------|--------------|
|   |   |   |   |   | Afwerkingsset |              |
| Centerafstand <b>71 mm</b> horizontaal/verticaal                                  |   |   |   |   |               |              |
|  |  |  |  |  | Ref. code     | Omschrijving |

8,5 x 8,5 cm      8,5 x 15,6 cm      8,5 x 22,7 cm      8,5 x 29,8 cm      8,5 x 36,7 cm

| <b>Niko Intense</b>   |            |           |           |           |           |           |           |              |
|---|------------|-----------|-----------|-----------|-----------|-----------|-----------|--------------|
|    | white      | 120-76100 | 120-76800 | 120-76700 | 120-76400 | 120-76005 | 101-xxxxx | white        |
|    | sterling   | 121-76100 | 121-76800 | 121-76700 | 121-76400 | 121-76005 | 121-xxxxx | sterling     |
|    | bronze     | 123-76100 | 123-76800 | 123-76700 | 123-76400 | 123-76005 | 123-xxxxx | bronze       |
|    | dark brown | 124-76100 | 124-76800 | 124-76700 | 124-76400 | 124-76005 | 124-xxxxx | dark brown   |
|    | anthracite | 122-76100 | 122-76800 | 122-76700 | 122-76400 | 122-76005 | 122-xxxxx | anthracite   |
|  | matt black | 130-76100 | 130-76800 | 130-76700 | 130-76400 | 130-76005 | 161-xxxxx | black coated |
| <b>Verpakking (stuks)</b>   |            | 10        | 5         | 5         | 1         | 1         |           |              |

8,3 x 8,3 cm      8,3 x 15,4 cm      8,3 x 22,5 cm      8,3 x 29,6 cm      8,3 x 36,7 cm

| <b>Niko Original</b>  |              |           |           |           |           |           |           |              |
|---|--------------|-----------|-----------|-----------|-----------|-----------|-----------|--------------|
|  | bright white | 111-76100 | 111-76800 | 111-76700 | 111-76400 | 111-76005 | 111-xxxxx | bright white |
|  | white        | 101-76100 | 101-76800 | 101-76700 | 101-76400 | 101-76005 | 101-xxxxx | white        |
|  | cream        | 100-76100 | 100-76800 | 100-76700 | 100-76400 | 100-76005 | 100-xxxxx | cream        |
|  | light grey   | 102-76100 | 102-76800 | 102-76700 | 102-76400 | 102-76005 | 102-xxxxx | light grey   |
|  | greige*      | 104-76100 | 104-76800 | 104-76700 | 104-76400 | 104-76005 | 104-xxxxx | greige       |
| <b>Verpakking (stuks)</b>   |              | 50        | 25        | 20        | 5         | 5         |           |              |

\* Uitzondering: greige afdeklatten standaard verpakt per 5, de enkelvoudige per 10.

Niko ontwerpt elektr(on)ische oplossingen die gebouwen beter laten werken voor iedereen die erin leeft en werkt. Door minder energie te verbruiken, lichtcomfort en veiligheid te verhogen en door alle toepassingen naadloos te laten samenwerken. Gebouwen met Niko zijn efficiënter, laten zich controleren vanop afstand en interageren binnen grotere ecosystemen. Niko is een Belgisch familiebedrijf uit Sint-Niklaas met 700 werknemers en 10 Europese vestigingen.

Bij Niko is er één vraag die ons elke dag bezighoudt: 'Hoe kunnen we gebouwen beter laten werken voor jou?'

**Niko Nederland BV**  
Schorsweg 4  
8171 ME Vaassen  
sales.nl@niko.eu  
Tel 088-0159600  
[www.niko.eu](http://www.niko.eu)

**niko**  
*Illuminating ideas.*